

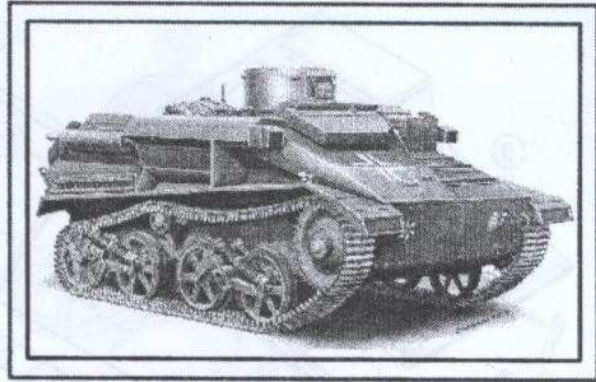

# Funk- und Beobachtungspanzer auf Fahrgestell Panzerkampfwagen Mk.VI(e)



cat. #72519

1/72 scale

## Parts

Rubber tracks



Etched Parts

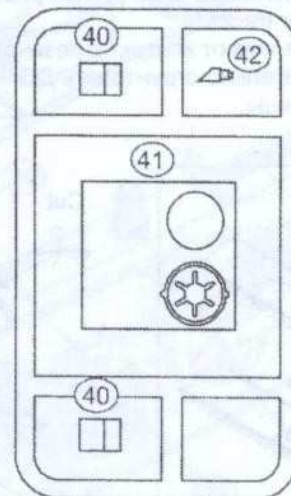
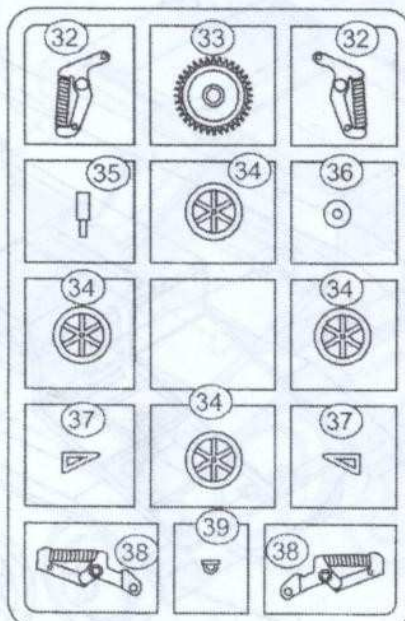
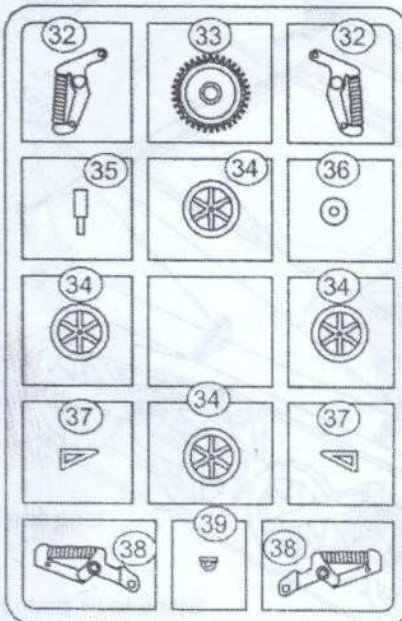
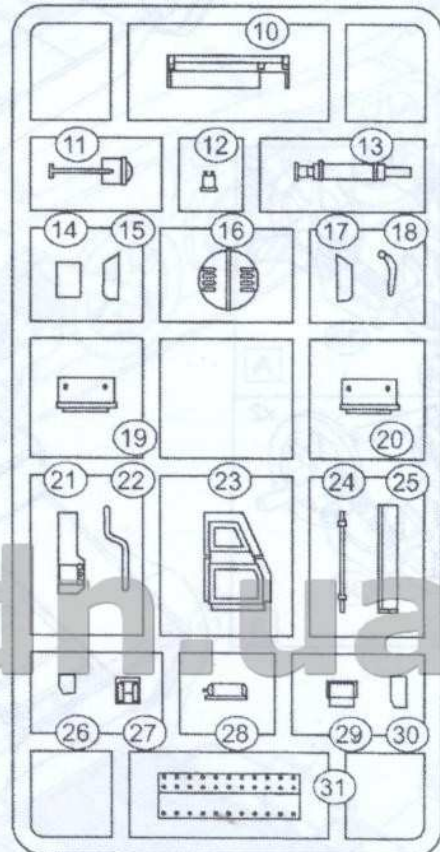
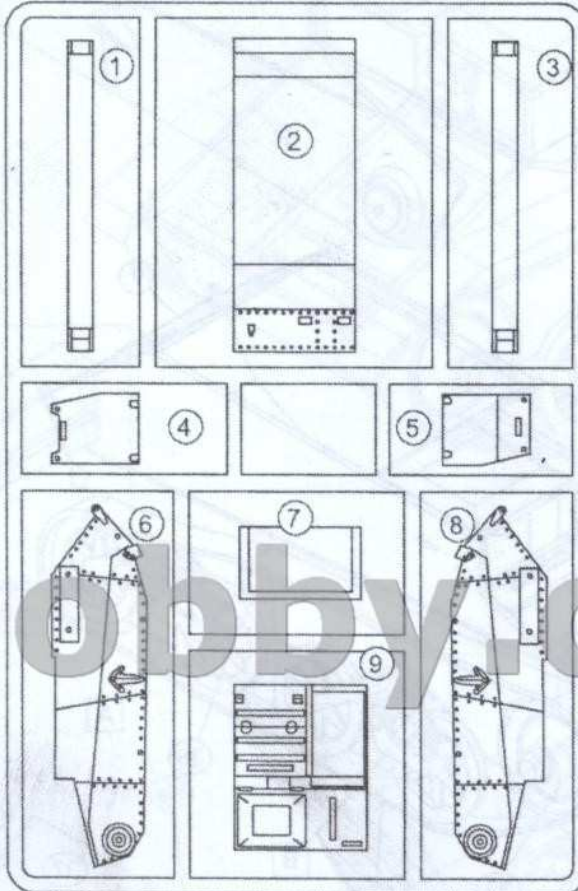
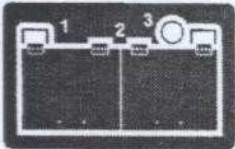



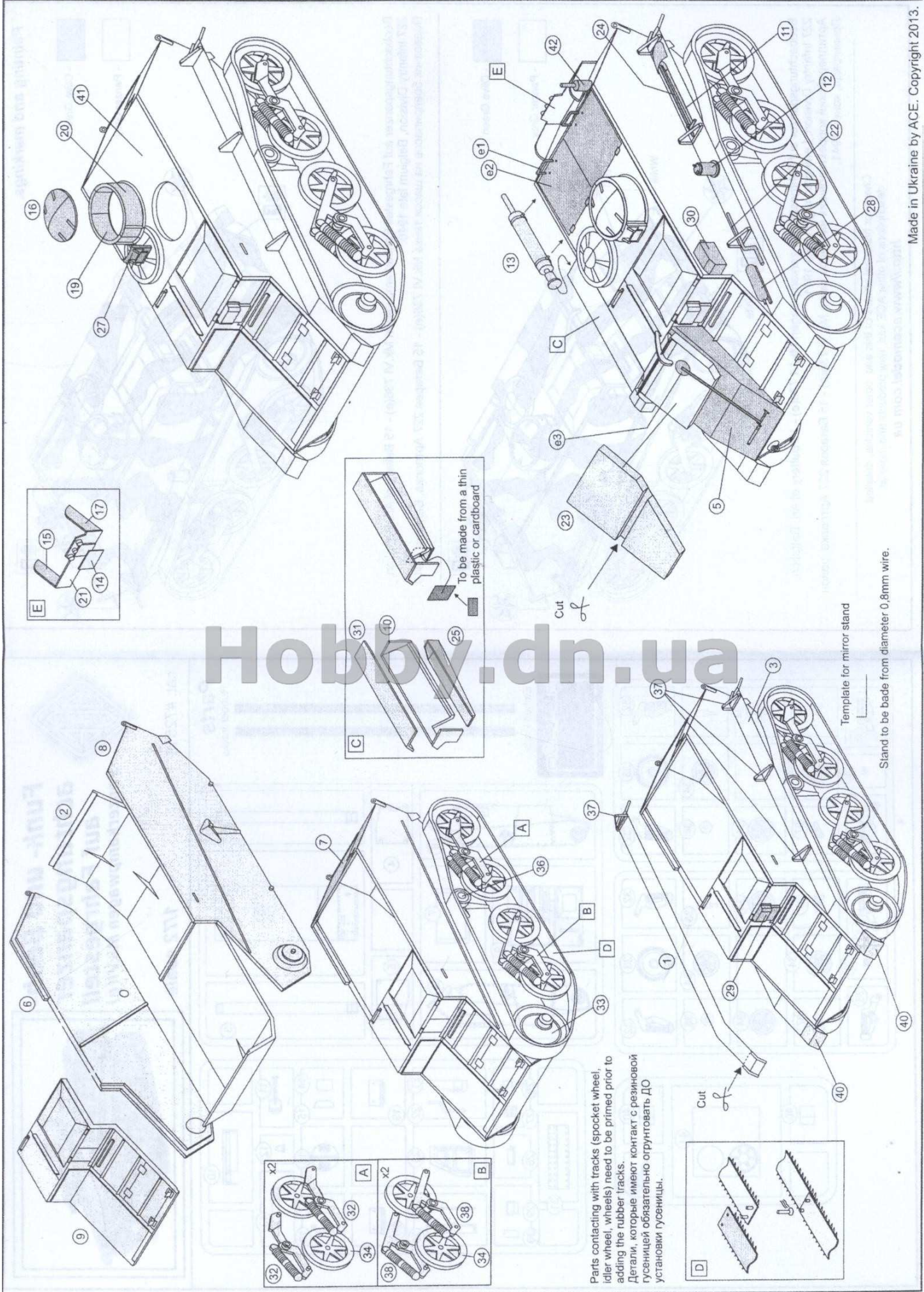

Parts contacting with tracks (sprocket wheel, idler wheel, wheels) need to be primed prior to adding the rubber tracks.  
 Детали, которые имеют контакт с резиновой гусеницей обязательно грунтовать ДО установки гусеницы.

Template for mirror stand

Stand to be made from diameter 0,8mm wire.



## Painting and markings.

-  - Olive Green
-  - Panzer Grey

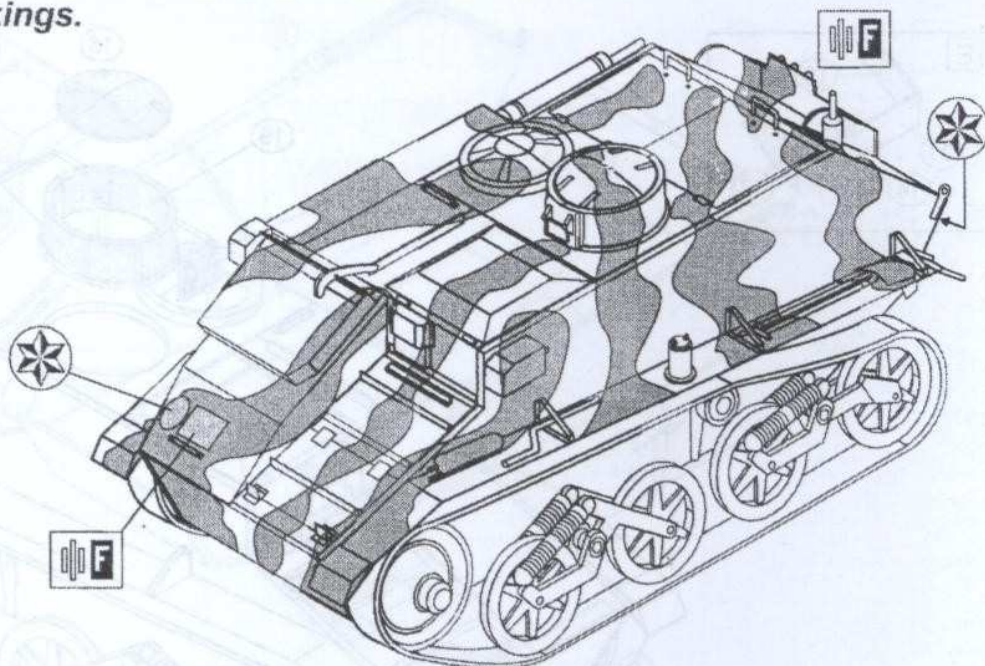

Beobachtungspanzer auf Fahrgestell Panzerkampfwagen Mk.VI 736(e) - 15 Battery of Art. Battalion, 227 Infantry Division, Belgium late 1940.  
 Подвозчик боеприпасов на шасси танка Mk.VI 736(e) - 15 Батарея 227 Артполка, Бельгия. 1940.

-  - Olive Green
-  - Panzer Grey

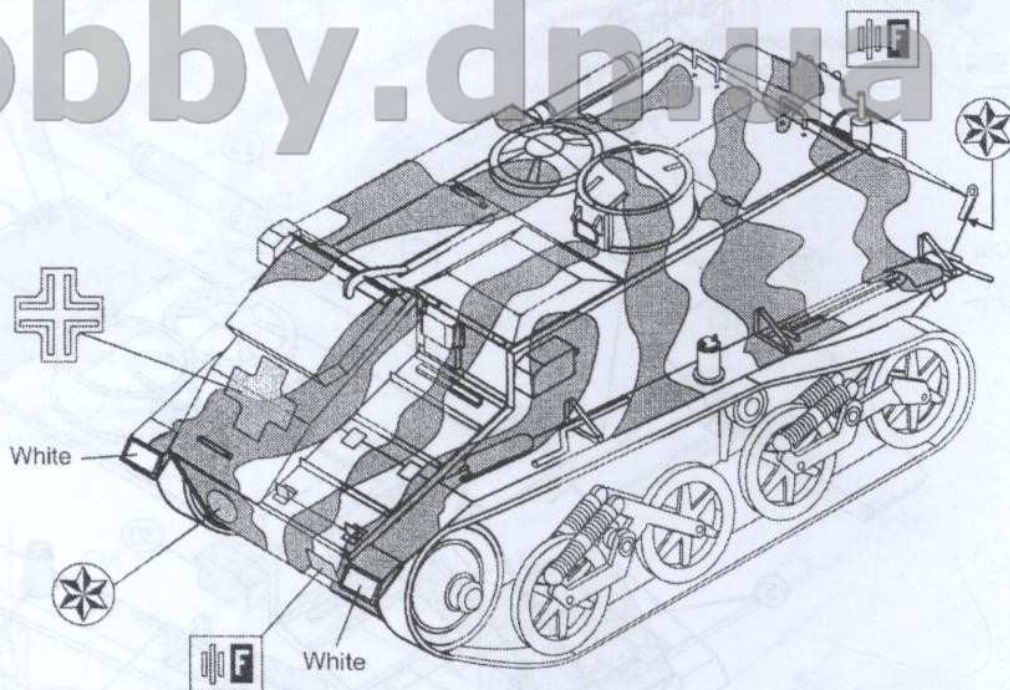

Beobachtungspanzer auf Fahrgestell Panzerkampfwagen Mk.VI 736(e) - 15 Battery of Art. Battalion, 227 Infantry Division, Leningrad region, late 1941.  
 Артиллерийский корректировщик на шасси танка Mk.VI 736(e) - 15 Батарея 227 Артполка, район Ленинграда, конец 1941.

Check for historical photos of this and other vehicles, detailed descriptions of other ACE kits, new products and more at:  
<http://www.acemodel.com.ua>