

Gloster Gauntlet Mk.I, Mk.II

History in brief

The Gloster S.S.18 first flew in January 1929. The Gauntlet was a development of the Gloster S.S.19B design, which originally mounted six machine guns (four in the wings and two in the fuselage), the original S.S.19 prototype being re-engined with a Bristol Mercury VIS engine, first flying in this form in 1933. On testing the S.S.19, the Air Ministry placed an order for 24 aircraft in September 1933, to be named the "Gauntlet".

This initial order was followed up with orders for the revised Gauntlet Mk. II. This new model used a revised construction method based on that used by Hawker following Hawker's takeover of Gloster, as this was much easier to build and repair than Gloster's welded structure. A total of 204 Mk IIs were produced in the UK.

Plastic parts/Plastikové díly

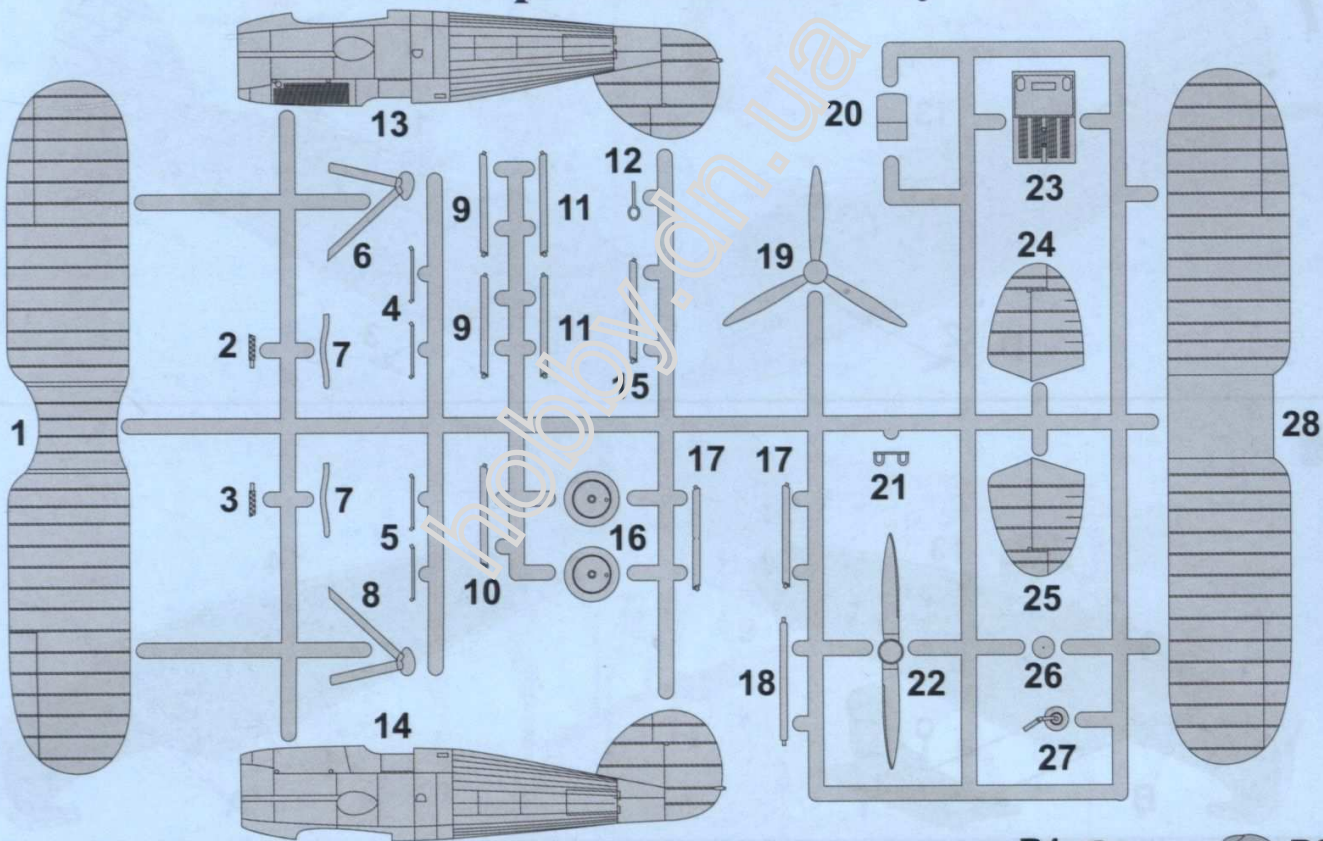

Clear parts/
Průhledné díly

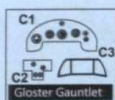

Metal parts/
Kovové díly



Resin parts/
Resinové díly

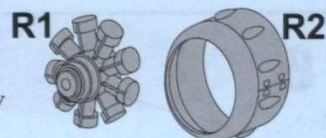

Symbols/Symboly

Drill hole Vyvrtat	Cyanoacrylate Vteřinové lepidlo	Remove Odstranit	Reduce Zbrousit
Make new Vyrobit	Option Volba	Bend Ohnout	Putty Tmel

	Colour name	Humbrol		Colour name	Humbrol
A	Black	H33	F	Tyre	H85
B	Interior Green	H76	G	Silver	H11
C	Aluminium	H56	H	Rust	H113
D	Gunmetal	H53	I	Red Brown	H100
E	Leather	H62	J	Natural Wood	H110

Assembly instructions

1

Cyanoacrylate
Vteřinové lepidlo

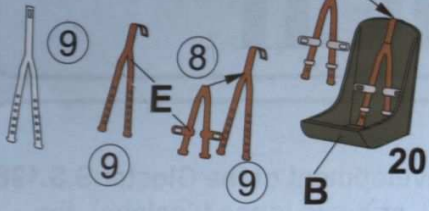

2

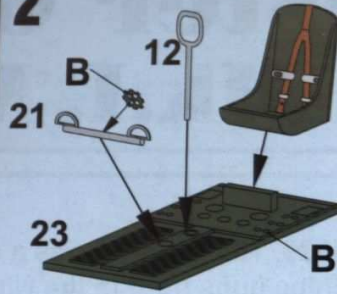

3

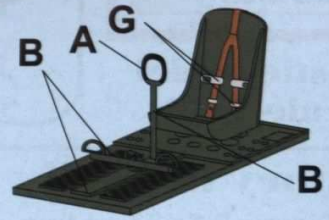

4

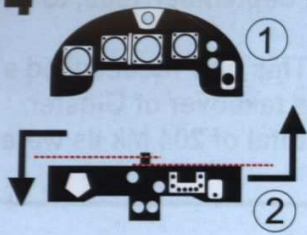

5

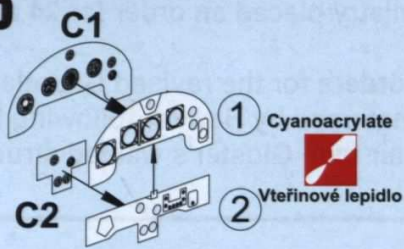

6



7

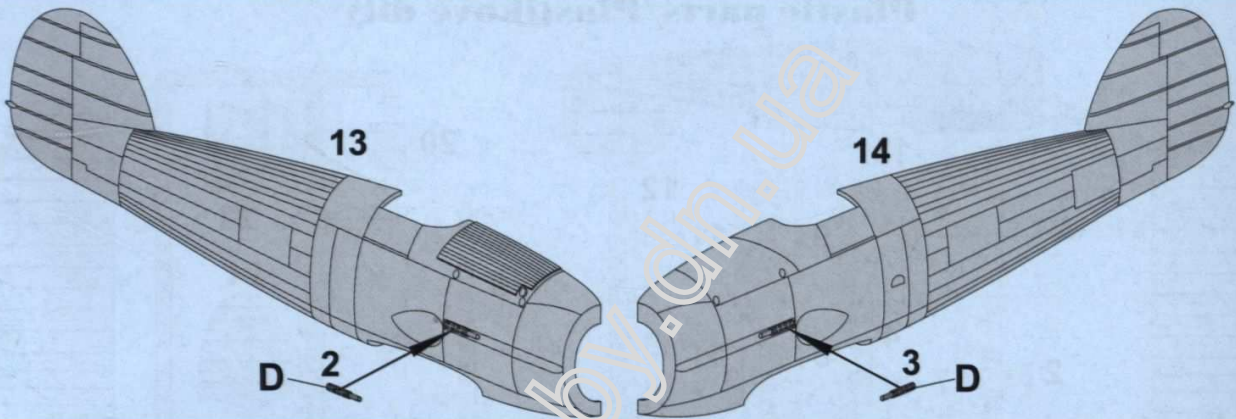

8

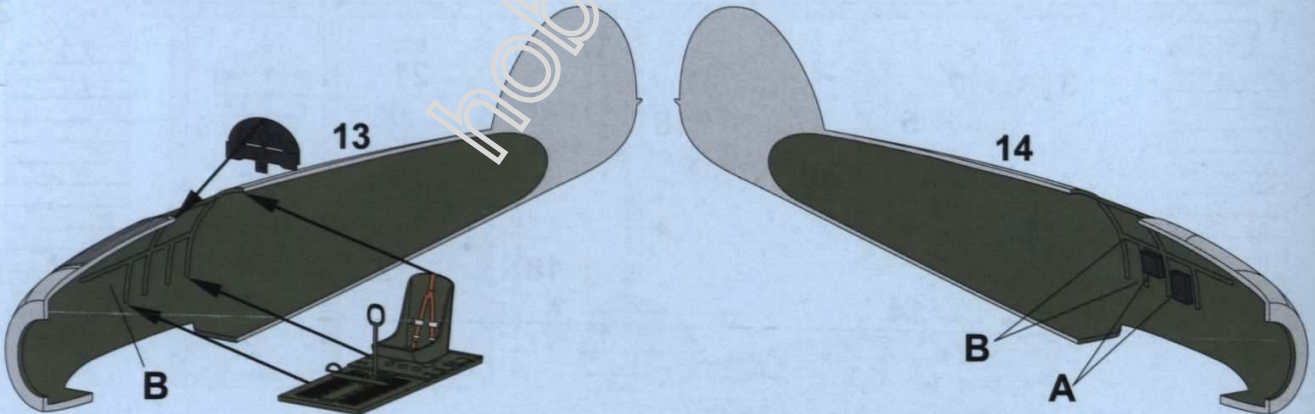

9

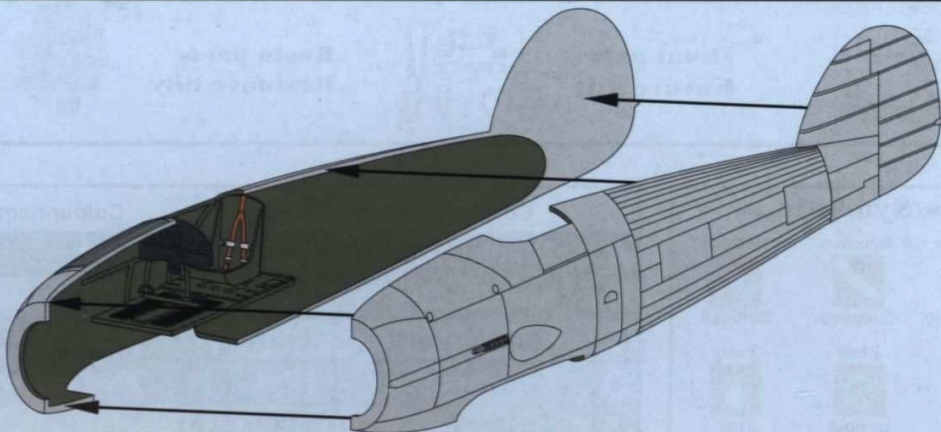

Assembly instructions

10

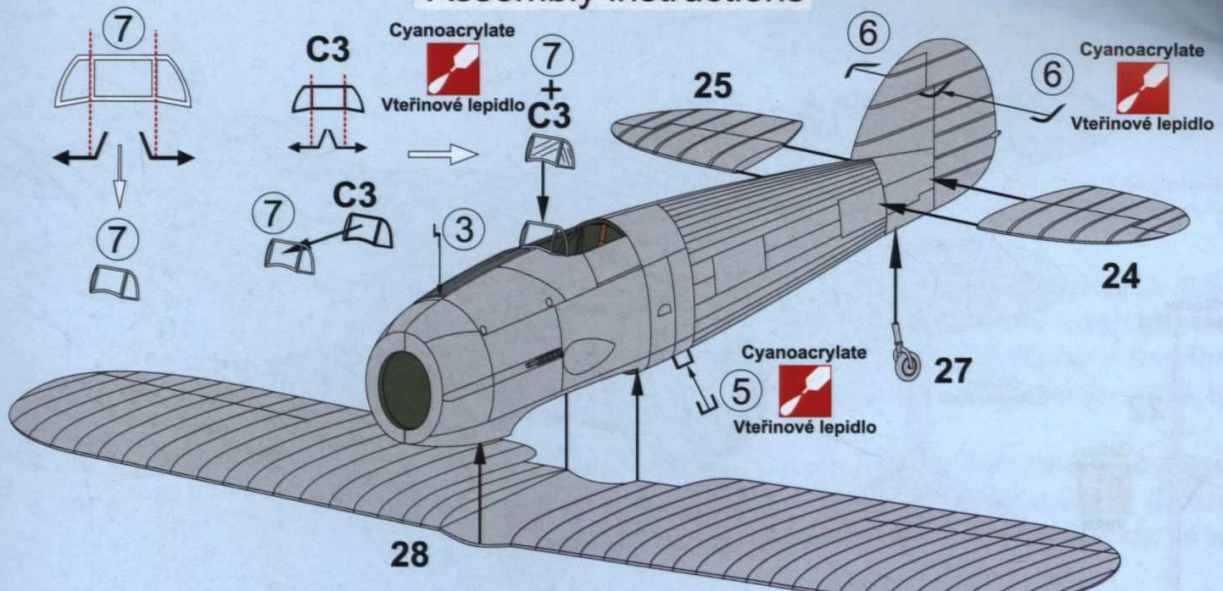

11

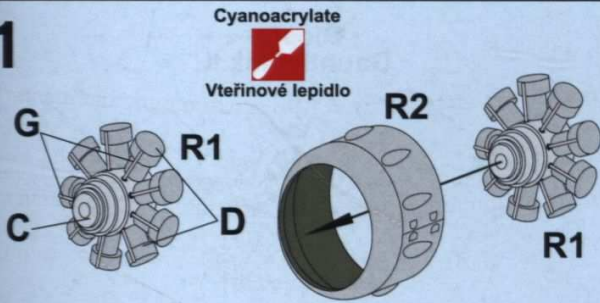

12

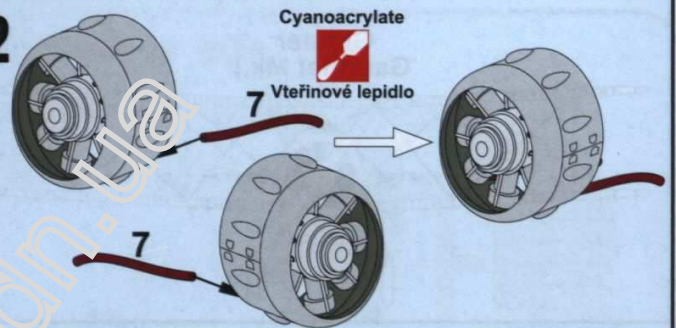

13

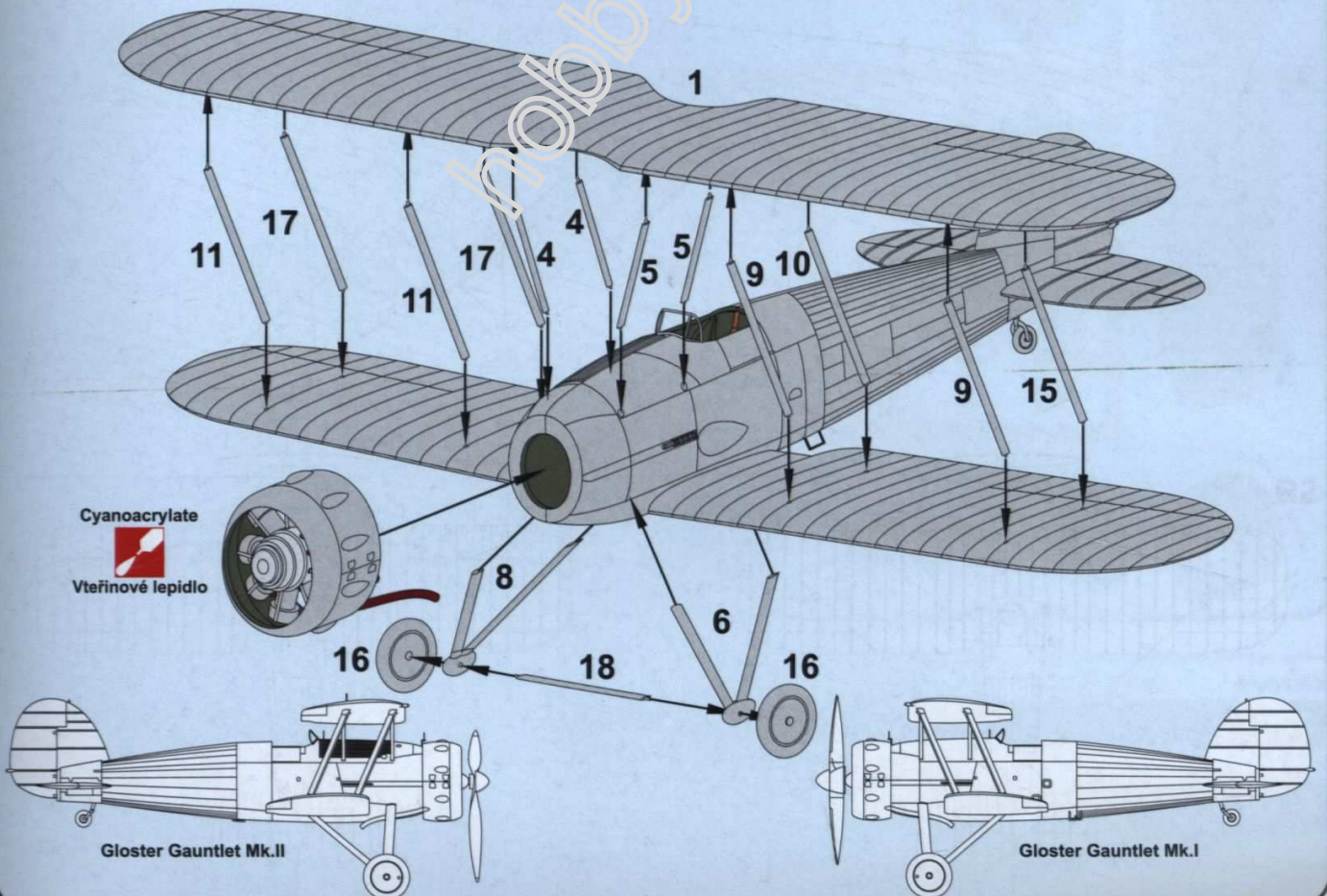

14

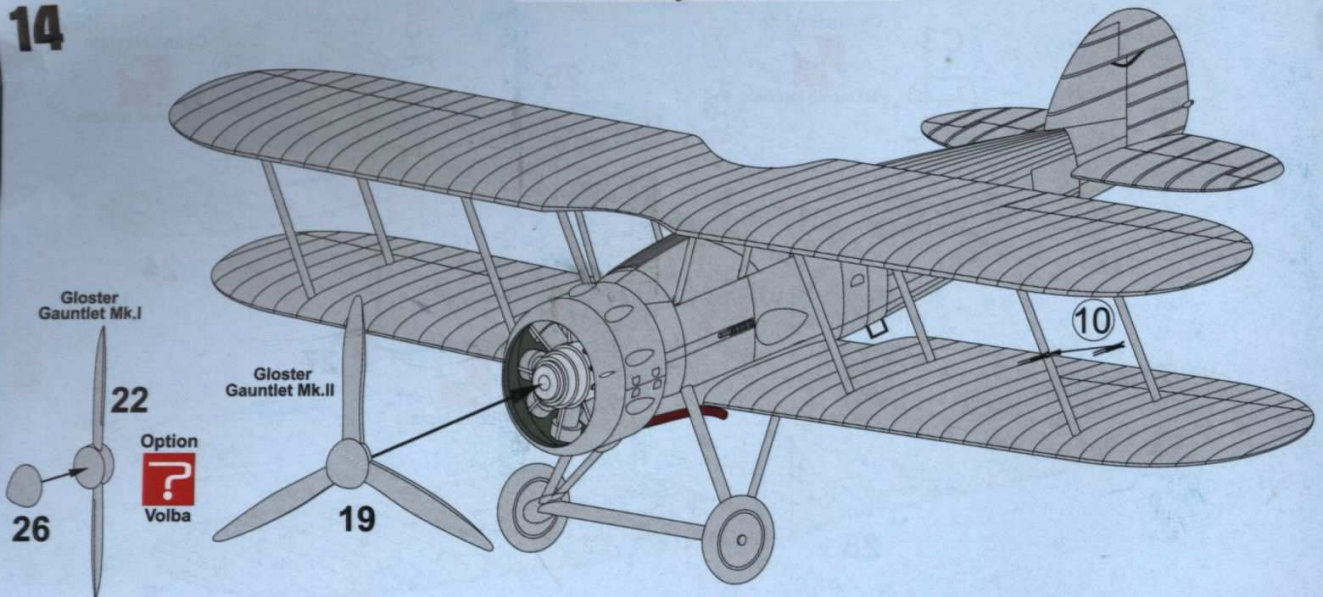

15

Rigging

