









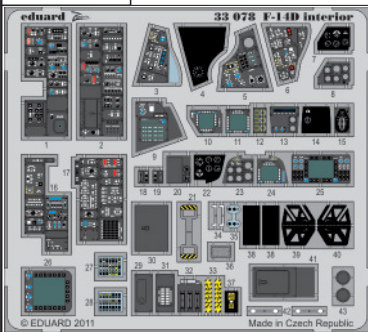

F-14D interior S.A.



33078

1/32 scale detail set for TRUMPETER • sada detailů pro model 1/32 TRUMPETER



-  APPLY EXPRESS MASK AND PAINT BEFORE GLUING
POUŽIT EXPRESS MASK NABARVIT PŘED SLEPENÍM
-  SYMMETRICAL ASSEMBLY
SYMETRICKÁ MONTÁŽ
-  REMOVE
ODSTRANIT
-  GRIND
OBROUSIT
-  DRILL HOLE
VRTAT OTVOR
-  BEND
OHNOUT
-  OPTION
VOLBA
-  REPLACE
NAHRADIT

 ORIGINAL KIT PARTS
PŮVODNÍ DÍLY STAVEBNICE

 PHOTO-ETCHED PARTS
LEPTANÉ DÍLY

 PARTS TO BE REMOVED
DÍLY K ODSTRANĚNÍ

 FILL
TMELIT

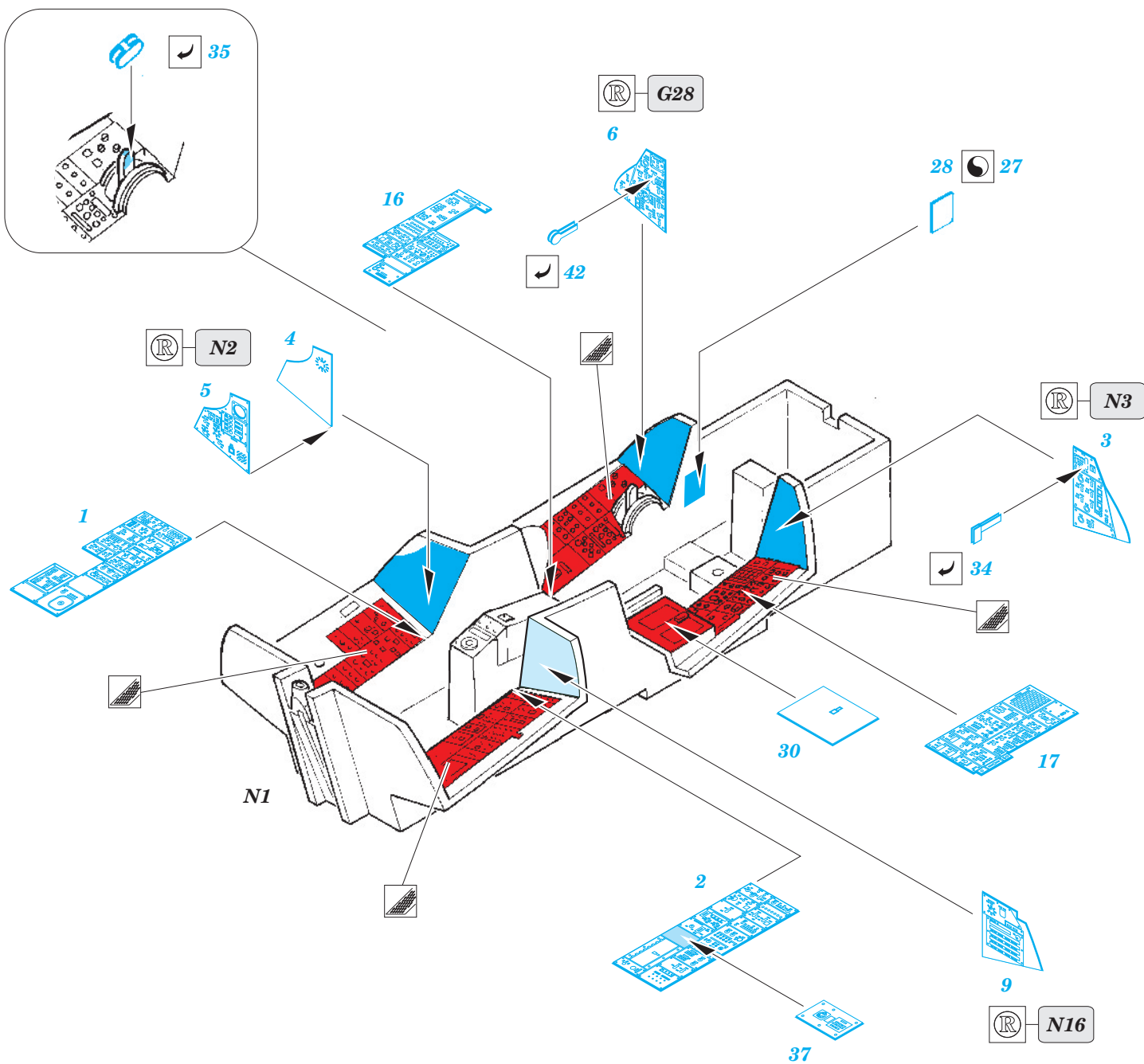

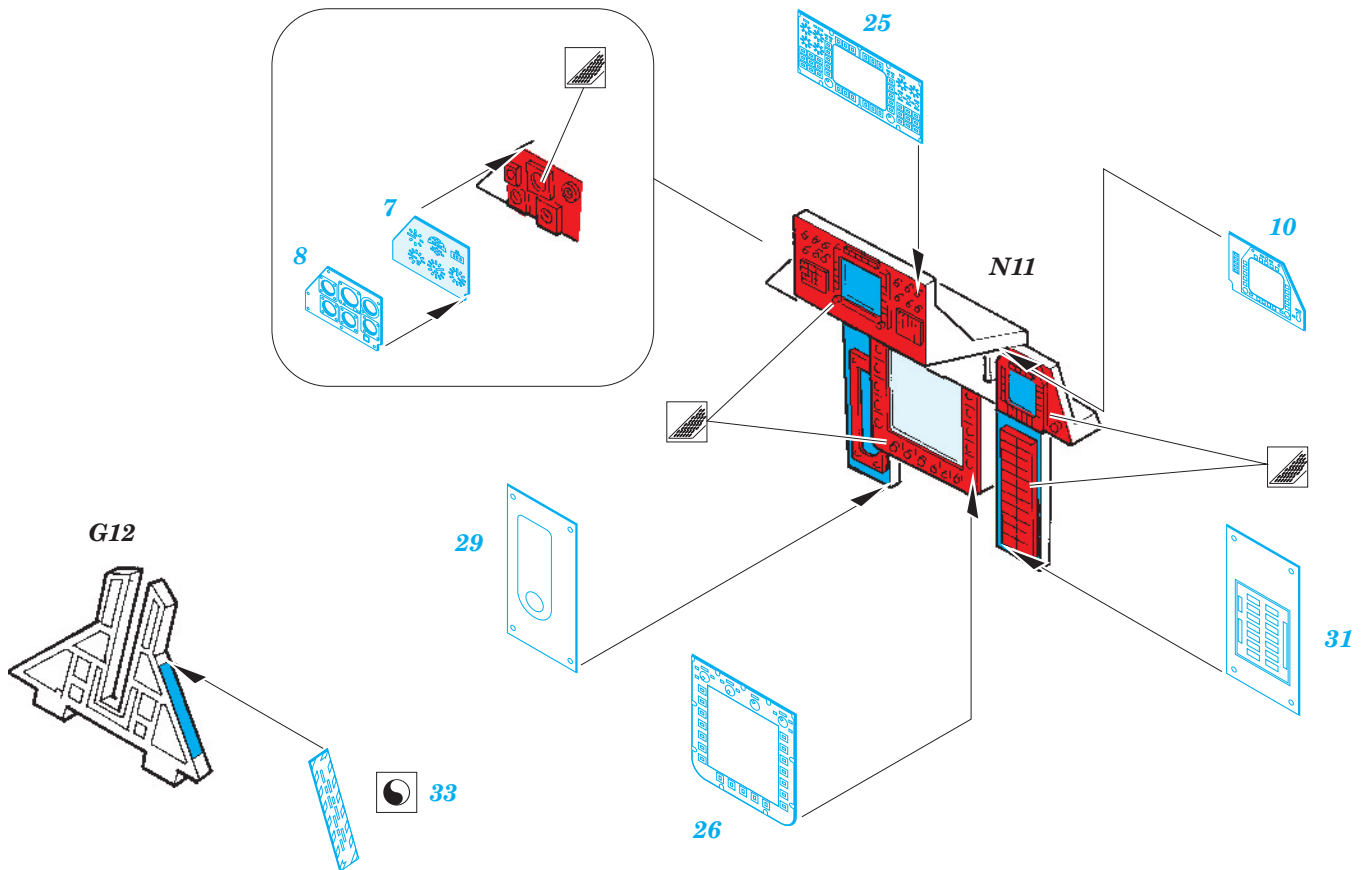
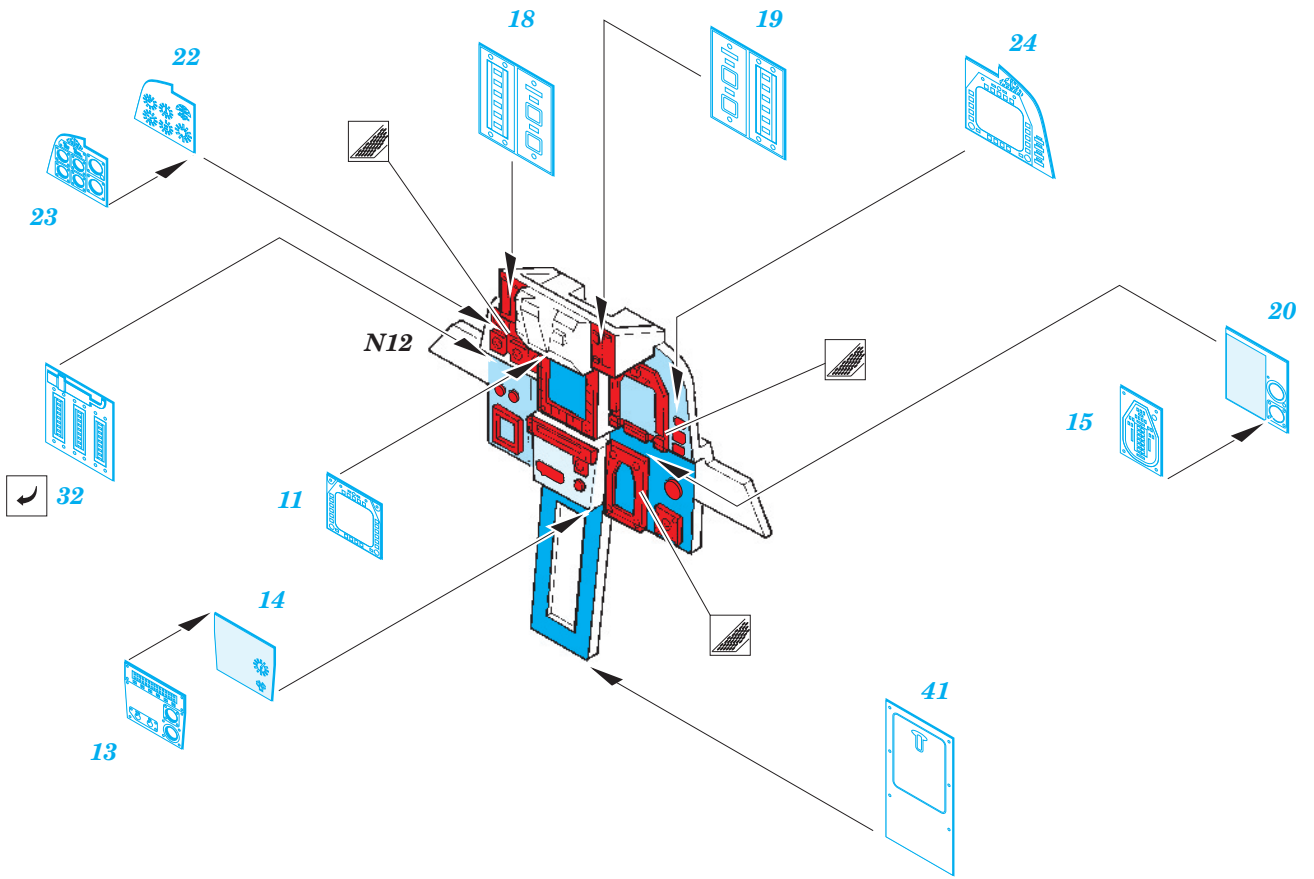

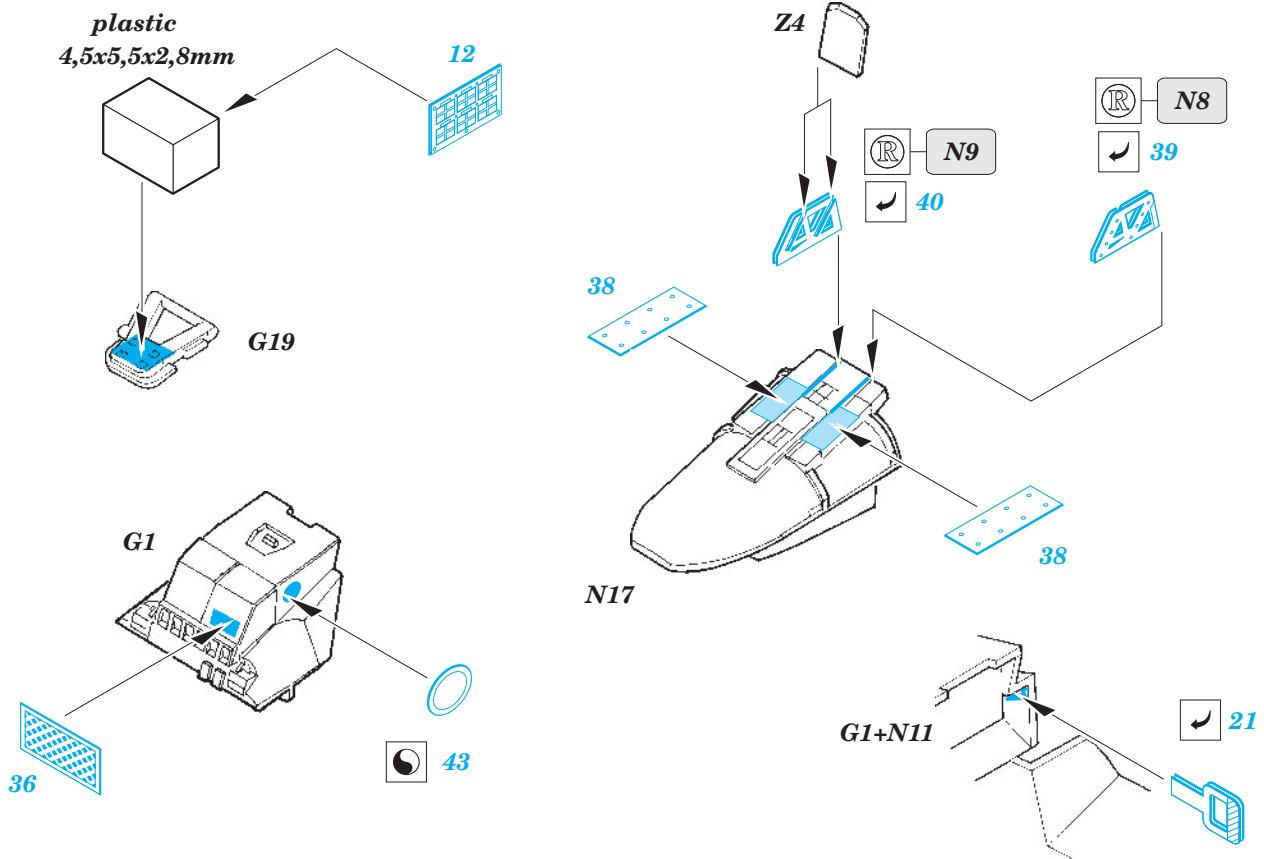

PARTS WITH GLUE • DÍLY OPATŘENÉ LEPIDLEM

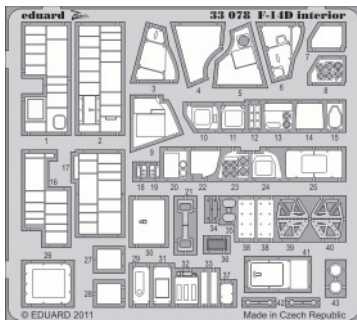

1. Separate the etched components from their frames on the protective paper. Removal from the paper is done only after separation of the parts from the frames.
1. Samolepicí díly oddělujte od rámečku na podkladovém papíře. Po oddělení je sejměte z krycího papíru.

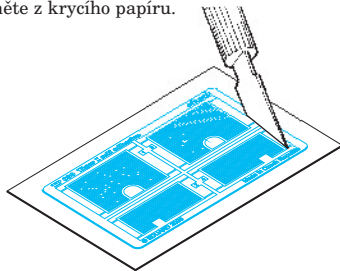

2. Do not inadvertently place etched components on an unwanted surface. Attempts to remove will result in damage to your part.
2. Nepokládejte samolepicí díly na volné plochy. Pokud je omylem přilepíte, při pokusu o odlepení dojde k poškození dílu.

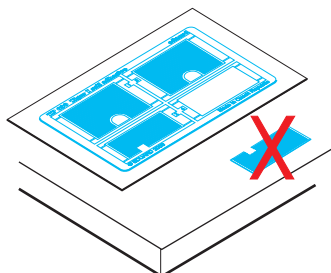

3. Do not touch the adhesive areas of the etched components.
3. Nesahejte na části dílů, na kterých je naneseno lepidlo.

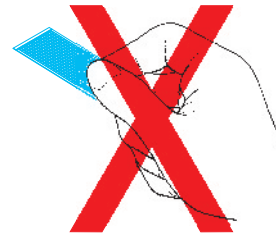

4. Hold the parts by the edges, or at areas free of adhesive.
4. Samolepicí díly berte za hrany nebo za části, na kterých není nanesen lepidlo.

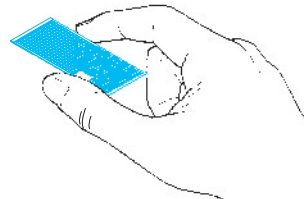

5. Lightly place the component in the desired location and position. Adjust as required. The component will be permanently affixed when pressed onto its intended location, its location can be adjusted.
5. Díl lehce položte do pozice, ve které má být nalepen. Upravte přesnou pozici a přimáčkněte. Díl dokonale přilne až po přimáčknutí, před přimáčknutím lze dílem opatrně manipulovat.

