

672 070 IRIS-T

eduard BRASSIN

1/72 scale

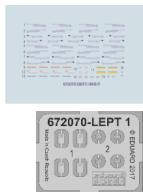
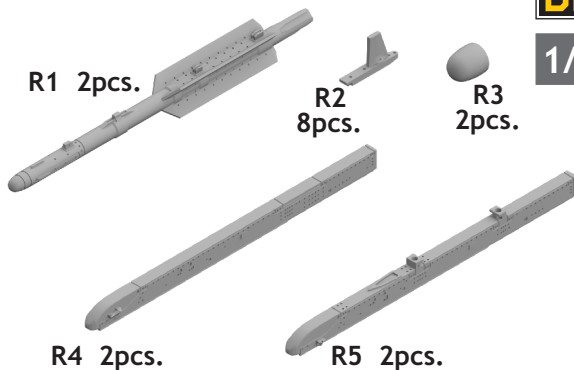

COLOURS

GSI Creos (GUNZE)			Mr.METAL COLOR	
AQUEOUS	Mr.COLOR		Mr.METAL COLOR	
[H 4]	[C 4]	YELLOW	[MC213]	STAINLESS
[H308]	[C308]	GRAY		

This product contains metal and resin detail parts for upgrading scale plastic models. When selecting this set make sure that it is for the kit mentioned in product name as these sets are made specifically for that kit. When upgrading the model some cutting or corrections may be necessary for parts to fit accurately. **WARNING!** This set contains small and sharp parts. Work carefully in a ventilated and well-lit room. Safety glasses are recommended. This product is not suitable for children below 14 years of age.

Tento výrobek obsahuje leptané a odlévané detaily pro úpravu a vylepšení plastického modelu. Při výběru sady kovových detailů zkontrolujte, zda je určena pro model, který chcete upravit. Model, pro který je sada určena, je uveden u názvu výrobku. Pro přesnou aplikaci kovových a odlévaných dílů může být zapotřebí upravit díly upraveného modelu. **POZOR!** Sada obsahuje malé ostré díly. Pracujte ve větrané a dobře osvětlené místnosti. Doporučujeme použít ochranných brýlí. Tento výrobek není vhodný pro děti mladší 14 let.

eduard

435 21 Obrnice 170
Czech Republic

www.eduard.com



672 070 IRIS-T

1/72

BRASSIN

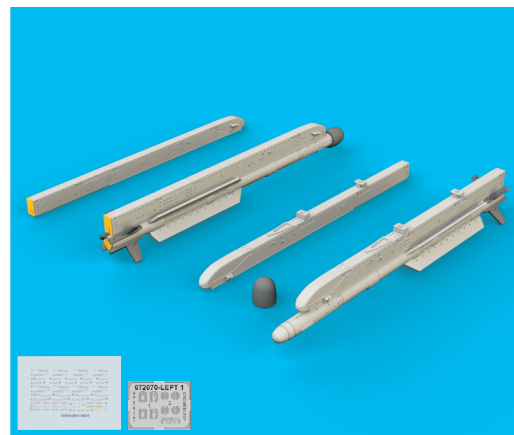





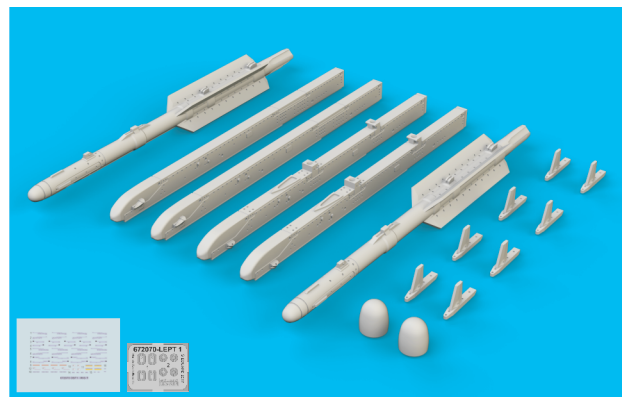



BRASSIN

eduard



BEST ~~BRASS~~ RESIN AROUND!

-  REMOVE
ODSTRANIT
-  GRIND
OBROUSIT
-  DRILL HOLE
VRTAT OTVOR
-  SYMMETRICAL ASSEMBLY
SYMETRICKÁ MONTÁŽ
-  SCRIBE THE PANEL AND HOLES
RYTI
-  REVERSE SIDE
OTOČIT
-  BEND
OHNOUT
-  OPTION
VOLBA
-  REPLACE
NAHRADIT

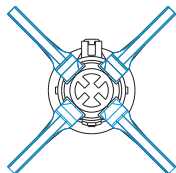

CORRECT POSITION

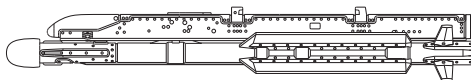

R5 - Lavett RB99 for JAS-39

CORRECT POSITION

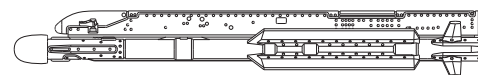

R4 - LAU-129 for F-16

 = 

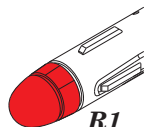

R1

?

1

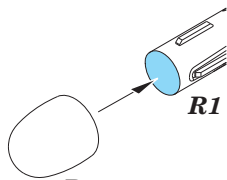

R3

R3 - WARHEAD COVER

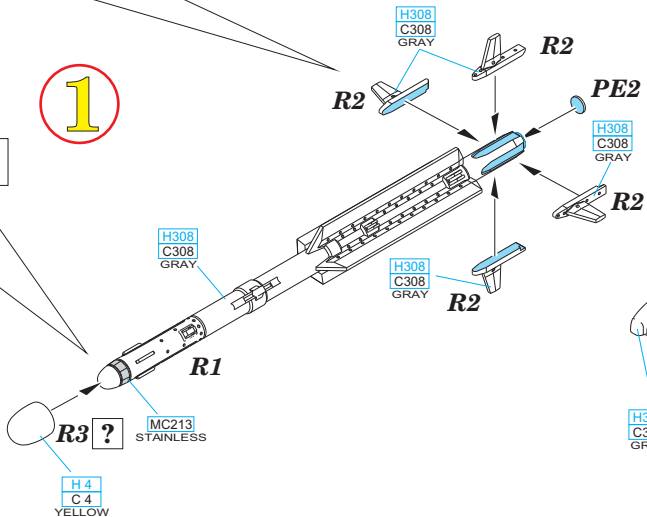

2

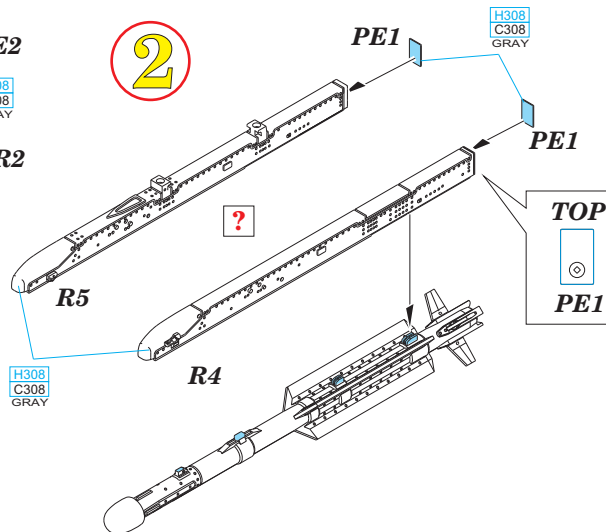

TOP

PE1

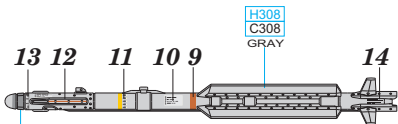

MC213
STAINLESS

R4 - LAU-129 for F-16

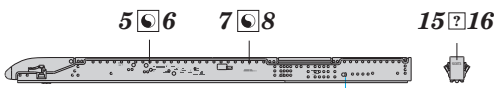

H308
C308
GRAY

R5 - Lavett RB99 for JAS-39

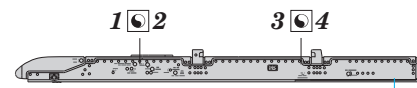

H308
C308
GRAY