

Sd.Kfz. 181 Pz.Kpfw.VI Ausf.E



Rye Field Model

RM-5010

Tiger I Middle Production

w/ Full Interior



Assembly Icon



OPTIONAL
选择



CEMENT
膠水



DO NOT CEMENT
不使用膠水



INSTANT CEMENT
瞬間接著劑



BEND
彎折



MAKE 2pcs
製作2組



OPEN HOLE
鑽孔



REMOVE
切除



BE CAREFUL
注意



APPLY DECAL
貼上水貼紙



Read carefully and fully understand the instructions before commencing assembly.

Supervising adult should also read the instructions if a child assembles the model.

When you used glue or paint, do not use near a naked flame, and use in a well-ventilated room.

When assembling this kit, tools including knives are used. Extra care should be taken to avoid personal injury.

Read and follow the instructions supplied with paints and/ or cement. Use plastic cement and paints only.

Keep out of reach of small children. Children must not be allowed to suck any part, or pull vinyl bag over the head.

在裝配前仔細閱讀說明並完全理解。小孩裝配時需成人看護且需仔細閱讀說明。

使用膠水和油漆時，應遠離火源並打開窗戶保持空氣流通。

製作時請格外注意工具刀和零件的鋒利尖銳部分，避免對身體造成傷害。

在使用膠水和油漆前仔細閱讀注意事項，按照說明正確使用膠水和油漆。

請將本品放在兒童接觸不到的地方，套件中的塑膠包裝袋會對兒童造成窒息的危險。

Parts

A x1

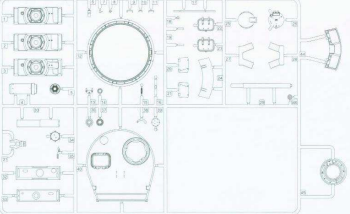

D x2

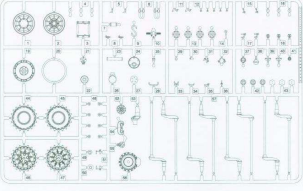

B x1

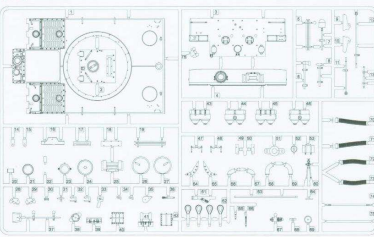

C x2

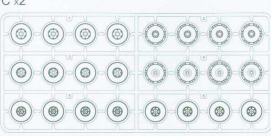

M x2

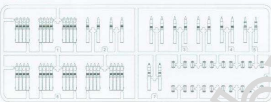

Z x1

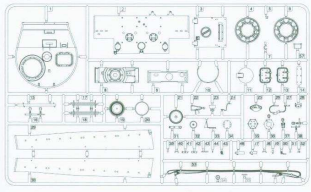

S x1

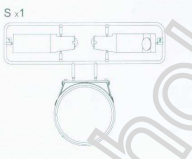

Lower hull x1

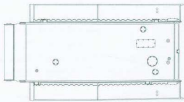

N x4



Track x192



Cable 45cm



T x1



H x1

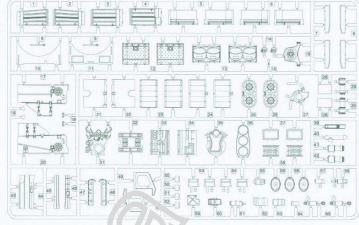

U x1

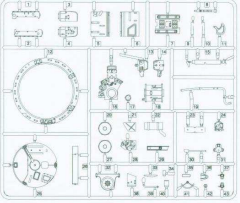

J x1

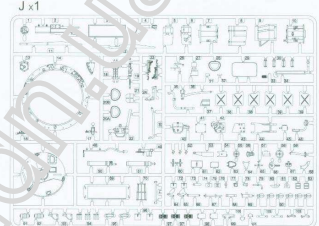

K x1

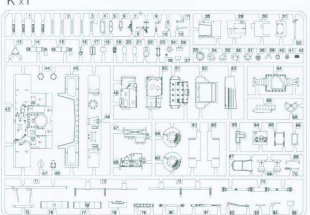

F x1

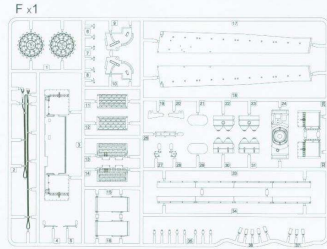

O x1

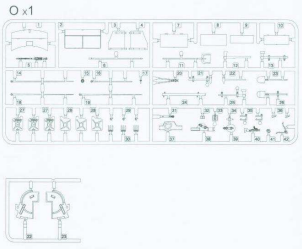

V x1



P x1



Y x1



Decal x1



217 217 217 217 217
342 342 342 ++
321 321 321



TIGER I Middle Production Model

Painting and Marking Guide

Color info and profiles by



- A.MIG 010 Dunkelgelb
- A.MIG 024 Washable White Camo
- A.MIG 033 Rubber & Tires
- A.MIG 035 Dark Tracks
- A.MIG 037 New Wood
- A.MIG 045 Gun Metal
- A.MIG 096 Crystal Pentacope Green

No.217, February 1944
Eastern Front

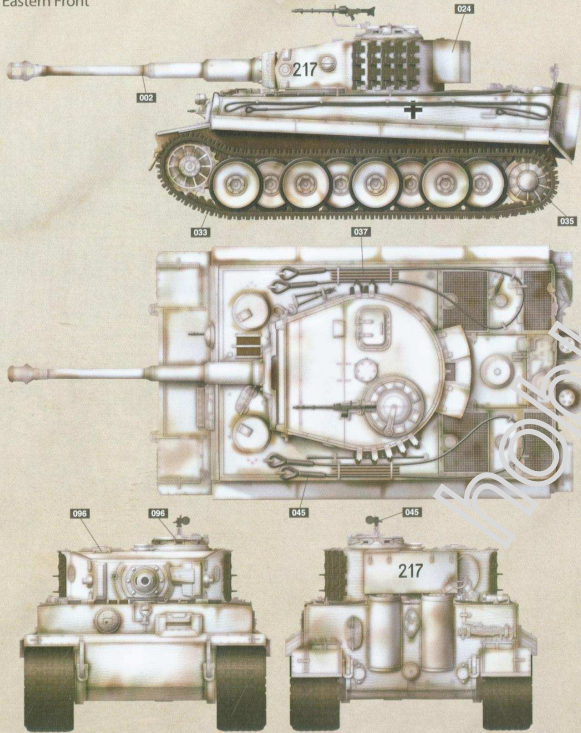

TIGER I Middle Production Model

Painting and Marking Guide

Color info and profiles by



- A.MIG 002 Oligrün Opt.2
- A.MIG 010 Dunkelgelb
- A.MIG 015 Schokbraun
- A.MIG 033 Rubber & Tires
- A.MIG 035 Dark Tracks
- A.MIG 037 New Wood
- A.MIG 045 Gun Metal
- A.MIG 096 Crystal Pentacope Green

No.342, Early Spring of 1944 Belgium/Mons

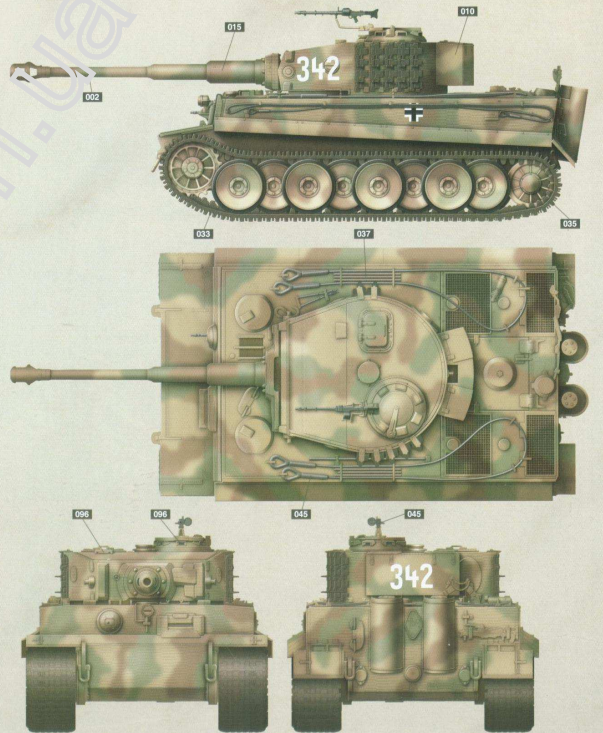



TIGER I Middle Production Model

Painting and Marking Guide

Color info and profiles by



| | | |
|---------------------------|-----------------------------------|------------------------|
| A.MIG 002 Olive/Grn Oyl.2 | A.MIG 010 Dunkelgelb | A.MIG 015 Schwarzbraun |
| A.MIG 033 Rubber & Tires | A.MIG 035 Dark Tracks | A.MIG 037 New Wood |
| A.MIG 045 Gun Metal | A.MIG 096 Crystal Periscope Green | |

No.321, June 1944 Northern France

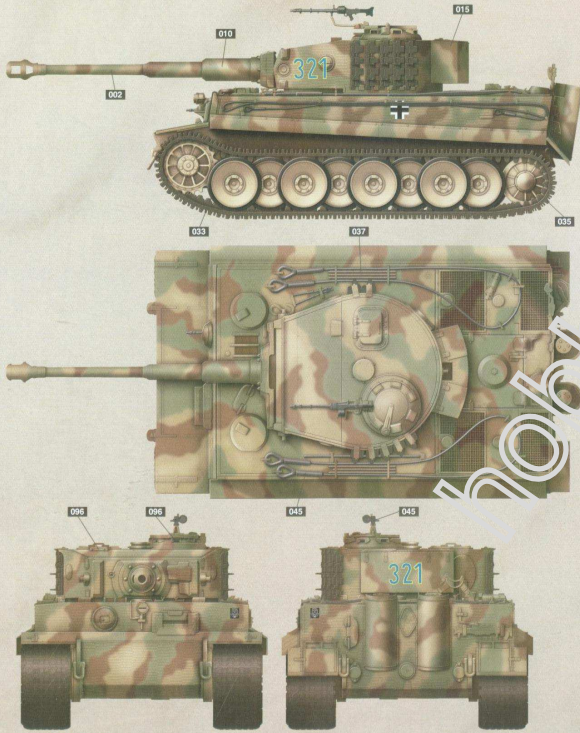

Color info and profiles by



Zimmerit

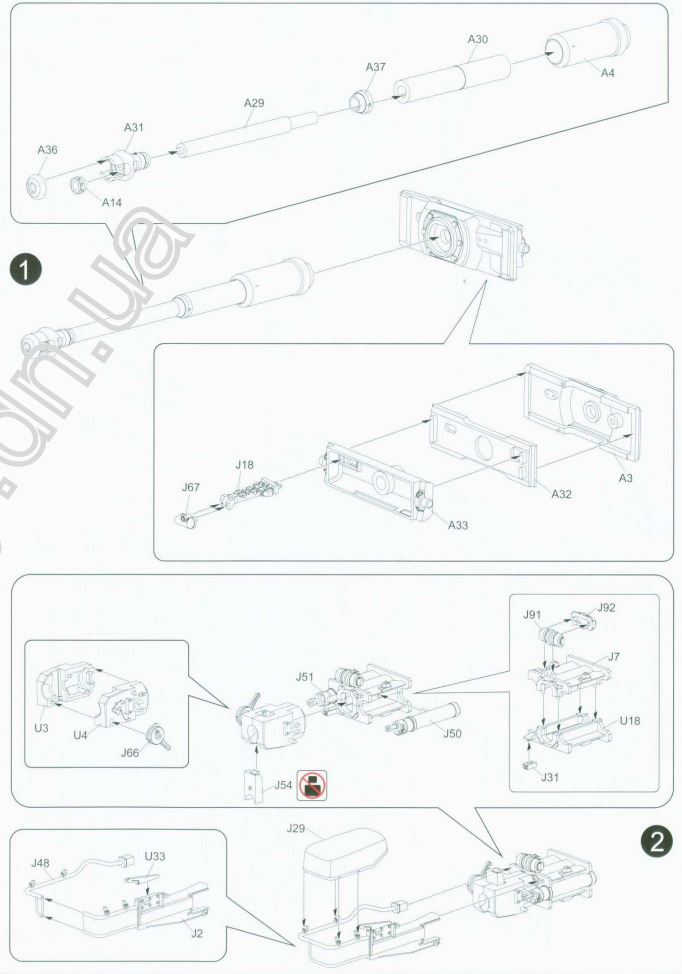
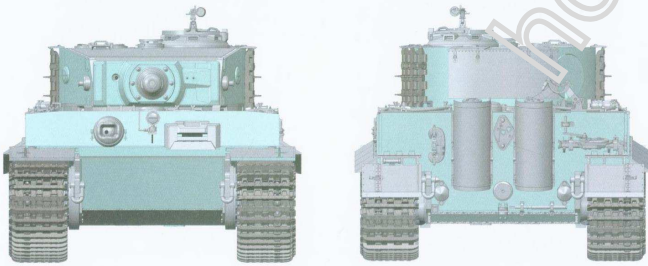
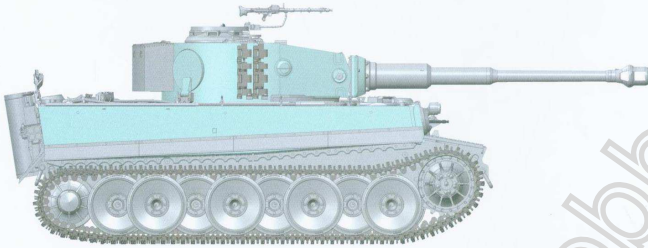
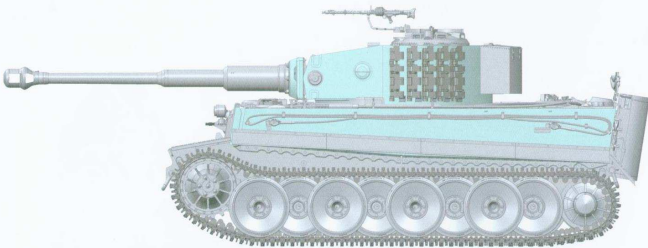

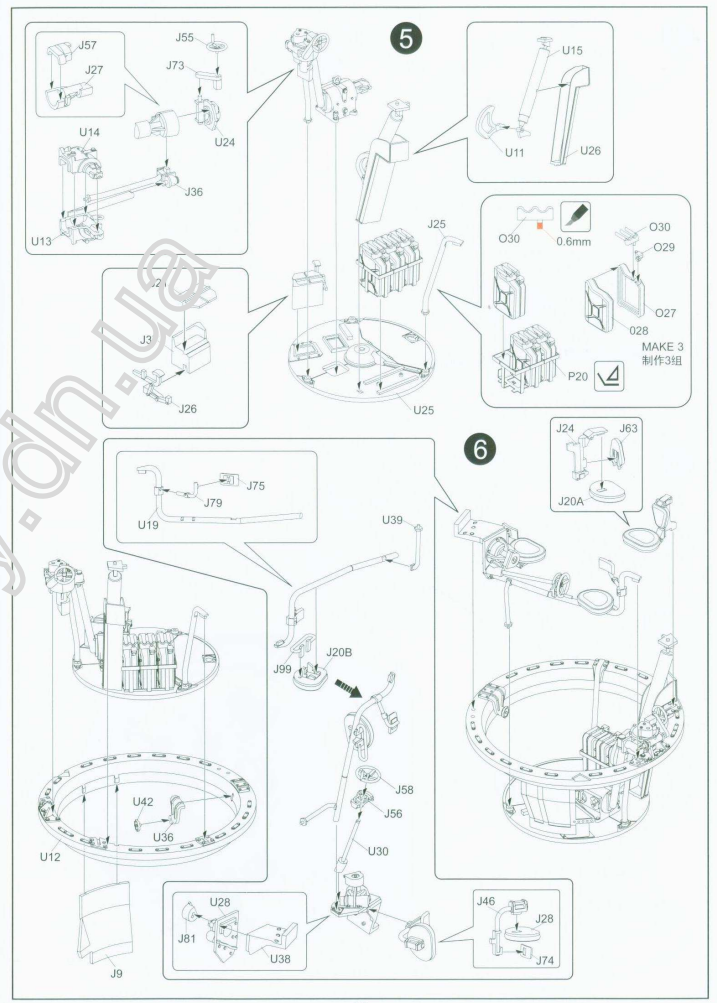
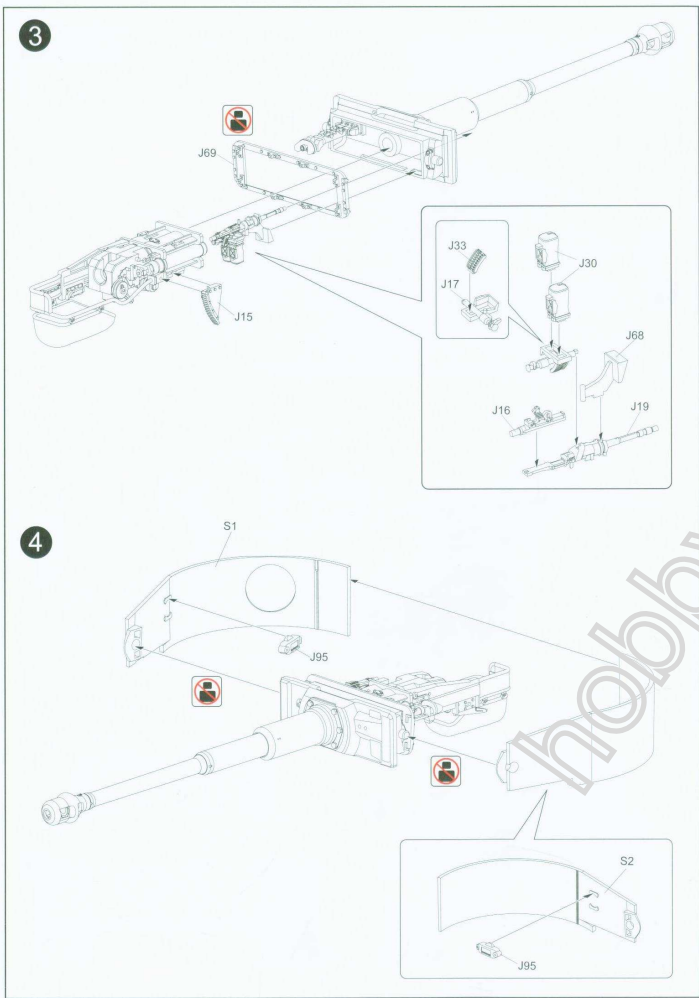

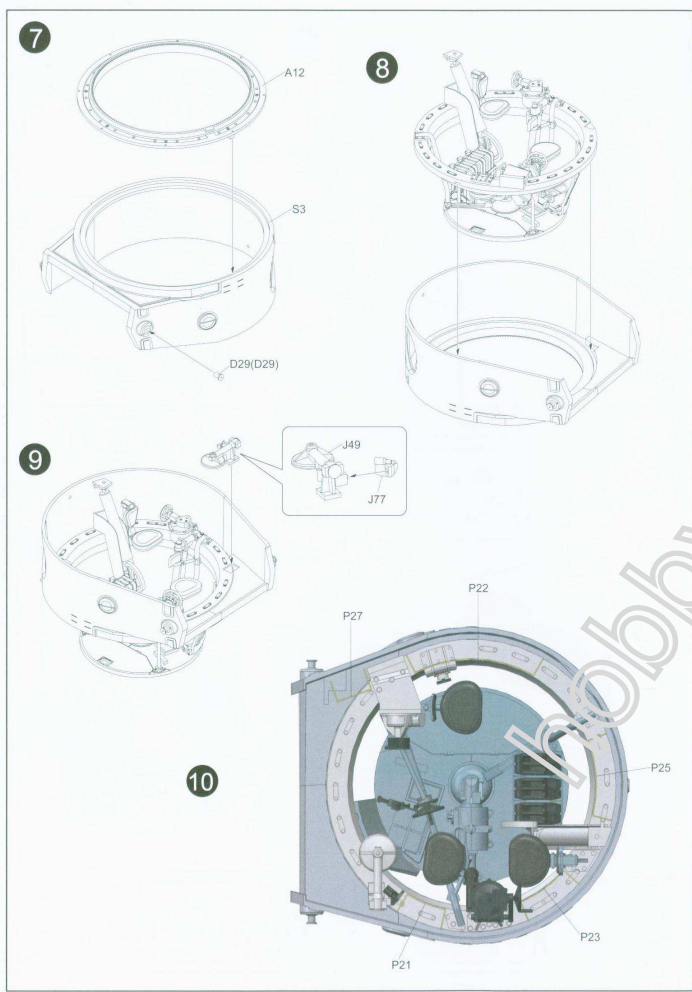

12

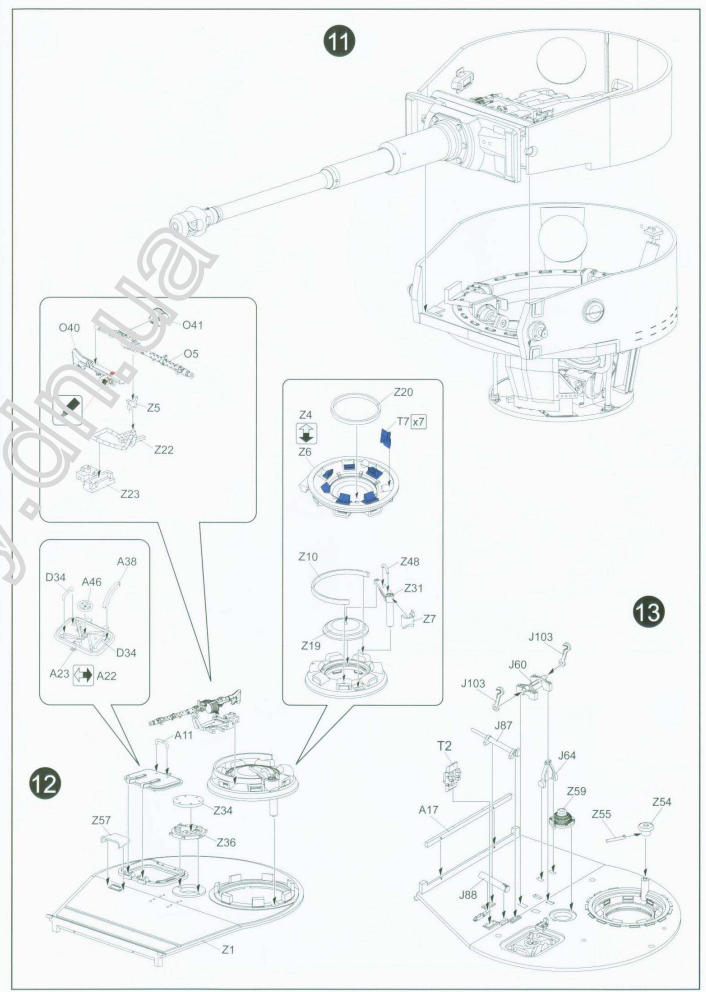

13

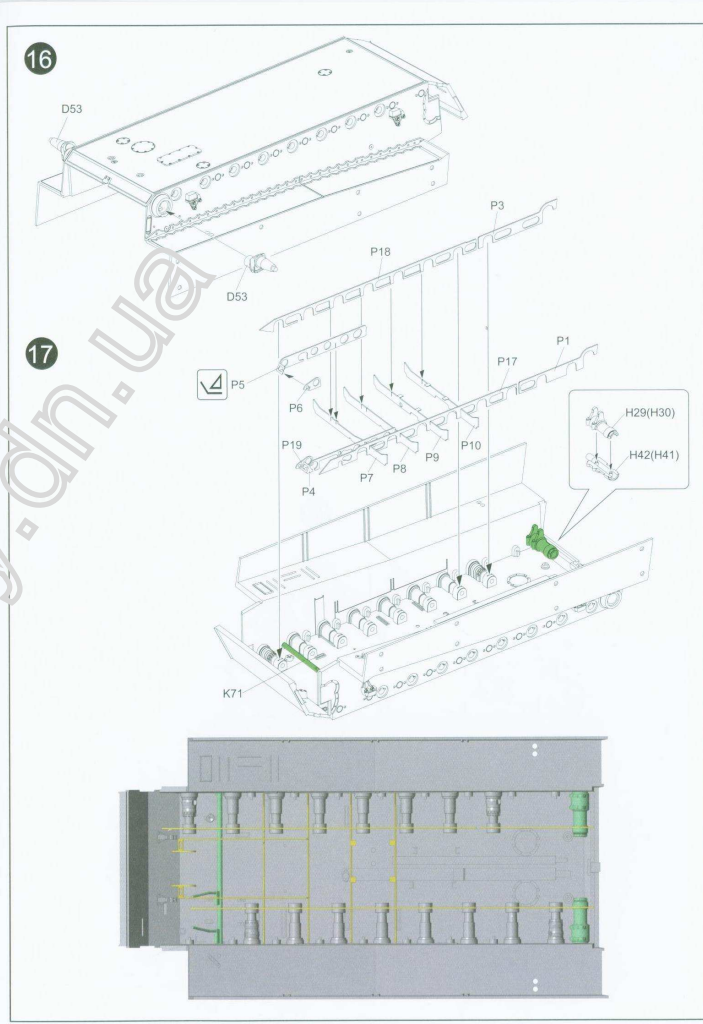
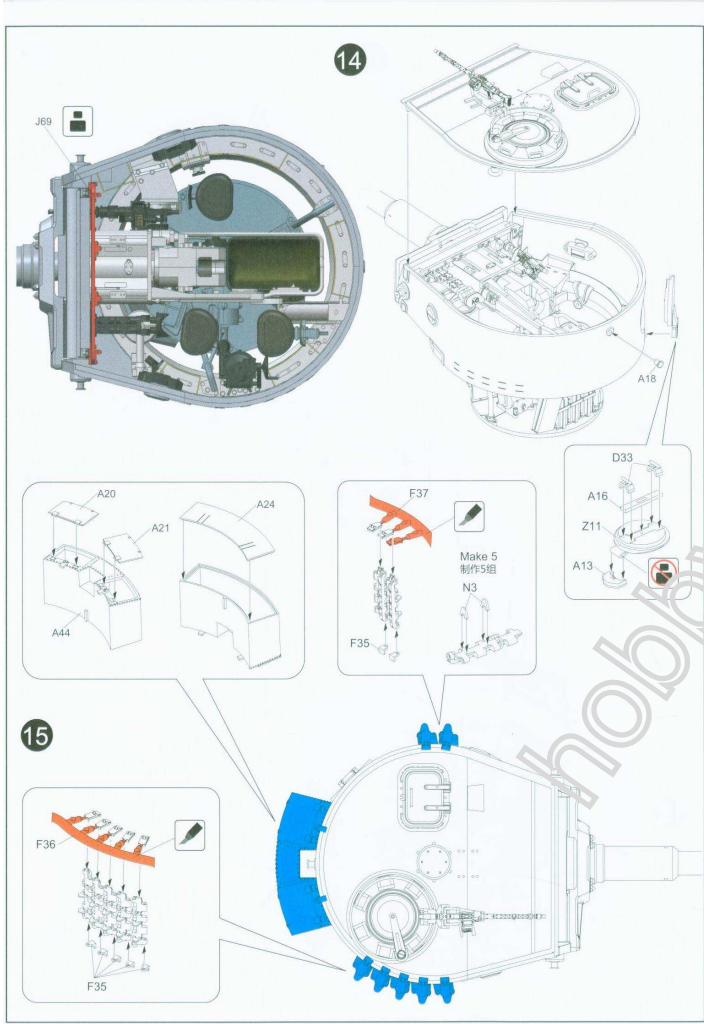

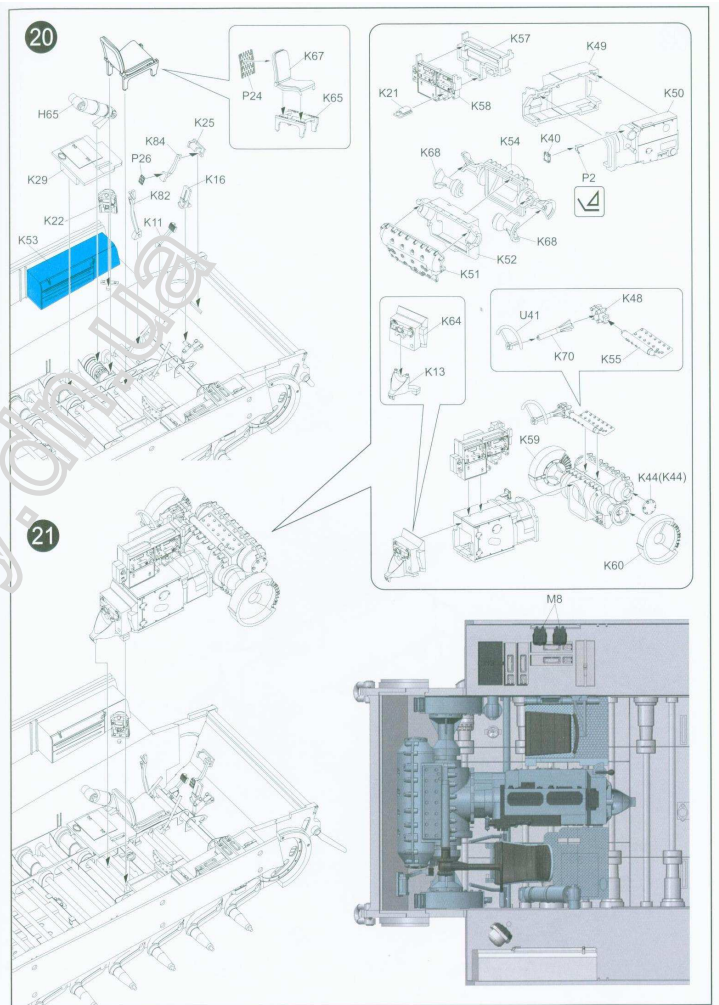
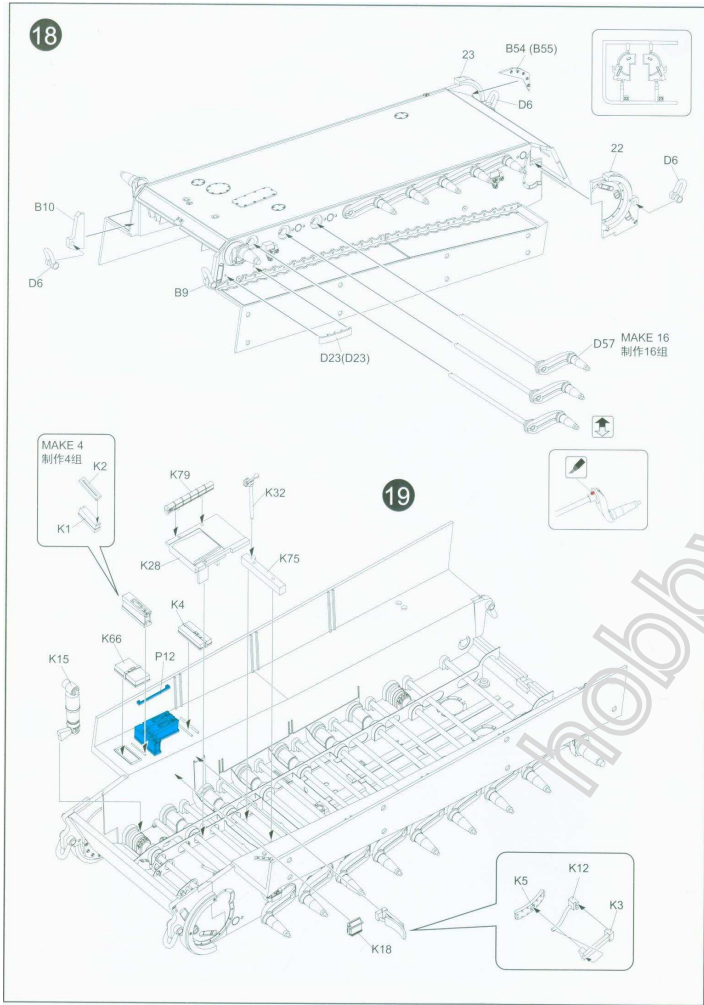

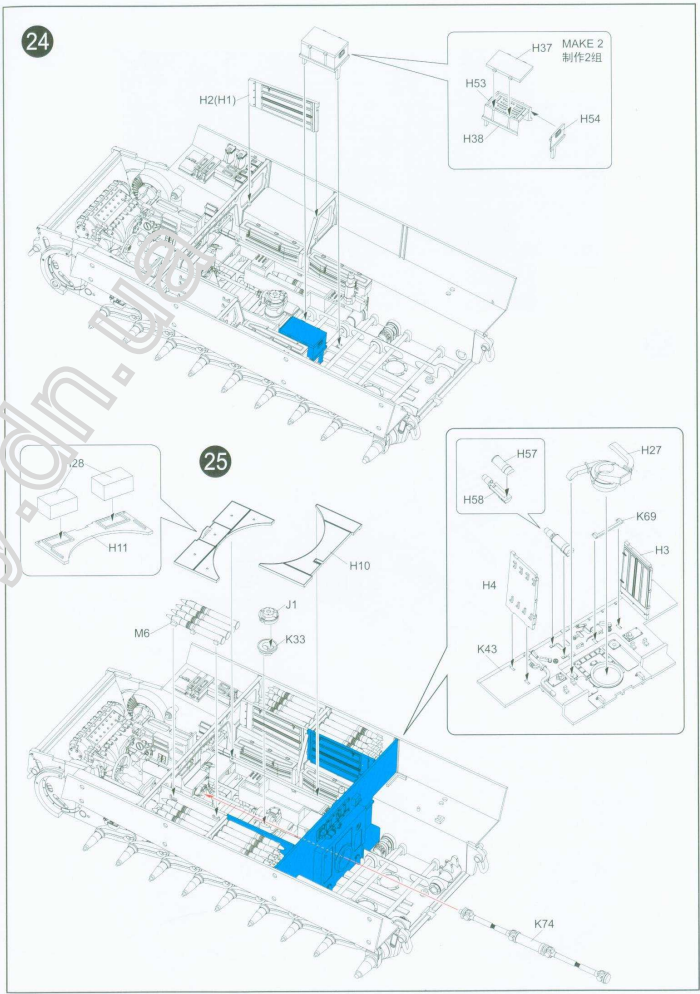
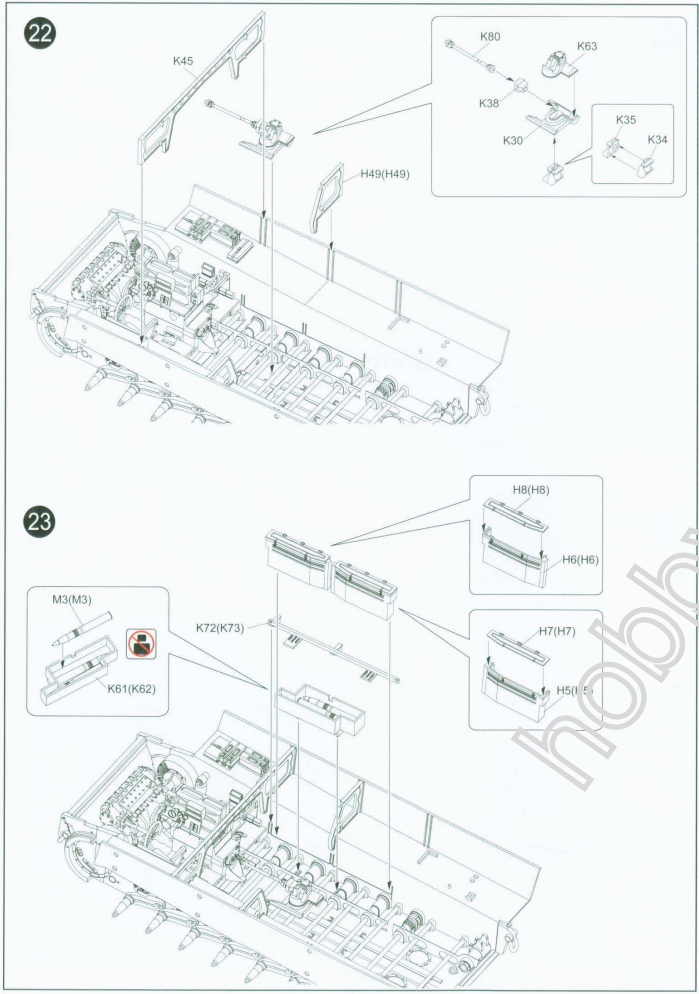

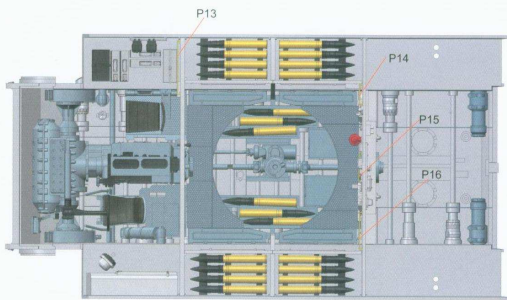

26

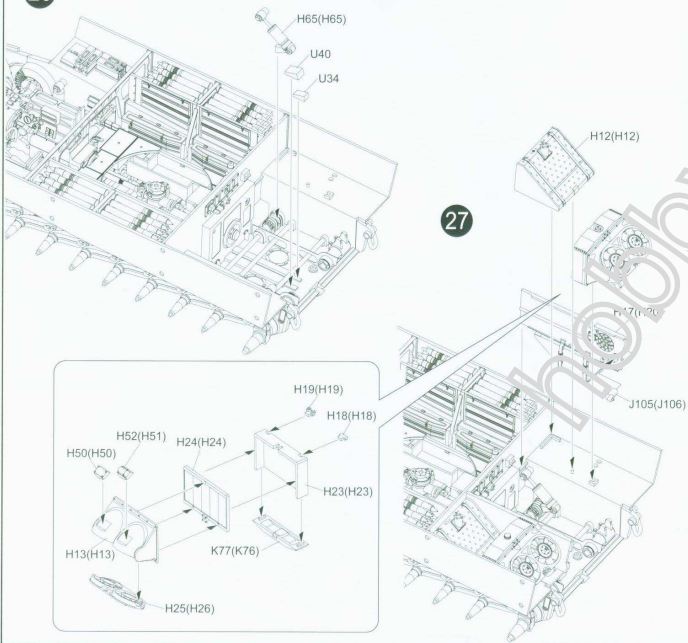

28

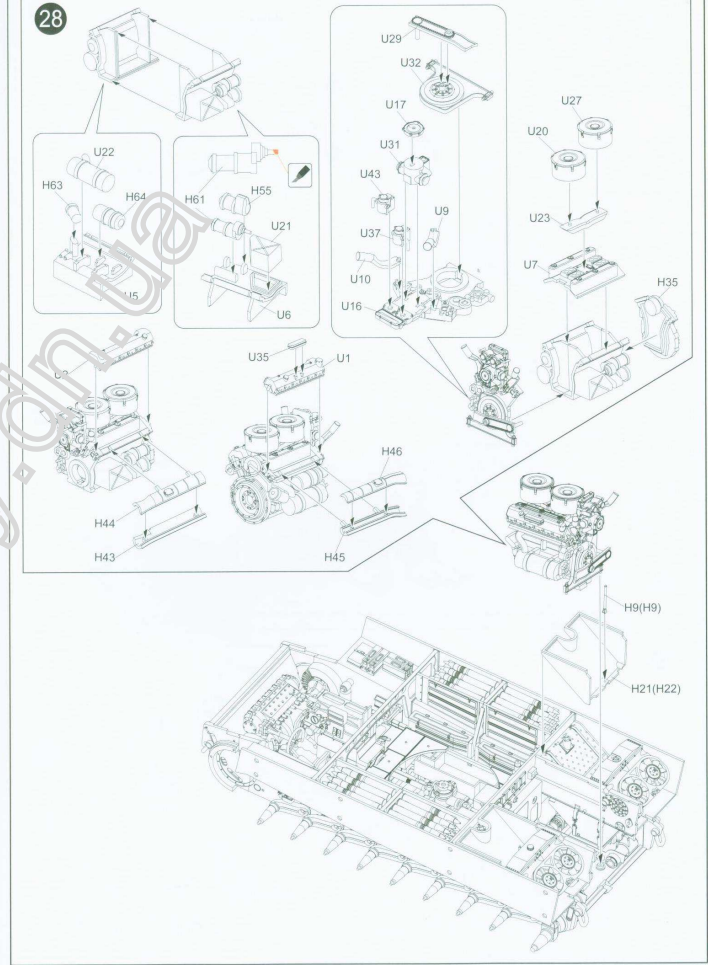

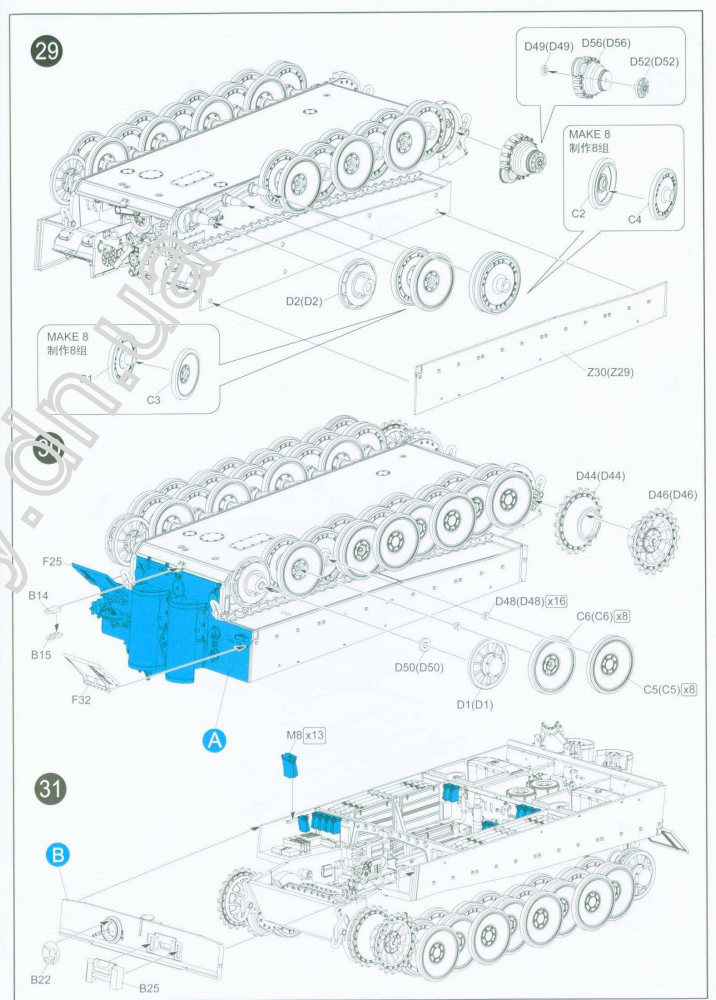
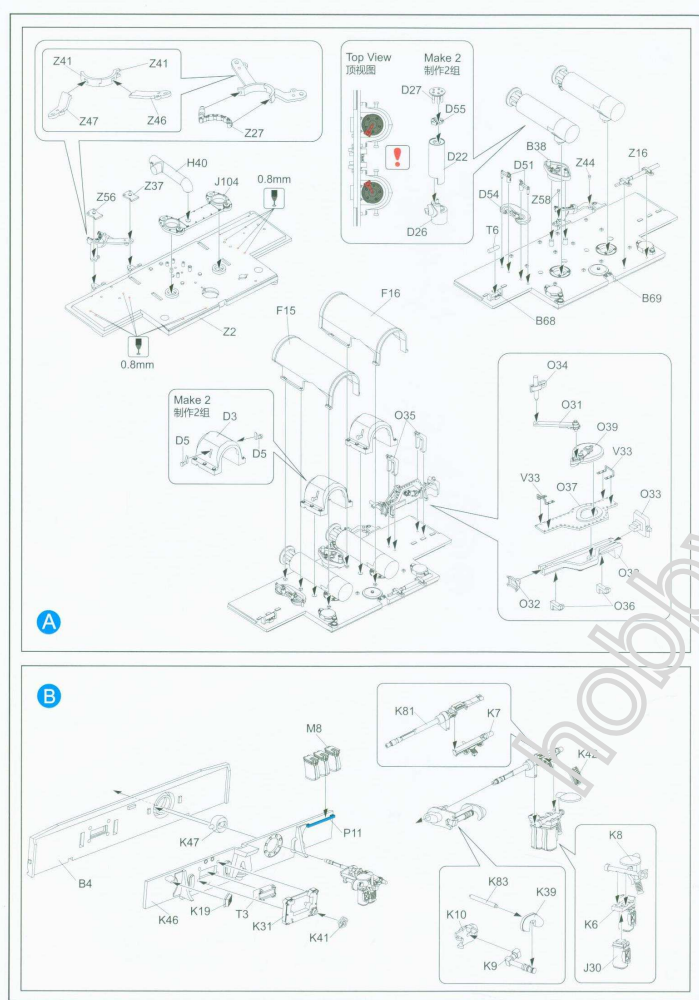

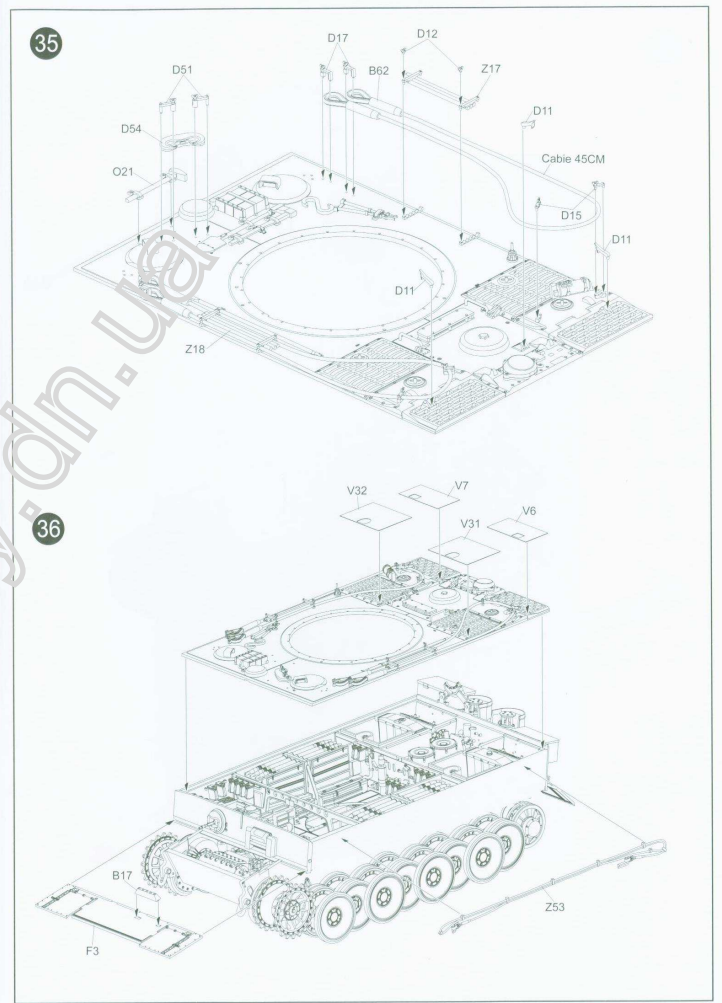
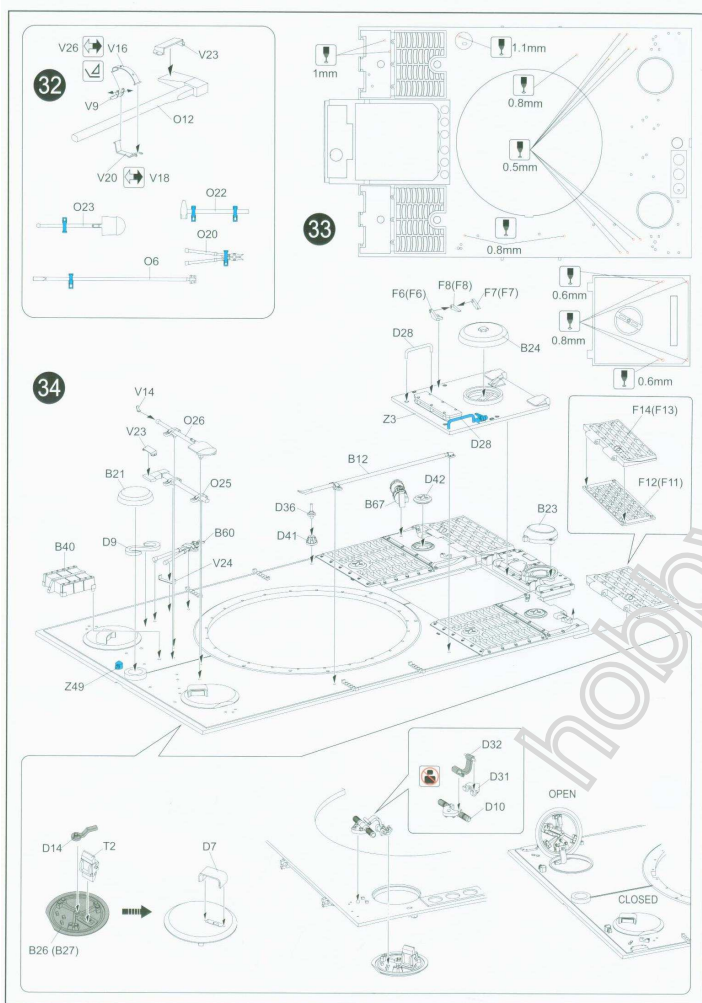

37

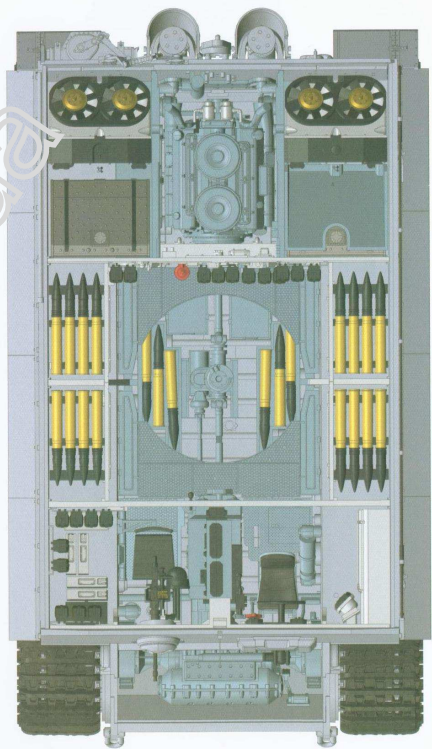
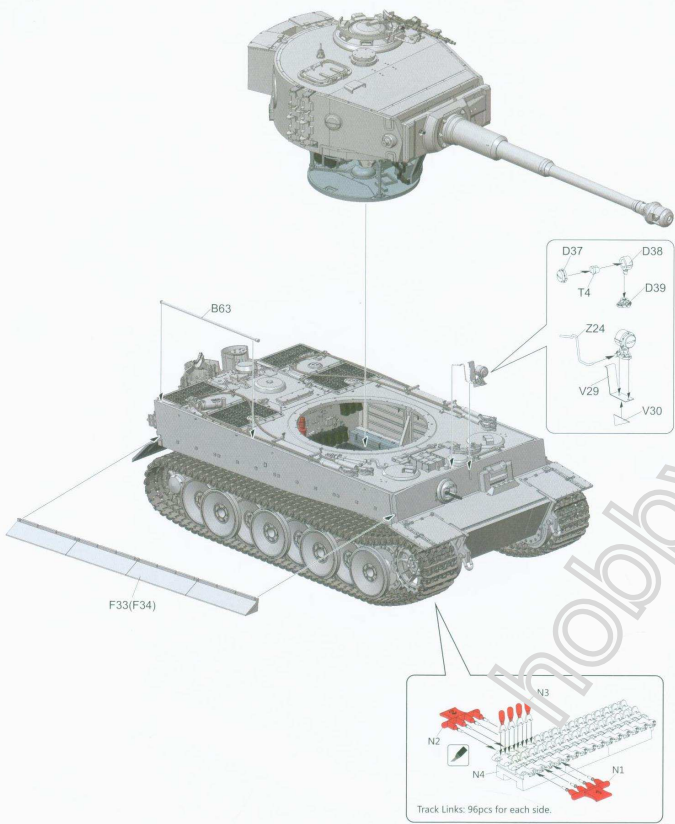

Tiger I Middle Production

1/35 SCALE
RM-5010

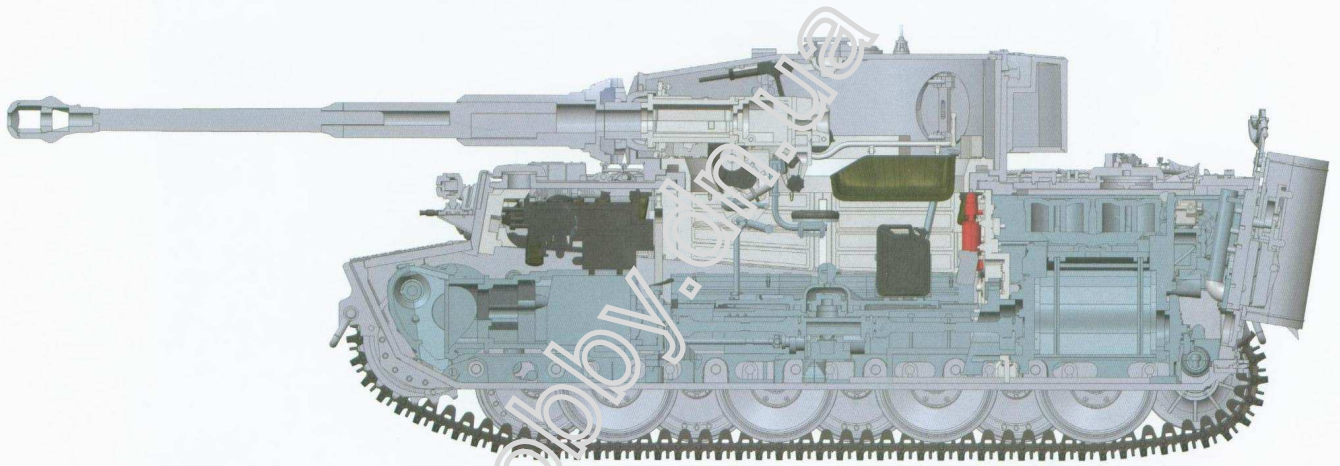

28



RYE FIELD MODEL

E-mail: info@ryefield-model.com

www.ryefield-model.com

Copyright © 2016

