

MONTAŻ

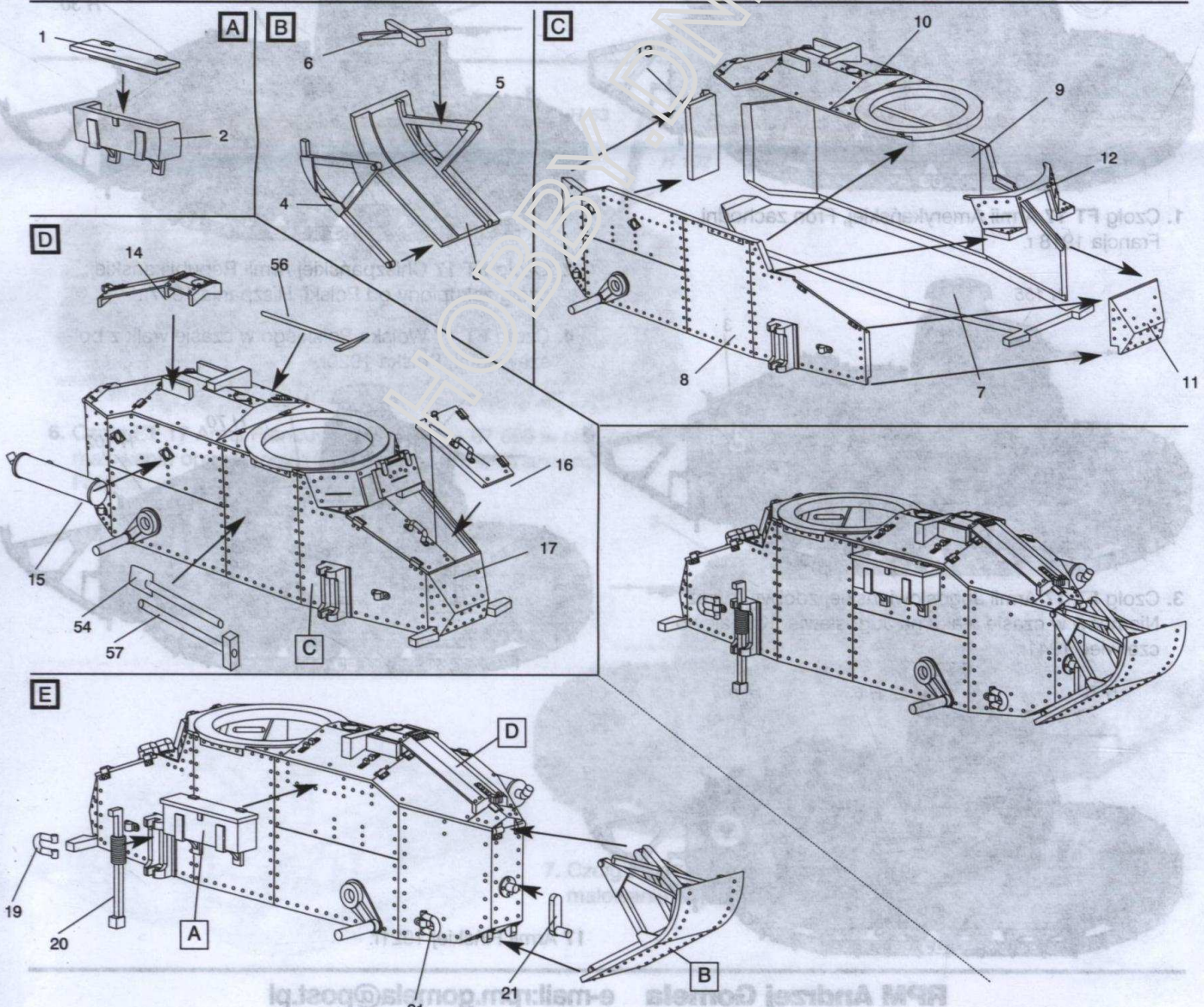

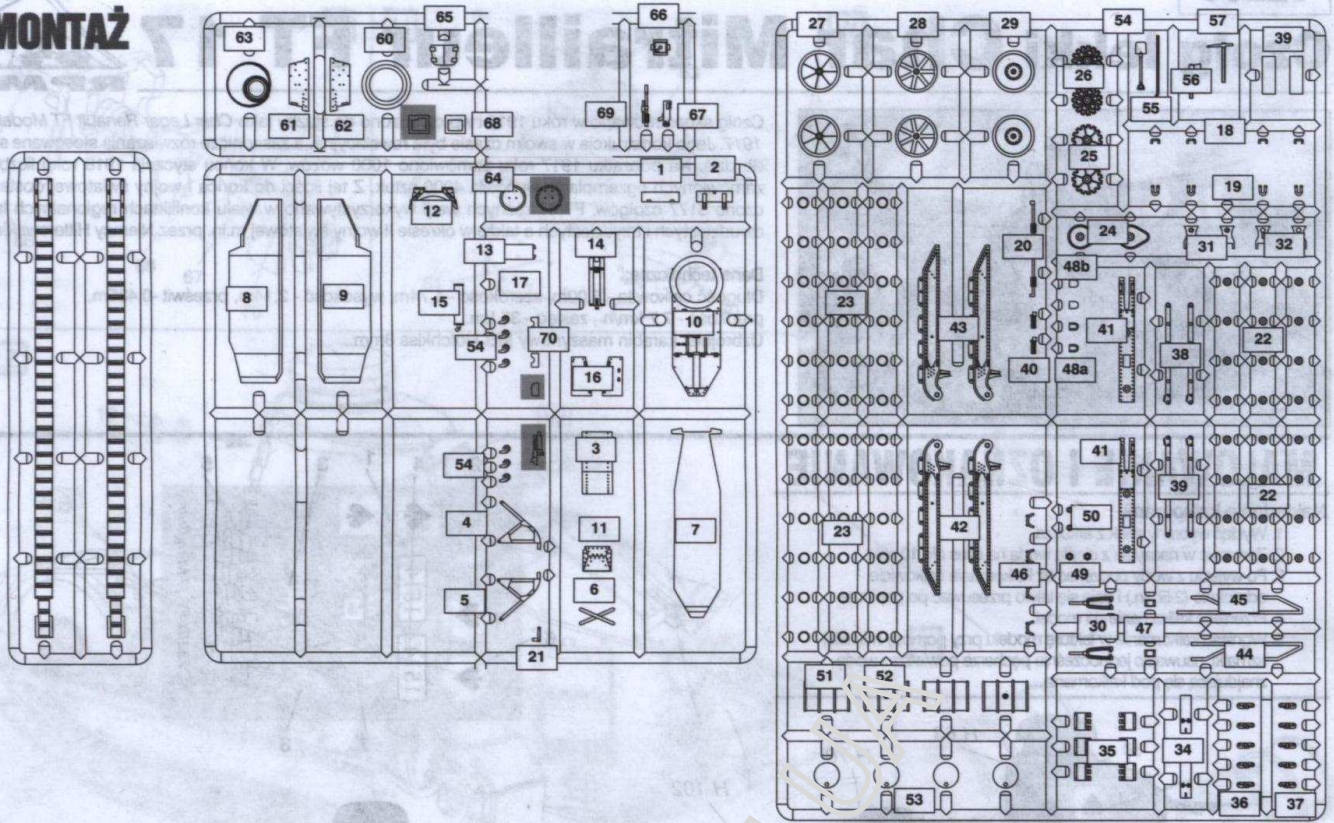

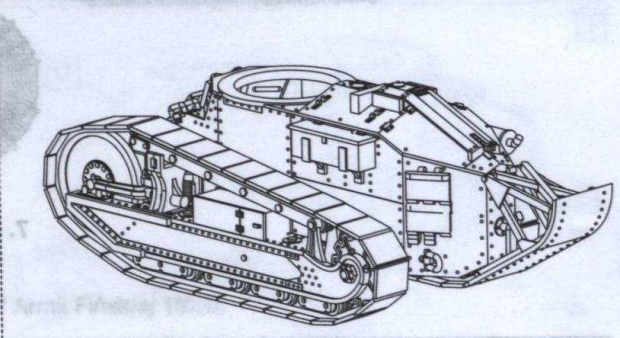
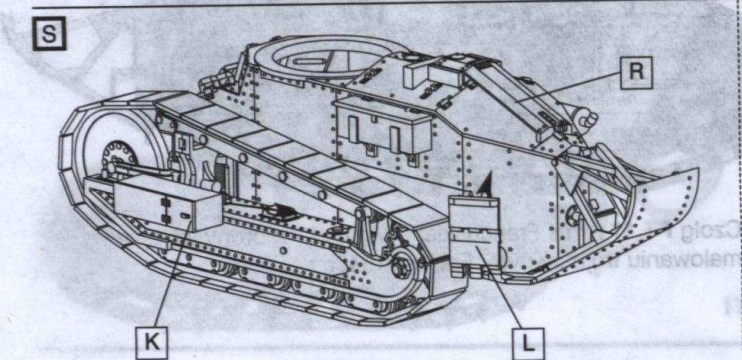
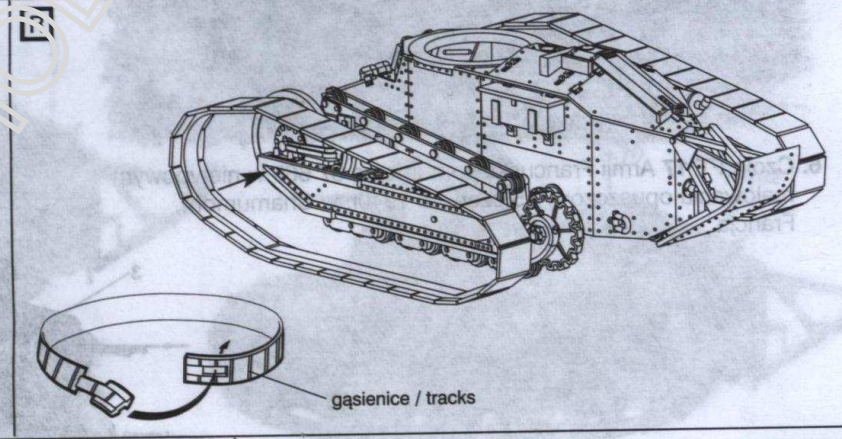
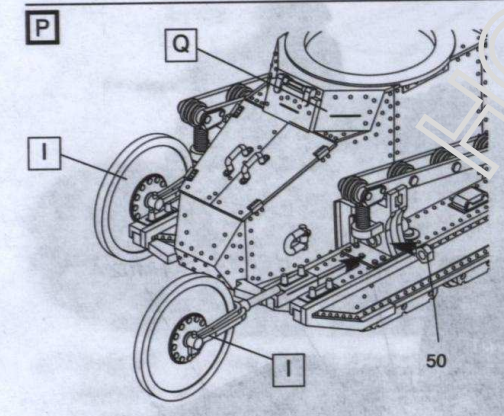
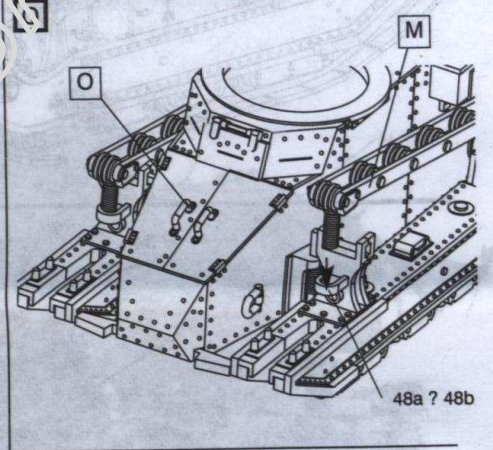
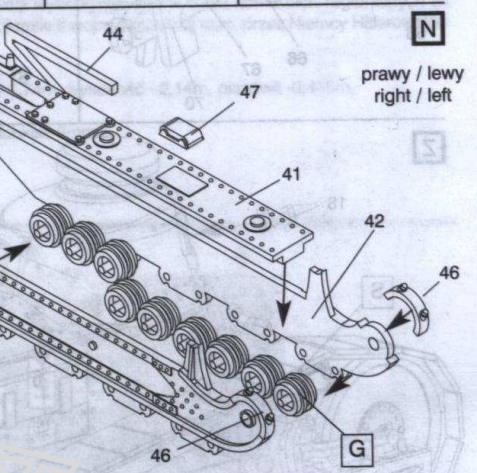
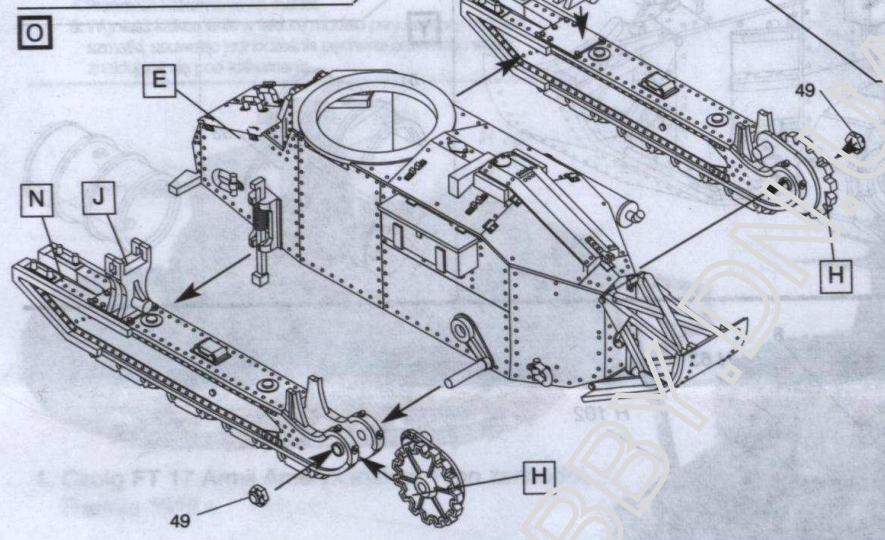
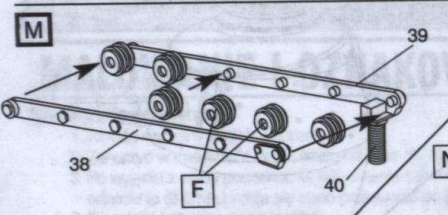
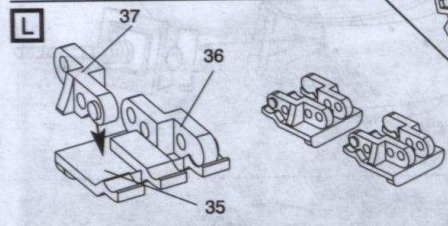
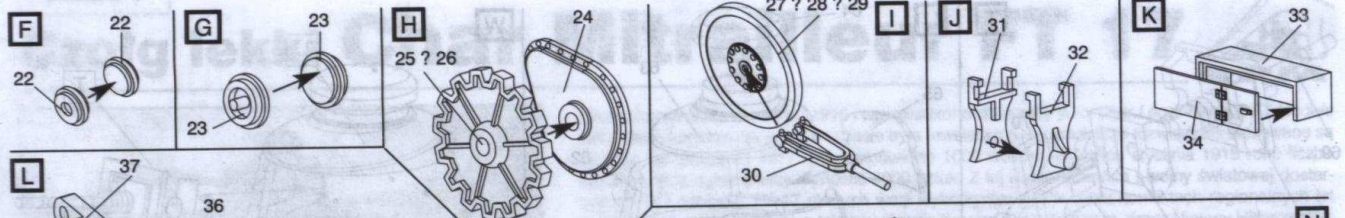
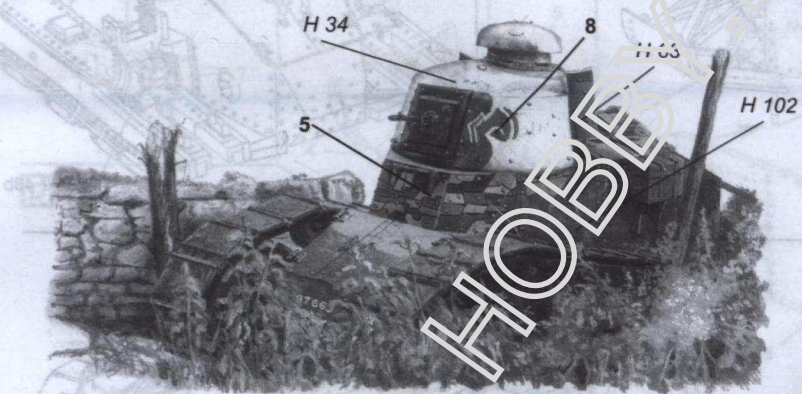
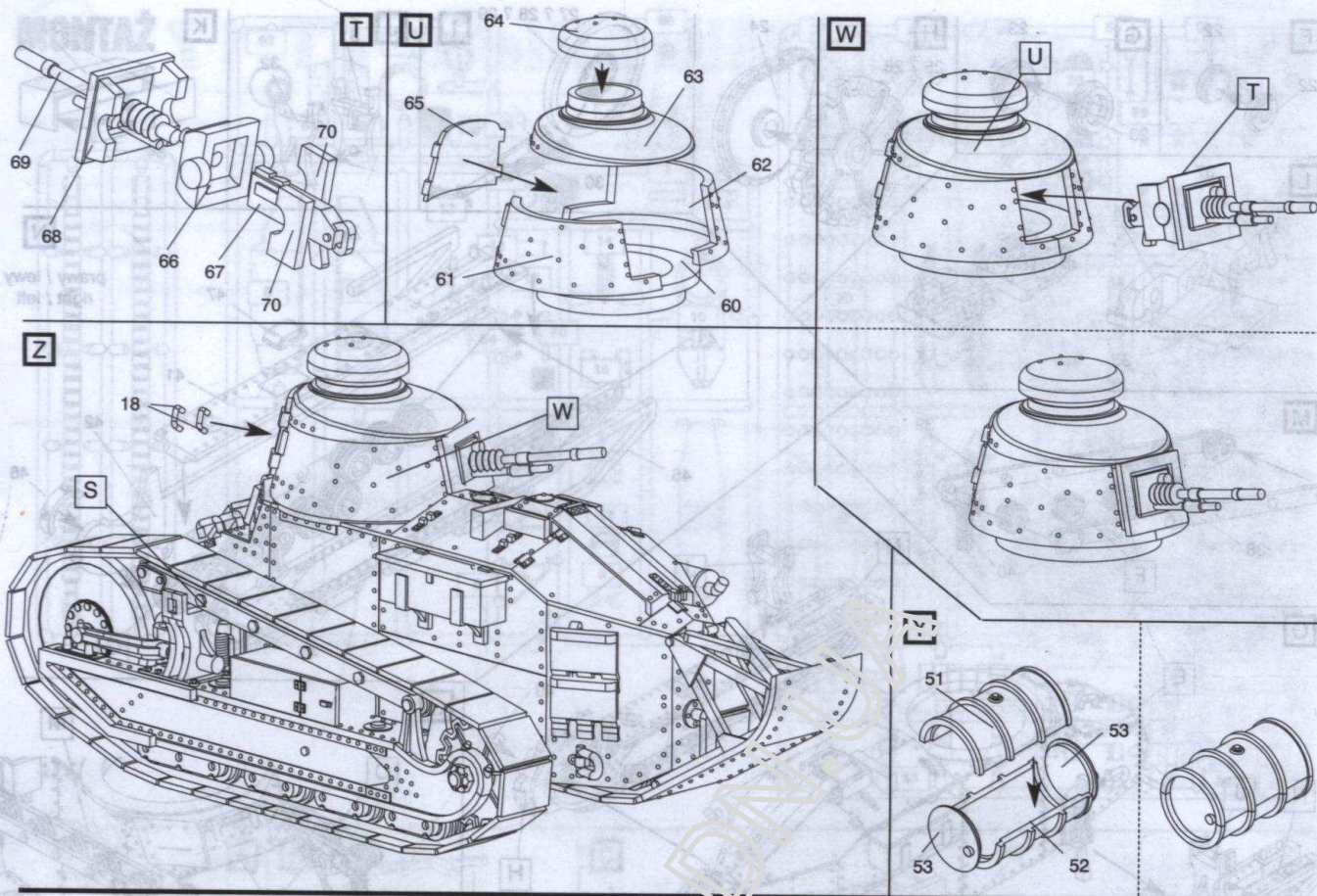

6. Czołg FT 17 Armii Francuskiej o numerze 67 669 w nietypowym malowaniu opuszczony 15 czerwca 1940r. w Chamumont, Francja.

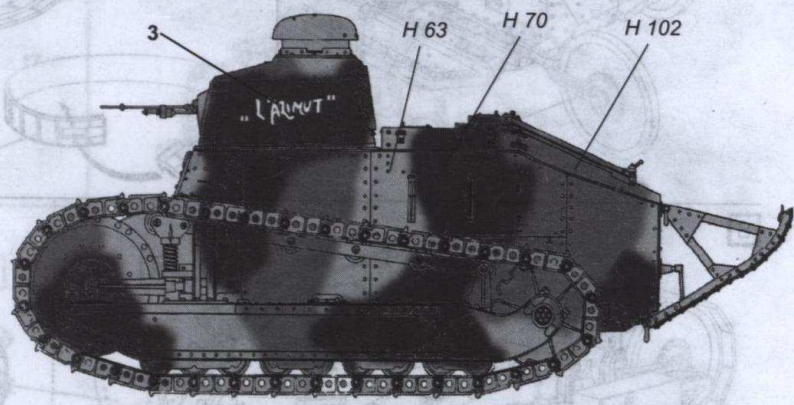

7. Czołg FT 17 Armii Francuskiej „L'Azimut” obrony lotniska w malowaniu trójbarwnym, Francja 1940r.