

SCALE
1:48

RECORD AIRCRAFT
РЕКОРДНИЙ ПИТАК

MESSERSCHMITT
ME.209 V1

A&A MODELS

CAT.NO. 4811

CONTAINS PARTS FOR ONE MODEL:

PLASTIC PARTS -66
2 DIFFERENT DECAL OPTIONS
PAINT MASKS
PHOTO-ETCHED SHEET

ЗБІРНА МОДЕЛЬ \ ЛІМІТОВАНИЙ ВИПУСК
SCALE MODEL KIT \ LIMITED EDITION



УМОВНІ СИМВОЛИ / USED SYMBOLS

- 

1 ЕТАПИ ЗБИРАННЯ
STAGES OF ASSEMBLY
- 

A1 НОМЕР ДЕТАЛІ
PART NUMBER
- 

1 ОКРЕМІ ДЕТАЛІ
SEPARATE DETAILS
- 

1 НАКЛІЇТИ ДЕКАЛІ
APPLY DECALS
- 

1 НАКЛІЇТИ МАСКУ
APPLY THE ADHESIVE MASK
- 

? НА ВИБІР
OPTIONAL
- 

AA СИММЕТРИЧНІ ДЕТАЛІ
SYMMETRIC DETAILS
- 

PS КЛІЇТИ НА СУПЕРКЛЕЙ
GLUE ON "SUPER GLUE"
- 

⊘ НЕ КЛІЇТИ
DON'T GLUE
- 

■ ЗРОБИТИ ОТВІР
MAKE A HOLE
- 

✂ ВІДРІЗАТИ НОЖЕМ
DETACH WITH KNIFE
- 

A ФАРБУВАТИ
TO PAINT

КОМПЛЕКТНІСТЬ / COMPLETE SET

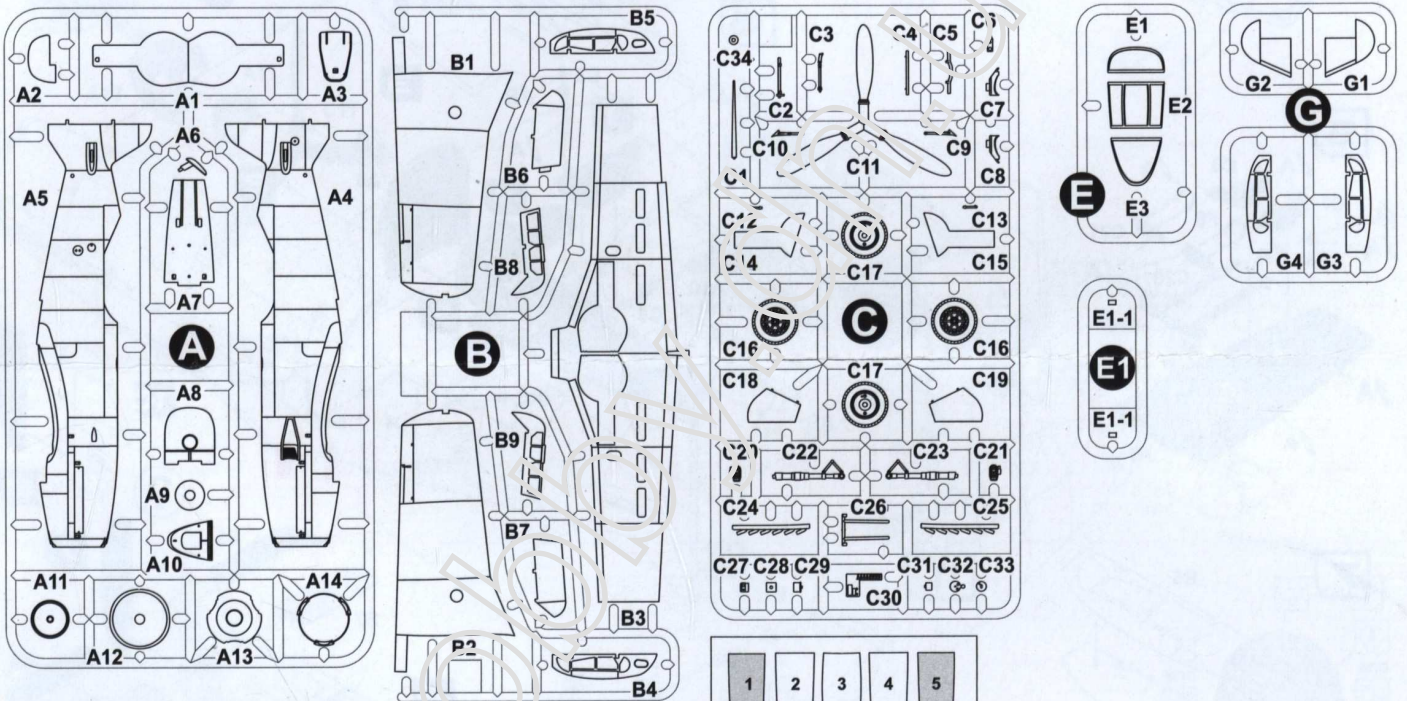

ДЕКАЛЬ / DECAL

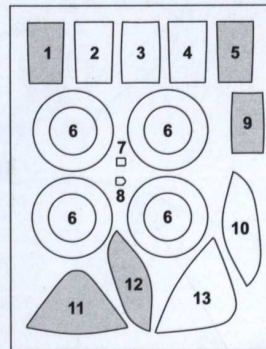
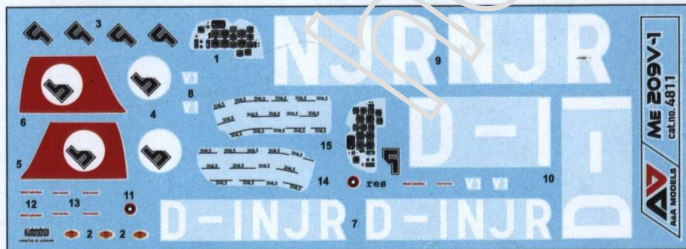

**MASKS
MACKI**

☐ ЗОВНІ
OUTSIDE
■ ВСЕРЕДИНІ
INSIDE

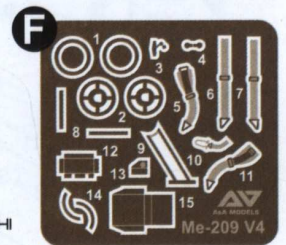

НЕОБХІДНІ ФАРБИ / REQUIRED PAINTS















- | | | | | | | | |
|--|---|--|--|---|--|--|---|
|  <p>A</p> <p>MR.COLOR C60
AK RC265
RLM 02 GRAU</p> |  <p>B</p> <p>MR.COLOR C33
AK RCO01
FLAT BLACK</p> |  <p>C</p> <p>MR.COLOR C61
AK XTR.MET AK484
BURNT IRON</p> |  <p>D</p> <p>MR.MET.COLOR MC218
AK XTR.MET AK479
ALUMINIUM</p> |  <p>E</p> <p>MR.MET.COLOR MC211
AK XTR.MET AK477
CHROM SILVER</p> |  <p>F</p> <p>MR.COLOR C137
AK RCO22
RUBBER BLACK</p> |  <p>G</p> <p>MR.COLOR C113
AK RC267
RLM 04 YELLOW</p> |  <p>H</p> <p>MR.COLOR C62
AK RCO04
RLM 21 WEISS</p> |
|  <p>I</p> <p>MR.COLOR C45
AK RCO46
IVORY</p> |  <p>J</p> <p>MR.COLOR C41
AK RCO67
RED BROWN</p> |  <p>K</p> <p>MR.MET.COLOR MC214
AK XTR.MET AK483
GUN METAL</p> |  <p>L</p> <p>MR.COLOR C114
AK RCO06
RLM23 RED</p> |  <p>M</p> <p>MR.COLOR C18
AK RC274
RLM70 SCHWARZGRUN</p> |  <p>N</p> <p>MR.MET.COLOR MC213
AK XTR.MET AK476
STEEL</p> |  <p>P</p> <p>85% 15%
MR.COLOR C65+C2
AK RCO11
BLUE</p> | |

СХЕМА ЗБИРАННЯ / SCHEME OF ASSEMBLY



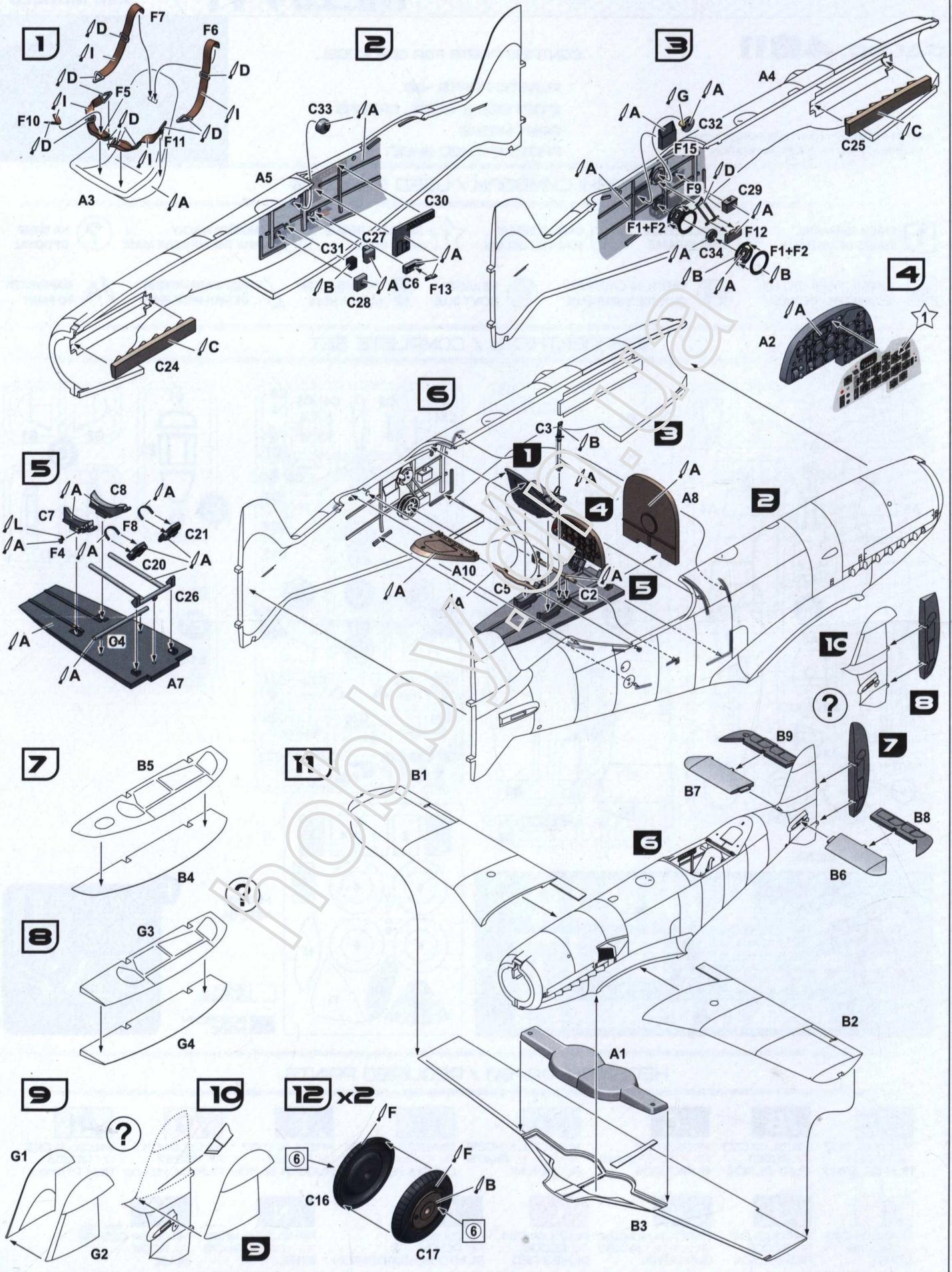

СХЕМА ЗАБАРВВЕНИЯ / THE SCHEME OF COLOURING

1. Me.209 V-1, D-INJR, on 26 April 1939, pilot Fritz Wendel flying this machine, achieved a new world speed record of 755.14 km/h



2. Me.209 V-1, D-INJR, with the original tail fin, pilot Dr.-Ing. Hermann Wurster. In the early stage of flight tests, the plane remained in its natural metal finish and flew without the undercarriage cover panels.

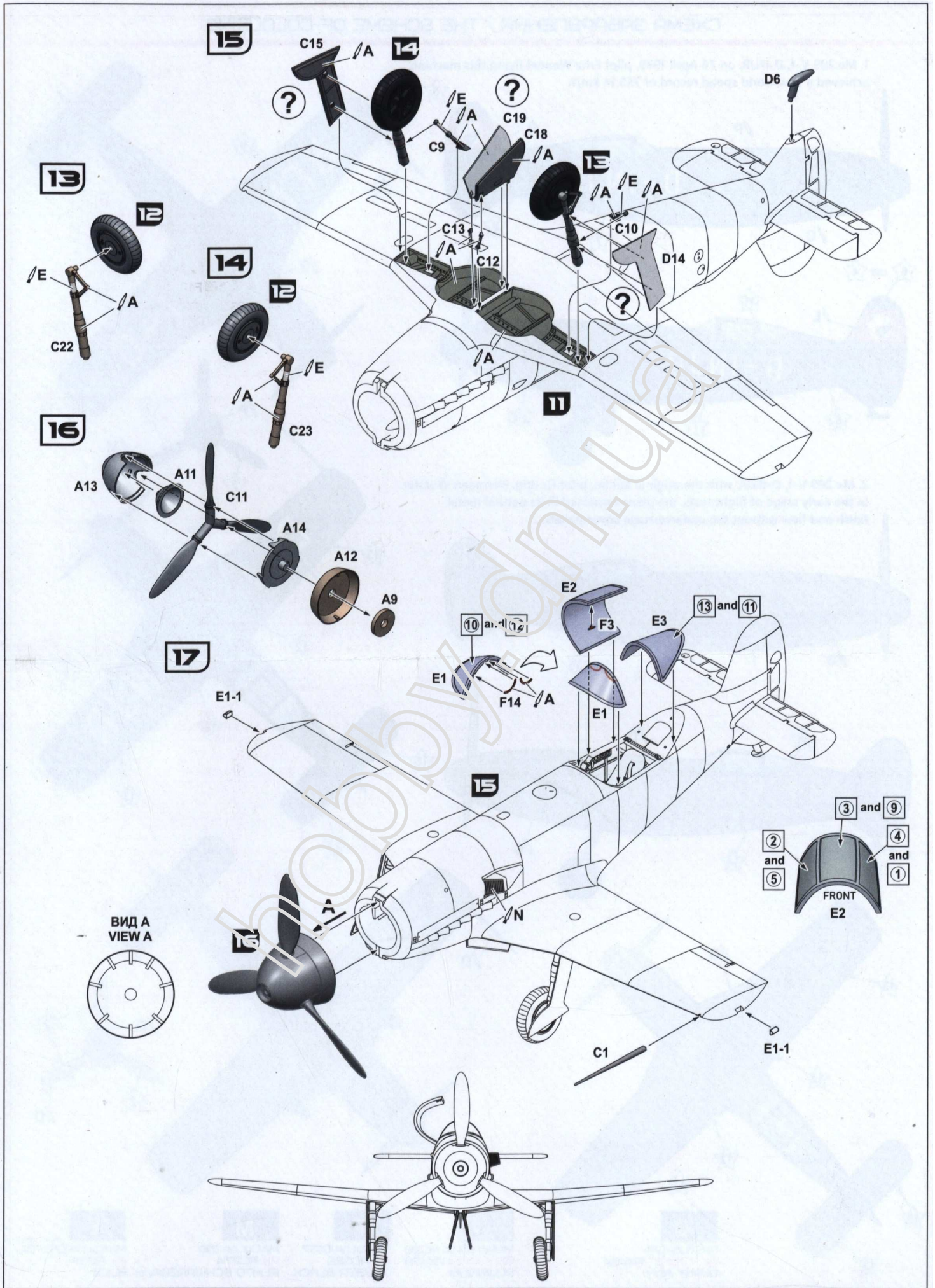
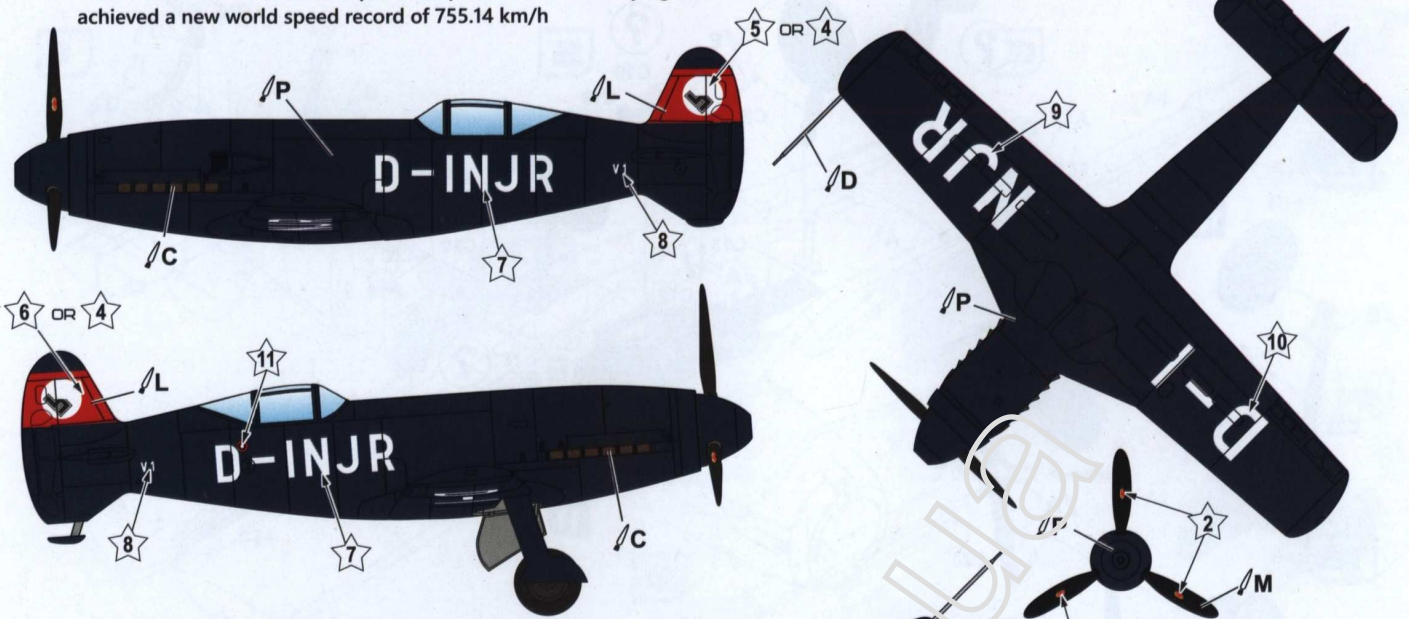
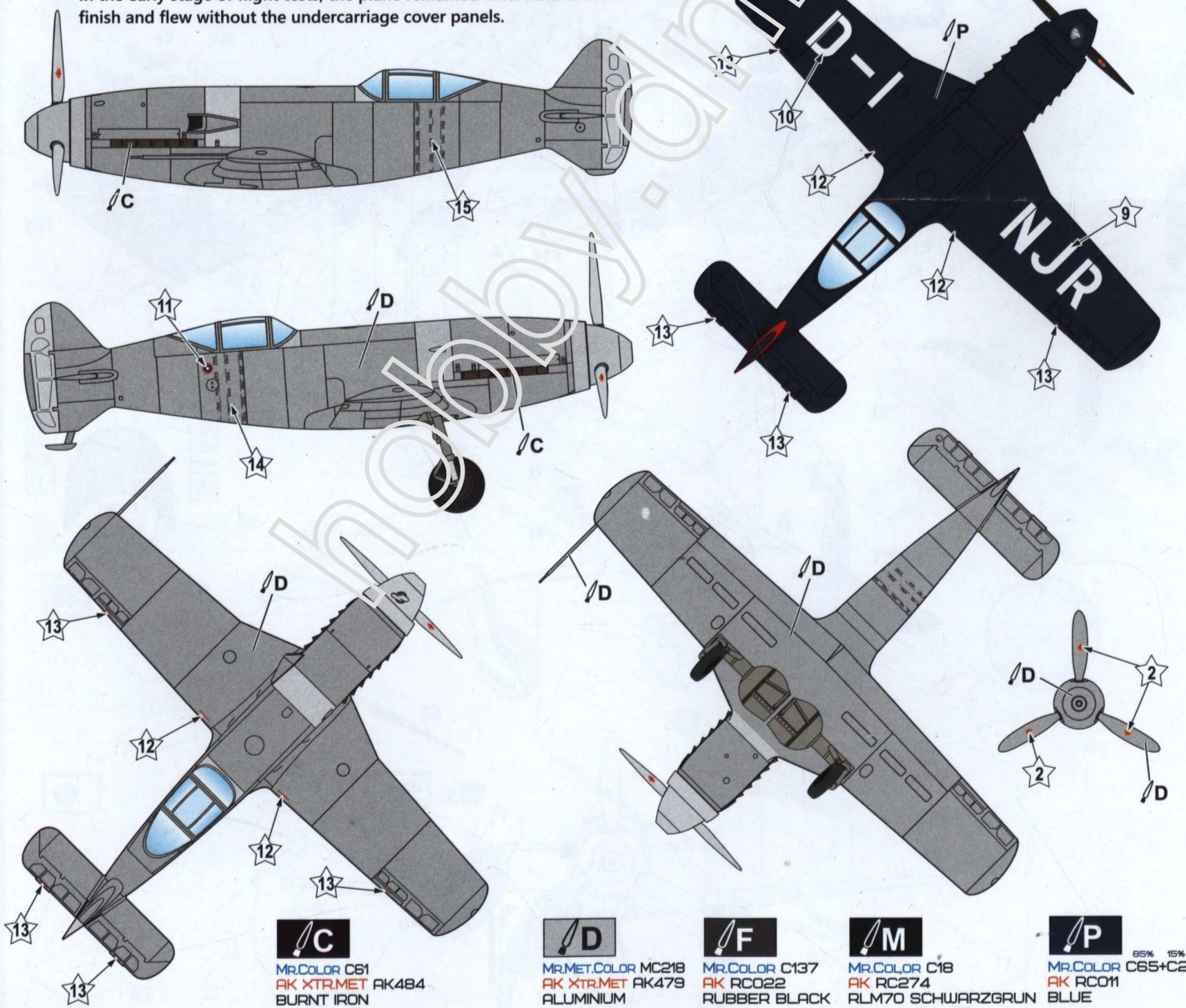

MR.COLOR C61
AK XTRMET AK484
BURNT IRON



MR.MET.COLOR MC218
AK XTRMET AK479
ALUMINIUM



MR.COLOR C137
AK RC022
RUBBER BLACK



MR.COLOR C18
AK RC274
RLM70 SCHWARZGRÜN



85% 15%
MR.COLOR C65+C2
AK RC011
BLUE