

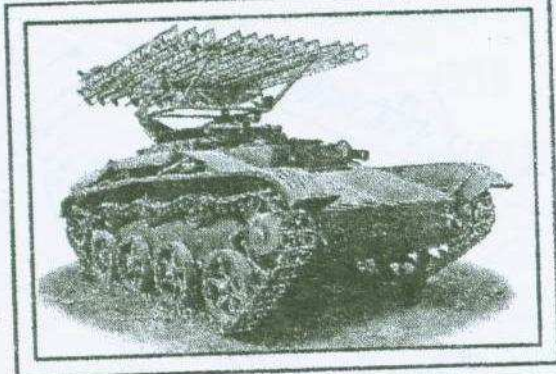

BM-8-24

(Katiusha MLRS on T-60 chassis)

1/72 scale
Plastic model kit.
cat. #72542



Parts.

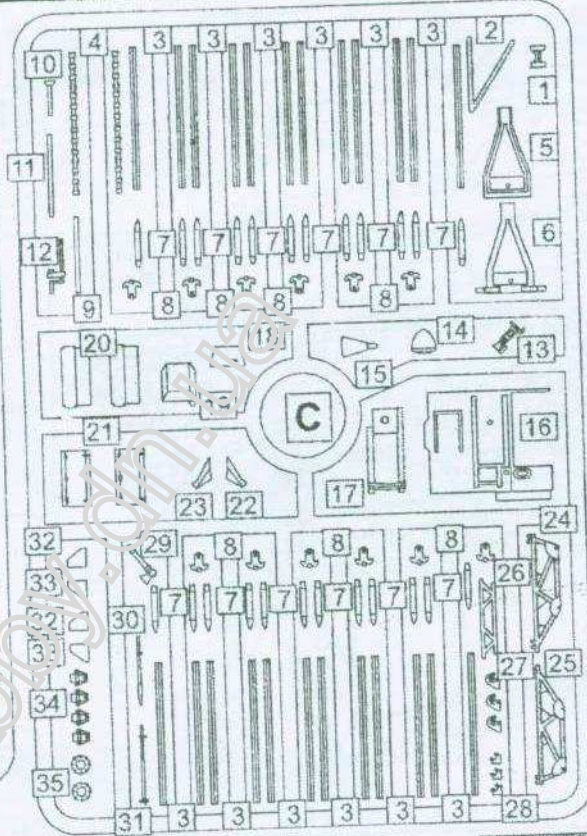
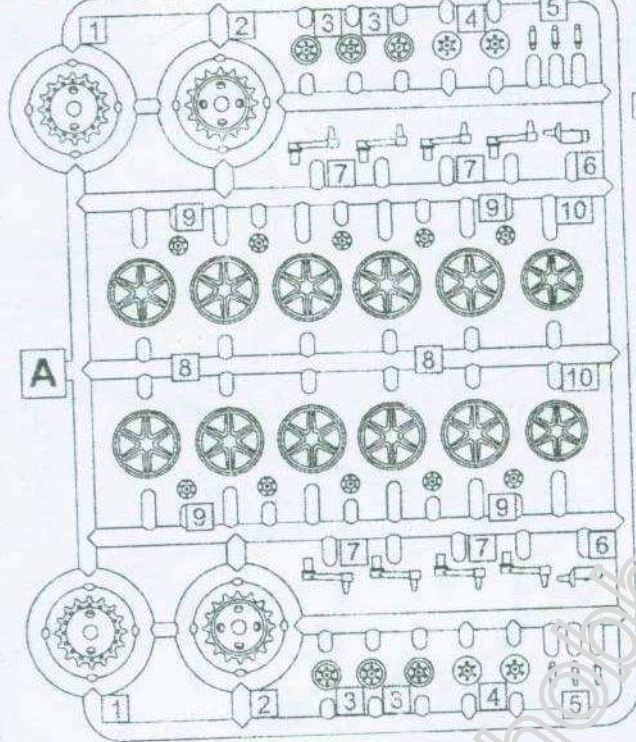

Rubber tracks (R)



Etched parts (E)

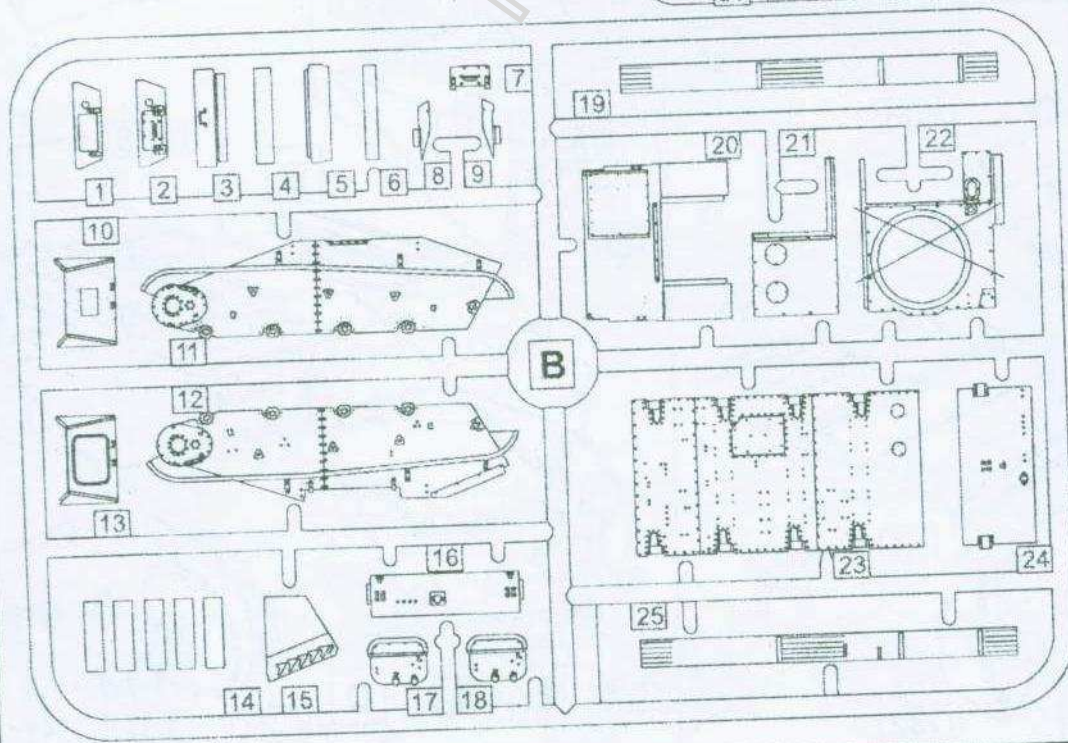
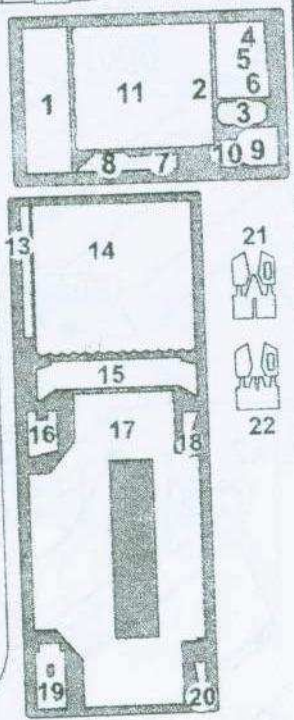

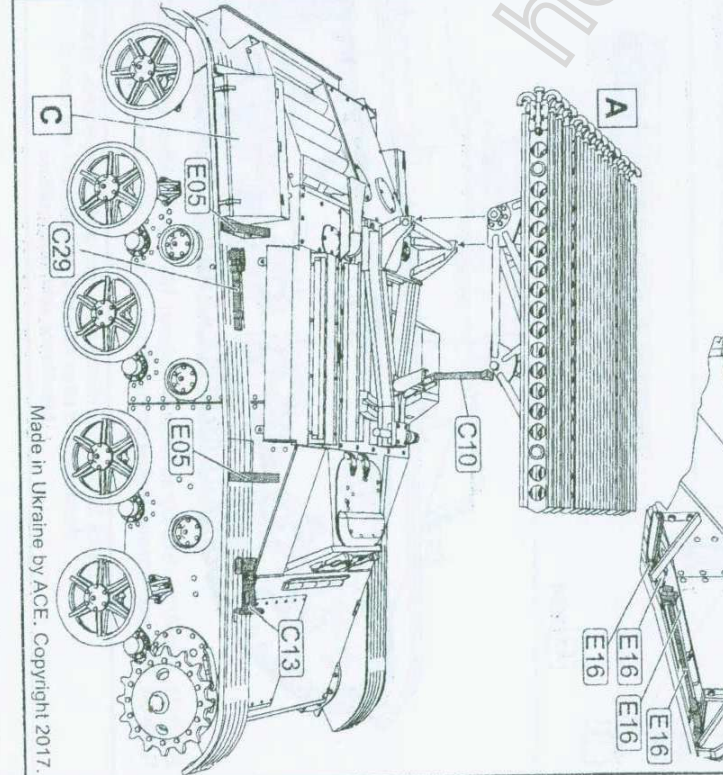
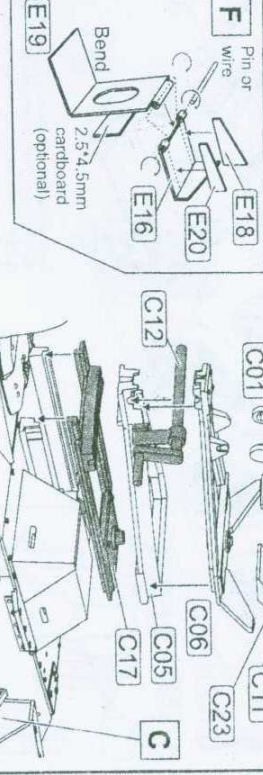
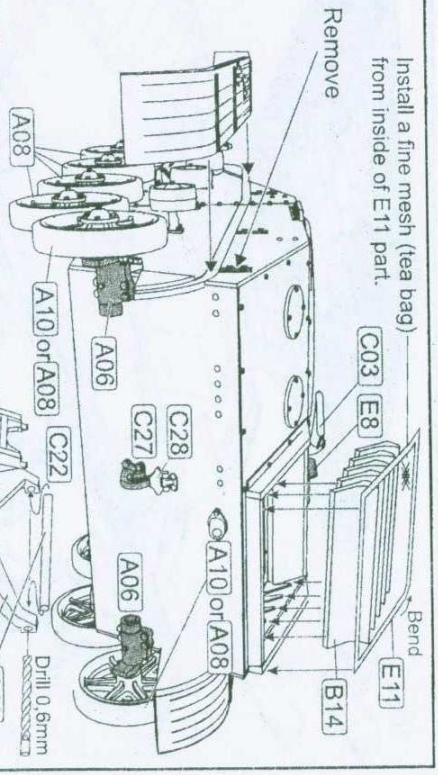
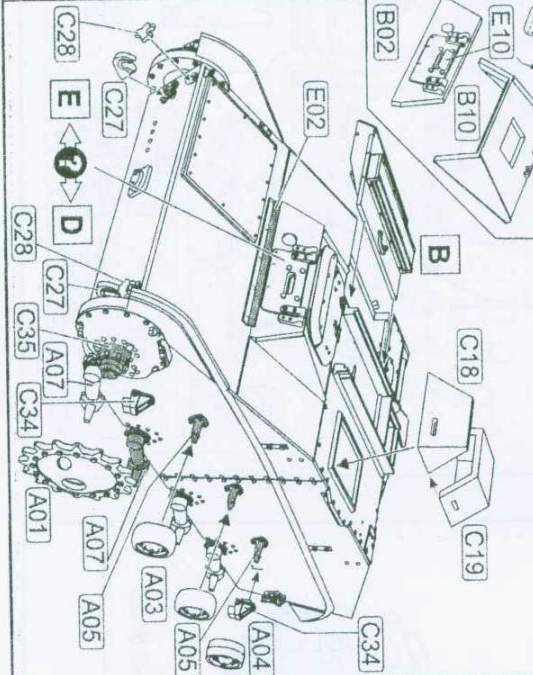
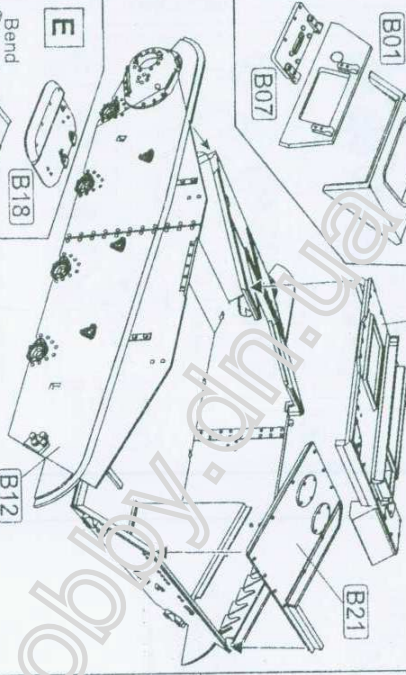
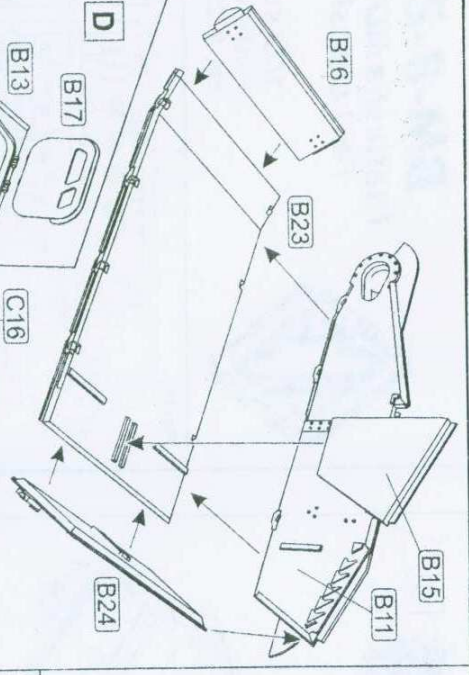
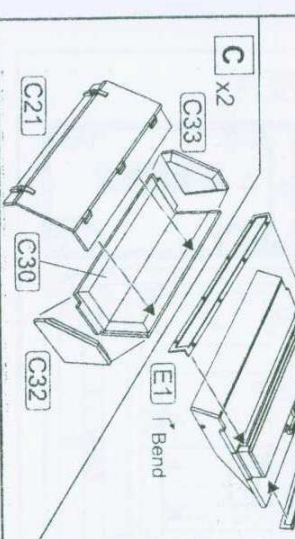
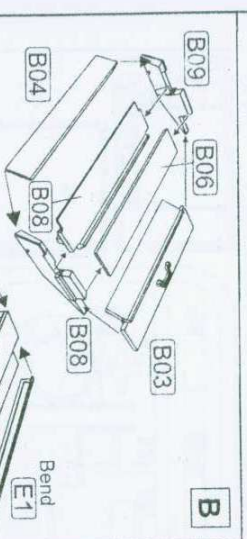
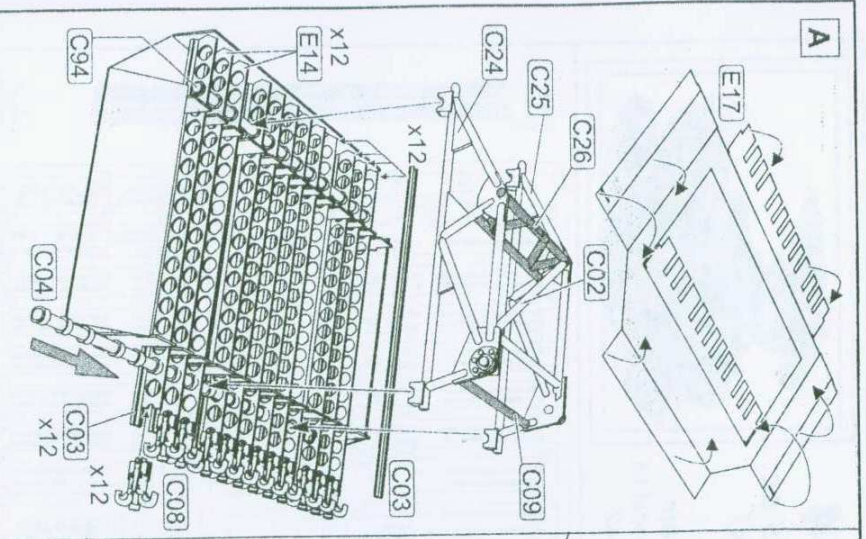

Install a fine mesh (tea bag) from inside of E11 part.

Remove

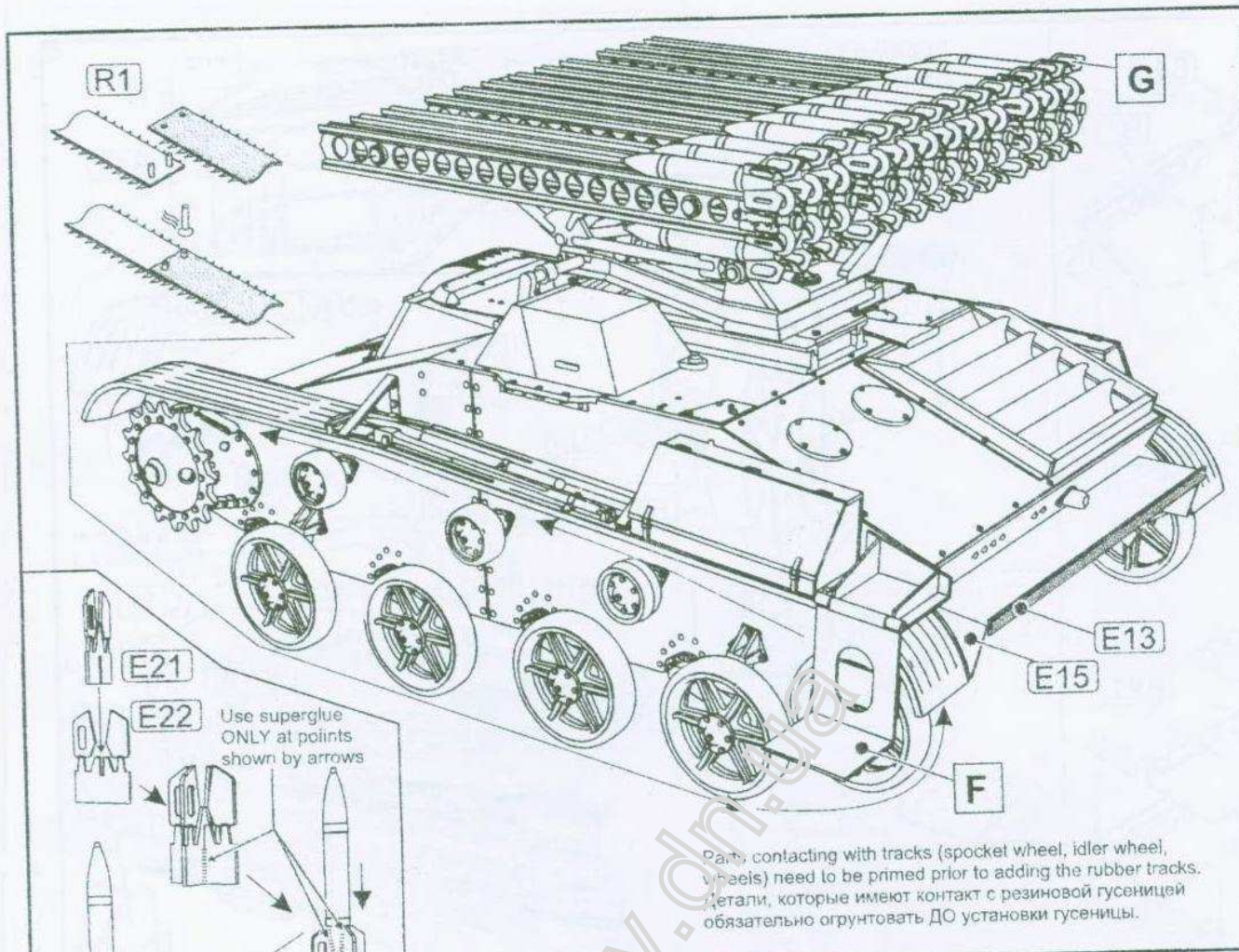

Parts contacting with tracks (spocket wheel, idler wheel, wheels) need to be primed prior to adding the rubber tracks.
 Части, которые имеют контакт с резиновой гусеницей обязательно грунтуют ДО установки гусеницы.

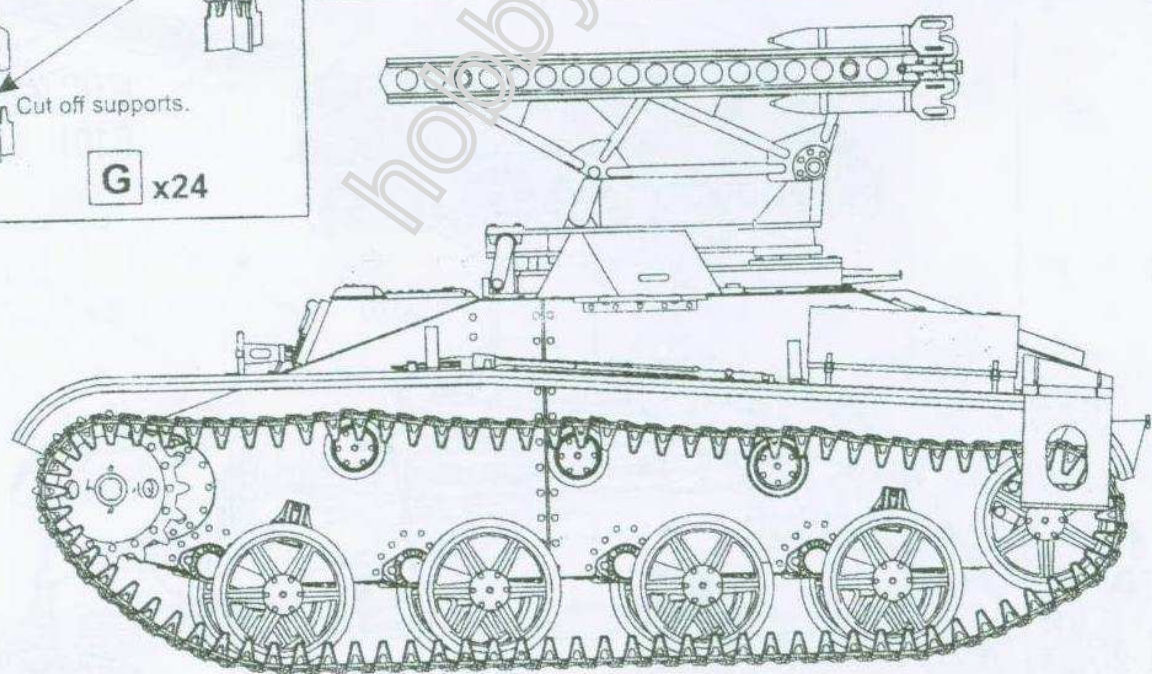

BM-8-24. Red Army. Stalingrad Region. Autumn 1942. Soviet khaki Green (4BO).
 BM-8-24. Красной армии. Район сталинграда. Осень 1942г. Защитный зелёный (4BO).

Check for historical photos of this gun and other vehicles, detailed descriptions of other ACE kits, new products and more at:
<http://www.acemodel.com.ua>