

PLASTIC MODEL KITS
LIMITED EDITION
CAT.NO. 1440



SPAN : 126 mm
LENGTH : 90 mm
PARTS : 92 pieces

SCALE: 1/144

 The AN-3T aircraft is the further modification of the well-known AN-2 aircraft that has been in operation all over the world for 50 years. More than 15500 of the AN-2 aircraft have been totally produced by the plants of the former USSR, Poland and China.





 Самолет Ан-3 является дальнейшим развитием широко известного самолета Ан-2, эксплуатирующегося во многих странах мира на протяжении 50 лет. Всего заводами в СССР, Польше и Китае было выпущено более 15500 самолетов Ан-2.

The model is executed on technology short run and is intended only for experienced modelers
Word-wide distributor for AMODEL kits : IBG, Warszawa, Poland
Fax: (4822) 842-56-29 ; E-Mail: ibgsc@ibg.com.pl

Модель выполнена по технологии short run и предназначена только для опытных моделистов
Дистрибьютор моделей AMODEL : IBG, Варшава, Польша
Факс: (4822) 842-56-29 ; E-Mail: ibgsc@ibg.com.pl



USED SYMBOLS / ИСПОЛЬЗУЕМЫЕ СИМВОЛЫ

- | | | | | |
|--|--|--|---|--|
| 1 STAGES OF ASSEMBLY
ЭТАПЫ СБОРКИ | 1A NUMBER PARTS
НОМЕР ДЕТАЛИ | 1 APPLY DECALS
НАНЕСТИ ДЕКАЛЬ | A! TO PAINT
ОКРАСИТЬ |  GLUE
КЛЕИТЬ ↓ |
|  DONT GLUE
НЕ КЛЕИТЬ ↓ | ? OPTIONAL
НА ВЫБОР |  MAKE A HOLE
ВЫПОЛНИТЬ ОТВЕРСТИЕ |  DETACH WITH KNIFE
ОТДЕЛИТЬ НОЖИМ | 2x QUANTITY OF OPERATIONS(PARTS)
КОЛИЧЕСТВО ОПЕРАЦИЙ(ДЕТАЛЕЙ) |



USED PAINTS / ИСПОЛЬЗУЕМЫЕ КРАСКИ

- | | | | | |
|---|--|---|--|---|
| A! 
HUMBROL 34
WHITE
БЕЛЫЙ | B! 
HUMBROL 33
BLACK
ЧЕРНЫЙ | C! 
HUMBROL 24
YELLOW
ЖЕЛТЫЙ | D! 
HUMBROL 18
ORANGE
ОРАНЖЕВЫЙ | E! 
HUMBROL 19
RED
КРАСНЫЙ |
| F! 
HUMBROL 166
LIGHT AIRCRAFT
GREY
СВЕТЛО-СЕРЫЙ | G! 
HUMBROL 87
STEEL GREY
СТАЛЬН. СЕРЫЙ | | | |

DECALS FOR TWO VERSIONS OF COLOURING
 ДЕКАЛЬ ДЛЯ ДВУХ ВАРИАНТОВ ОКРАСКИ

73 DETAILS FOR ASSEMBLY OF ONE MODEL
 73 ДЕТАЛЕЙ ДЛЯ СБОРКИ ОДНОЙ МОДЕЛИ

PARTS NOT FOR USE
 ПРИ СБОРКЕ НЕ ИСПОЛЬЗУЮТСЯ

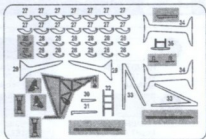
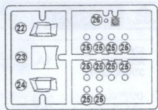
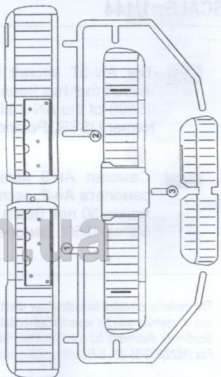
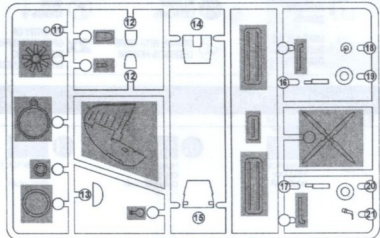
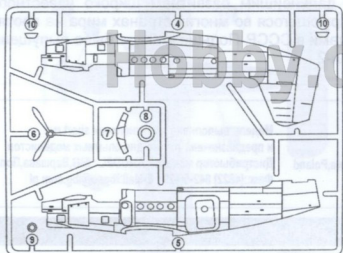
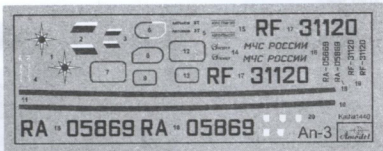



1  12 x 2 13 14 15

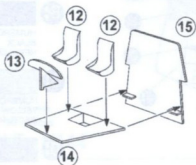

2  22 23 24

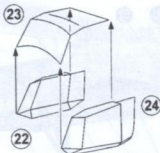

3  4 25 x 5 26

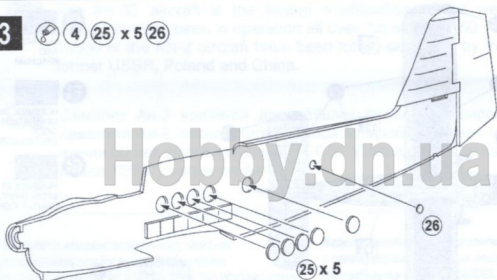

4  5 25 x 6

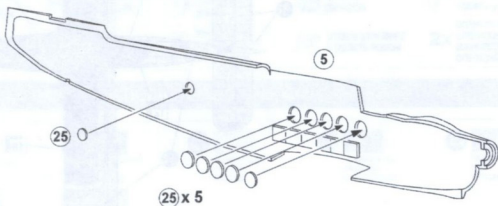

5  1 2 3 4 6 8 9 11

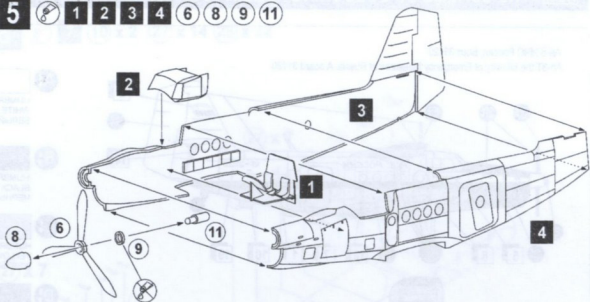

6  5 1 2 3 7 29 x 2 34 x 2

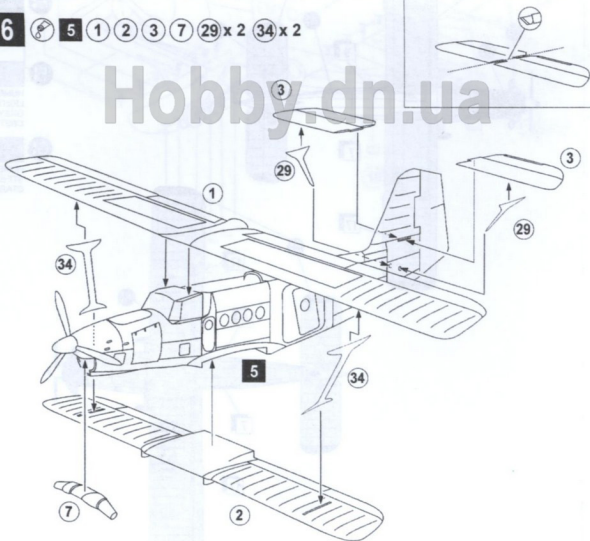

7



6

16

17

18

19

20

21

30

31

33 x 2

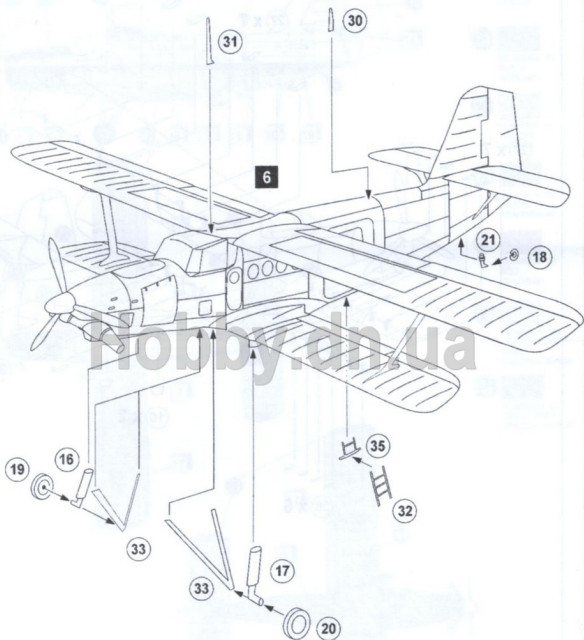

8



7

10 x 2

27 x 14

28 x 12

27 x 7

27 x 7

7

28 x 6

10 x 2

28 x 6

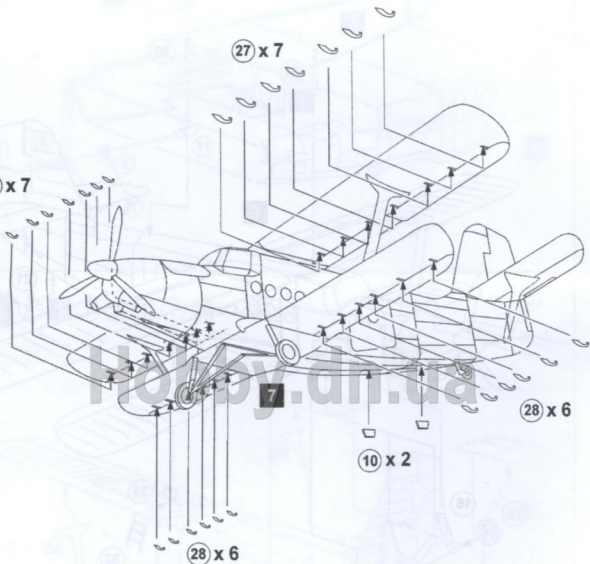



THE SCHEME OF COLOURING / СХЕМА ОКРАСКИ

Ан-3 МЧС России. Борт 31120

An-3T the Ministry of Emergency Measures of Russia. A board 31120

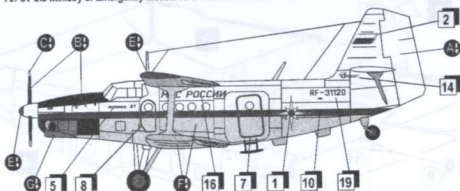

A: 
HUMBROL 34
WHITE
БЕЛЫЙ

B: 
HUMBROL 33
BLACK
ЧЕРНЫЙ

C: 
HUMBROL 24
YELLOW
ЖЕЛТЫЙ

D: 
HUMBROL 18
ORANGE
ОРАНЖЕВЫЙ

E: 
HUMBROL 19
RED
КРАСНЫЙ

F: 
HUMBROL 166
LIGHT AIRCRAFT
GREY
СВЕТЛО-СЕРЫЙ

G: 
HUMBROL 87
STEEL GREY
СТАЛЬН. СЕРЫЙ

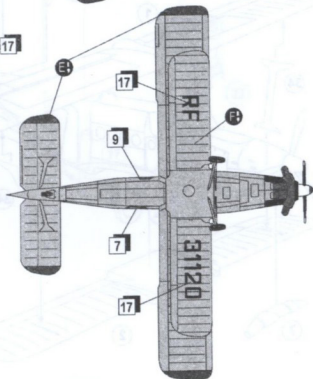
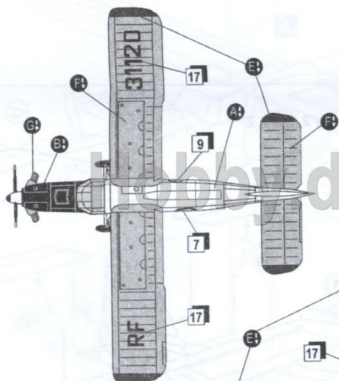

Ан-3Т Аэропорт Ачинск - Россия. Борг 05869.
 An-3T City airport of Achinsk Russia. A board 05869

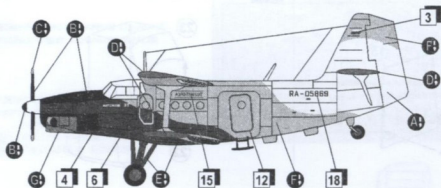

A:  HUMBROL 34
 WHITE
 БЕЛЫЙ

B:  HUMBROL 33
 BLACK
 ЧЕРНЫЙ

C:  HUMBROL 24
 YELLOW
 ЖЕЛТЫЙ

D:  HUMBROL 18
 ORANGE
 ОРАНЖЕВЫЙ

E:  HUMBROL 19
 RED
 КРАСНЫЙ

F:  HUMBROL 166
 LIGHT AIRCRAFT
 GREY
 СВЕТО-СЕРЫЙ

G:  HUMBROL 67
 STEEL GREY
 СТАЛЬН. СЕРЫЙ

