



PLASTIC MODEL KITS
LIMITED EDITION
CAT.NO.72172



WIDTH : 115 mm
LENGTH : 456 mm
PARTS : 292 pieces
SCALE:1/72

 The Mi-10 helicopter was designed by the Mil Aviation Company in 1960. The Mi-10 made its maiden flight on 15th June 1960 by the leading test pilot of the R.I. Kapreyan Company. It successfully passed the test program. After the fourth flight the Mi-10 made the flight with range of 3000 km, which was successfully finished with some refueling landings. On 9th July 1961 the helicopter was public demonstrated for the first time on the air pageant in honor of the USSR Air Fleet Day. The absolute world capacity record was set by the Zemskov crew on 23th September 1961. The weight of 15103 kg was lifted on the altitude of 2200 m. After the helicopter successfully passed the test program, the serial production began.

 Вертолет Ми-10 конструкции ОКБ Миль был построен в 1960 году. 15 июня 1960 года Ми-10 впервые поднялся в воздух под управлением ведущего летчика-испытателя фирмы Р.И. Капреяна. Испытания проводились успешно. Уже в четвертом полете Ми-10 отправился в перелет протяженностью 3000 км, который благополучно завершил, выполнив несколько посадок для дозаправки. 9 июля 1961 года машину впервые продемонстрировали публично на воздушном параде в честь Дня Воздушного Флота СССР. Экипаж Земсков 23 сентября 1961 года установил абсолютный мировой рекорд грузоподъемности, подняв 15103 кг на высоту 2200 м. Вертолет успешно прошел весь комплекс испытаний и был принят в производство.

The model is executed on technology short run and is intended only for experienced modellers
World-wide distributor for AMODEL kits : IBG, Warszawa, Poland
Fax:(4822)842-56-29 ; E-Mail:ibgsc@ibg.com.pl

Модель выполнена по технологии short run и предназначена только для опытных моделлеров
Дистрибутор моделей AMODEL : IBG, Варшава, Польша
Факс:(4822) 842-56-29 ; E-Mail:ibgsc@ibg.com.pl



USED SYMBOLS / ИСПОЛЬЗУЕМЫЕ СИМВОЛЫ

1 STAGES OF ASSEMBLY
ЭТАПЫ СБОРКИ

1 NUMBER PARTS
НОМЕР ДЕТАЛИ

1 APPLY DECALS
НАНЕСТИ ДЕКАЛИ

A TO PAINT
ОКРАСИТЬ

1 GLUE
КЛЕИТЬ

X DON'T GLUE
НЕ КЛЕИТЬ

? OPTIONAL
НА ВЫБОР

1 MAKE A HOLE
ВЫПОДНИТЬ ОТВЕРСТИЕ

X DETACH WITH KNIFE
ОТДЕЛИТЬ НОЖОМ

2x QUANTITY OF OPERATIONS(PARTS)
КОЛИЧЕСТВО ОПЕРАЦИЙ(ДЕТАЛЕЙ)



USED PAINTS / ИСПОЛЬЗУЕМЫЕ КРАСКИ

A HUMBROL 147
LIGHT GREY
СВЕТЛО СЕРЫЙ

B HUMBROL 64
LIGHT GREY
СВЕТЛО СЕРЫЙ

C HUMBROL 33
BLACK
ЧЕРНЫЙ

D HUMBROL 156
DARK GREY
ТЕМНО СЕРЫЙ

E HUMBROL 19
RED
КРАСНЫЙ

F HUMBROL 101
MID GREEN
СРЕДНЕ ЗЕЛЕНЫЙ

G HUMBROL 27004
GUN METAL
СТАЛЬНОЙ СЕРЫЙ

H HUMBROL 87
GREY
СЕРЫЙ

J HUMBROL 62
LEATHER
КОЖА

K HUMBROL 145
MEDIUM GREY
СРЕДНЕ СЕРЫЙ

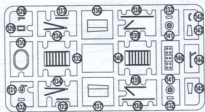
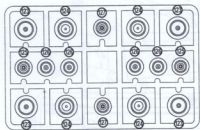
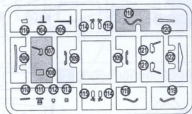
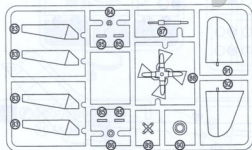
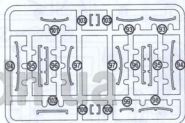
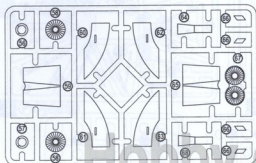
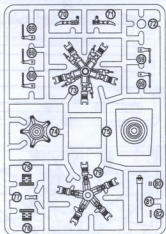
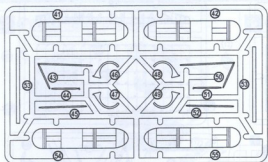

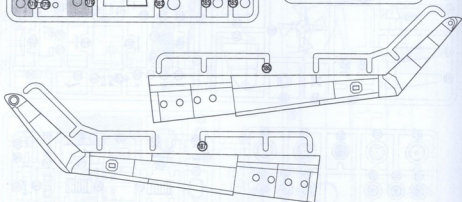
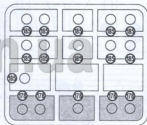
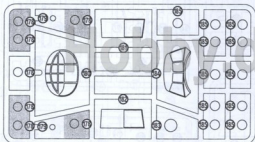
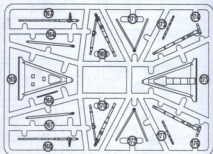
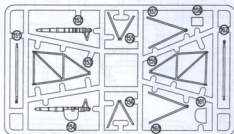
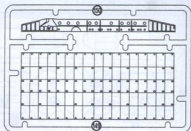
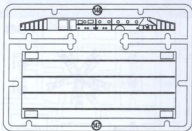

5X

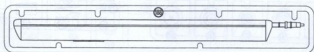

8  1 34 111 6x 185

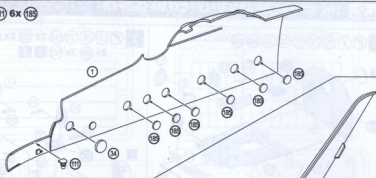

9  4x 185 187

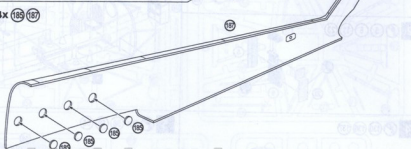

10  2 178 7x 185

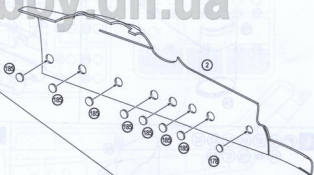

11  4x 185 186

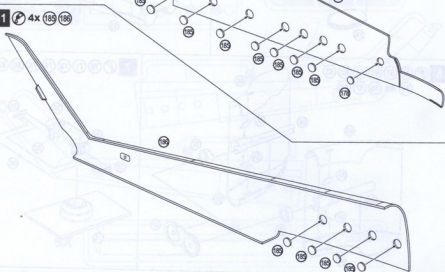

16  37 40 9 11

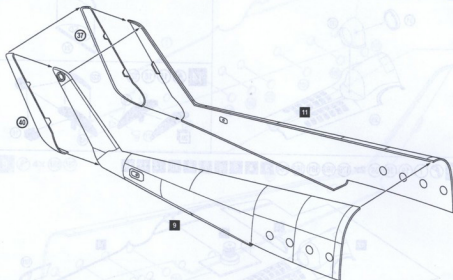

17  29 39 15 16

Hobby.dn.ua

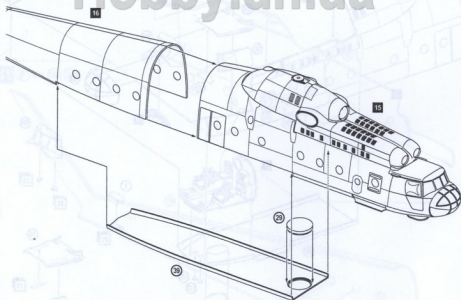

20 2x (123) 2x (124) (125) 2x (126) (127) 3x (132) (143) (151) (152) (156) (159) (160) (167) (171) (175) (176) 19

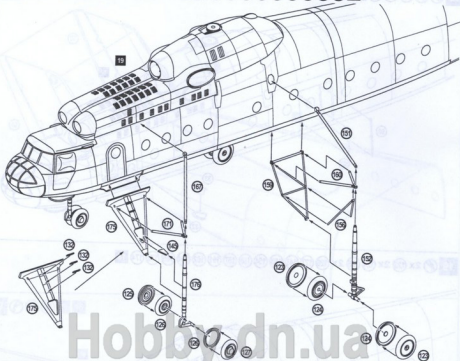

21 42 (48) (49) (50) (51) (52) (55) 20

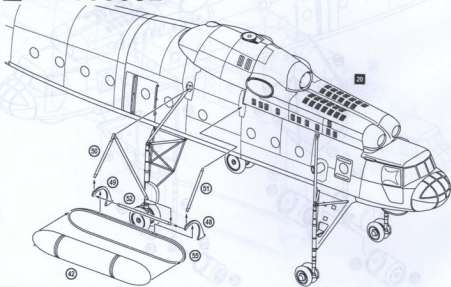



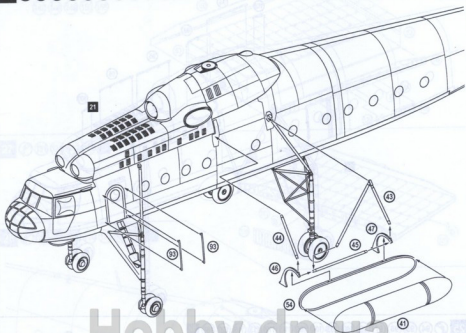



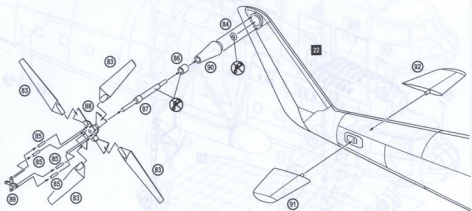



22  41 43 44 45 46 47 54 2x 93 21





23  4x 83 84 4x 85 86 87 88 89 90 91 92 22

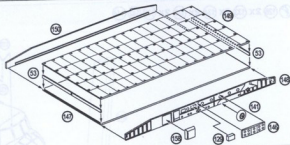

26  2x    
    



27      

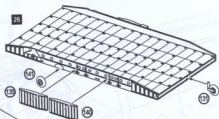

28         

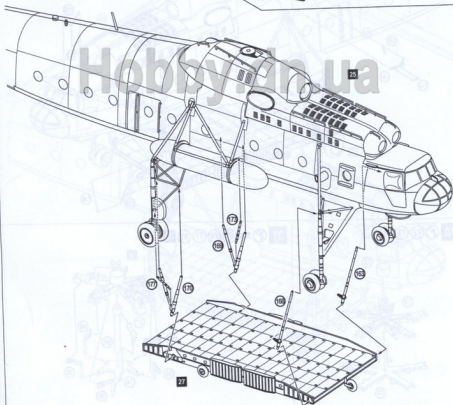

29  12x  2x  2x  2x  2x  2x  2x  2x  2x  2x  2x  2x

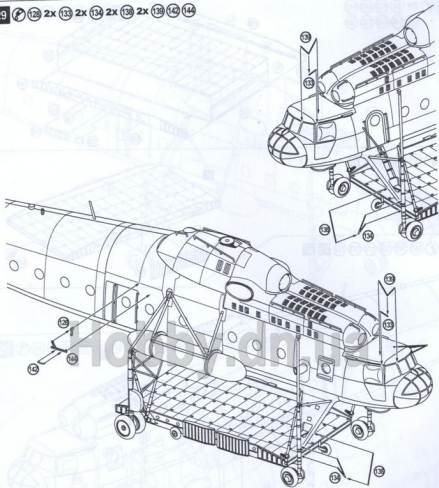

30  72  73  79

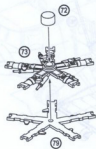

31  5x  69  74  77  81  30

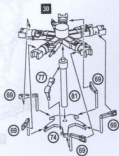

M-10, 181 IHR, Afghanistan, 80-th years
 М-10, 181 ОБТ, Афганистан, 80-е года

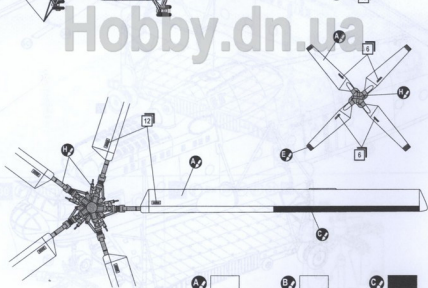
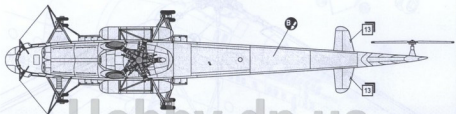
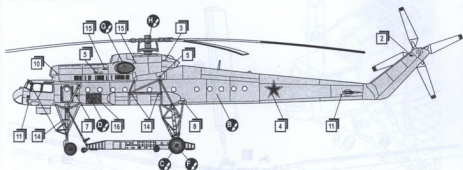

D  HUMBROL 156
DARK GREY
ТЕМНО СЕРЫЙ

E  HUMBROL 19
RED
КРАСНЫЙ

A  HUMBROL 147
LIGHT GREY
СВЕТЛО СЕРЫЙ

F  HUMBROL 101
MID GREEN
СРЕДНЕ ЗЕЛЕНЬ

B  HUMBROL 54
LIGHT GREY
СВЕТЛО СЕРЫЙ

G  HUMBROL 27004
GUN METAL
СТАЛЬНОЙ СЕРЫЙ

C  HUMBROL 33
BLACK
ЧЕРНЫЙ

H  HUMBROL 87
GREY
СЕРЫЙ

Mi-10 of the 3rd squadron of the 51st IGR, Ukraine, 1970s
 Ми-10, 3-я эскадрилья 51-го ОВБТ, Украина, 1970-е годы

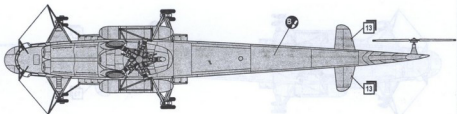
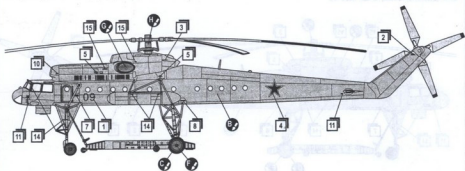

Hobby.dn.ua

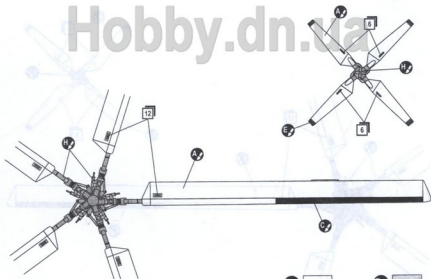

C HUMBROL 33
BLACK
ЧЕРНЫЙ

E HUMBROL 19
RED
КРАСНЫЙ

F HUMBROL 101
MID GREEN
СРЕДНЕ ЗЕЛЕНЫЙ

A HUMBROL 147
LIGHT GREY
СВЕТЛО СЕРЫЙ

G HUMBROL 27004
GUN METAL
СТАЛЬНОЙ СЕРЫЙ

B HUMBROL 54
LIGHT GREY
СВЕТЛО СЕРЫЙ

H HUMBROL 87
GREY
СЕРЫЙ

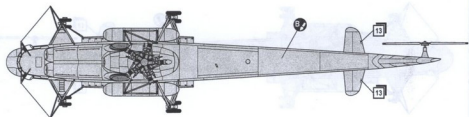
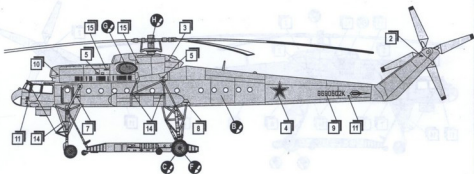

Hobby.dn.ua

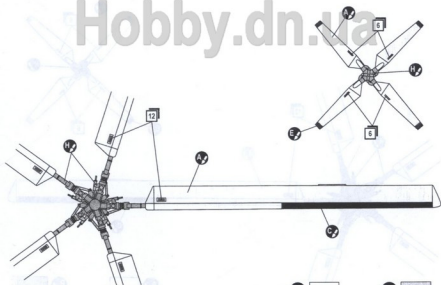

C 
 HUMBROL 33
 BLACK
 ЧЕРНЫЙ

E 
 HUMBROL 19
 RED
 КРАСНЫЙ

F 
 HUMBROL 101
 MD GREEN
 СРЕДНЕ ЗЕЛЕНЬ

A 
 HUMBROL 147
 LIGHT GREY
 СВЕТЛО СЕРЫЙ

G 
 HUMBROL 27004
 GUN METAL
 СТАЛЬНЫЙ СЕРЫЙ

B 
 HUMBROL 64
 LIGHT GREY
 СВЕТЛО СЕРЫЙ

H 
 HUMBROL 87
 GREY
 СЕРЫЙ