



Kit No.NB-5026

# USS 'Coronado' LCS-4

## 美国 LCS-4 濒海战斗舰“科罗拉多”号

### 1/350 SCALE



The USS Coronado is the second Independence Class littoral combat ship to be built by General Dynamics and Bath Iron Works. A contract for the ship was awarded in May 2009 and the ship should be completed by October 2012. It is expected that the ship will be identical to the USS Independence, an all-aluminum tri-maran designed for high speed operations in inshore waters. Payloads can be designed to suit the mission as much of the hull is of modular construction so can be quickly reconfigured to suit requirements. Main missions include mine laying/sweeping, anti-submarine warfare and anti-surface ship warfare. The ships are relatively small with a full load displacement of only 2,750 tons, compared to 10,000 tons for an Arleigh Burke class destroyer. 

Short Story by Philip Greenwood

Die USS CORONADO ist das zweite LCS Schiff der INDEPENDENCE Klasse, gebaut von General Electric und Bath Iron Works. Der Auftrag zur Herstellung erging im May 2009 und die Fertigstellung wird für Oktober 2012 erwartet. Wie die USS INDEPENDENCE (das Typschiff) wird die CORONADO ein Trimaran aus größtenteils Aluminium für Hochgeschwindigkeits Operationen in flachen Gewässern. Die Beladung kann den entsprechenden Missionen angepasst werden. Die modulare Auslegung erlaubt dies in kurzer Zeit. Hauptaufgaben sind Minenlegen/suchen, U-Bootabwehr und die Bekämpfung von Oberflächen Zielen. Die Abmessungen sind 127 m Länge und 30 m Breite. Der Tiefgang beträgt 4,5 m. Die LCS Schiffe sind mit nur ca. 2750 t Wasserverdrängung relativ klein gegenüber z. B. den Zerstörern der ARLEIGH BURKE Klasse. 

© Translation Michael Knoblich ACADEMY EUROPE GmbH 2010

美国海军“科罗拉多”号是通用动力公司及宝富钢铁公司所承建的第二艘“独立”号级濒海战斗舰。船的合同在2009年5月签定，而该舰应于2012年10月前完成试航交货。在预计中该船基本与首舰“独立”号是相同的，为铝材质三体高速船身设计。船上全是模块化装置，其可因应不同任务之需要而迅速更换该些设备。该船主要功能包括布雷、扫雷、反潜战和反水面作战等。其满载只是2,750吨，相比“伯克”级驱逐舰10,000吨的庞大身躯，其就显得比较娇小了。 

## ILLUSTRATION 图示说明:

### CORRECT METHOD FOR APPLYING DECALS : HINWEISE ZUM ANBRINGEN DER DECALS : 正确使用水贴纸的方法:

1. Clean model parts surface with wet cloth. Entsprechende Stellen am Modell feucht reinigen.  
将需要贴水贴之部位表面擦干净。
2. Cut out the decal parts and dip them in cold water for 15 ~20 seconds. Decal ausschneiden und für 15-20 Sek. ins Wasser legen.  
将所需之贴纸剪下泡在清水里约15至20秒。
3. Place it on correct position of the model kit. Decal an der richtigen Stelle auflegen.  
将湿透之贴纸取出置放于正确之位置旁。
4. Slide off the decal from the base paper on to the model kit surface with a cotton stick. Decal mit Wattestäbchen festhalten und Papier darunter wegziehen.  
用棉花棒轻推贴纸表面使其从底纸滑出至模型表面之正确位置。
5. When decal get dry then complete. Decal mit Papiertuch andrücken und trocknen.  
待其自然干透后即完成。

### ICON INSTRUCTION: 图标说明:

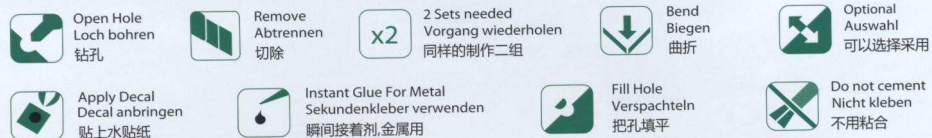

Color 涂料表	MR. Hobby	Hobby Color	Humbrol	Tamiya
Steel Stahl 黑铁色	H-18	C-28	53	/
Clear blue 透明蓝	C-50	H-93	X-23	/
Dark yellow 暗黄色	H-78	C-39	83	XF-60
Tyre black Reifenschwarz 轮胎黑	H-77	C-137	85	/
Flat black Mattschwarz 消光黑	H-12	C-33	33	XF-1
Red Rot 红色	H-3	C-3	19	X-7
Gray Grau (FS36118) 灰色	H-305	C-305	125	/
Gray Grau (FS35270) 灰色	H-306	C-306	126	/
Neutral gray 中性灰	H-307	C-13	96	XF-10
White Weiss 白色	H-1	C-1	/	X-2

### Read Before Assembling: Vor Zusammenbau lesen:

### 组装必读:

- Carefully Study instruction before assembling. Anleitung studieren und verständlich machen. 组装前请阅读清楚制作指引。
- Keep plastic model glue and tools away from children. Kleber, Farben, Werkzeuge und Plastiktüten von Kindern fernhalten. 胶水、油漆及工具勿让小孩接触。
- Do not use cement or paint near open flame or sparks. Kleber/Farbe nicht in Nähe von offenen Flammen. 胶水及油漆勿接触火种。
- Do not work in closed room. Nur in ausreichend belüfteten Räumen arbeiten. 勿在密封地方制作模型。

PARTS LIST 零件展示表:



**BRONCO**  
Bronco Models

Copyright © 2012  
Made in China  
中国制造



No use parts  
不要部件

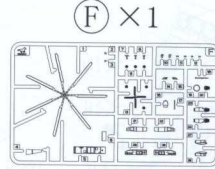

F × 1

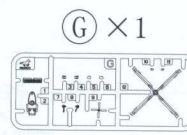

G × 1

N × 1

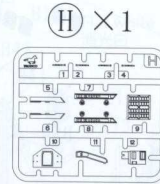

H × 1

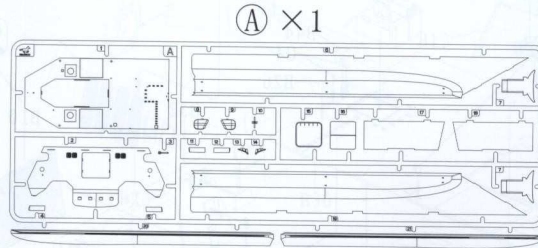

A × 1



I × 1

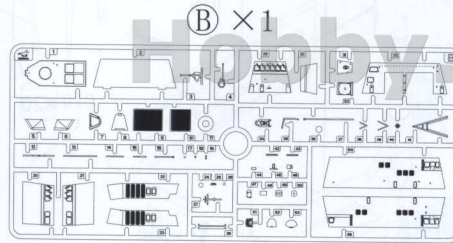

B × 1

Fa × 1

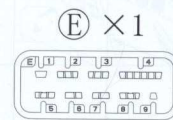
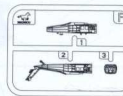

E × 1

C × 2

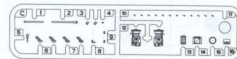

DECAL × 1

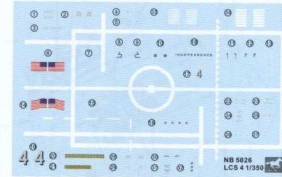

Ga × 1

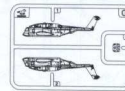

D × 1

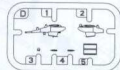

M × 1

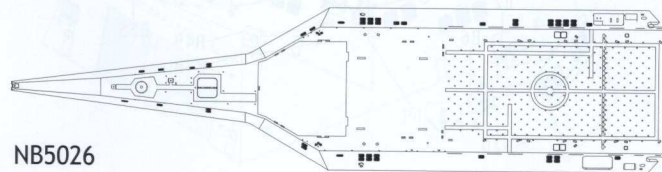

NB5026

P × 1

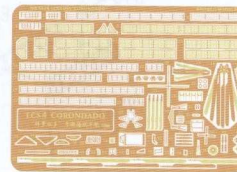

ILLUSTRATION 图示说明:

1

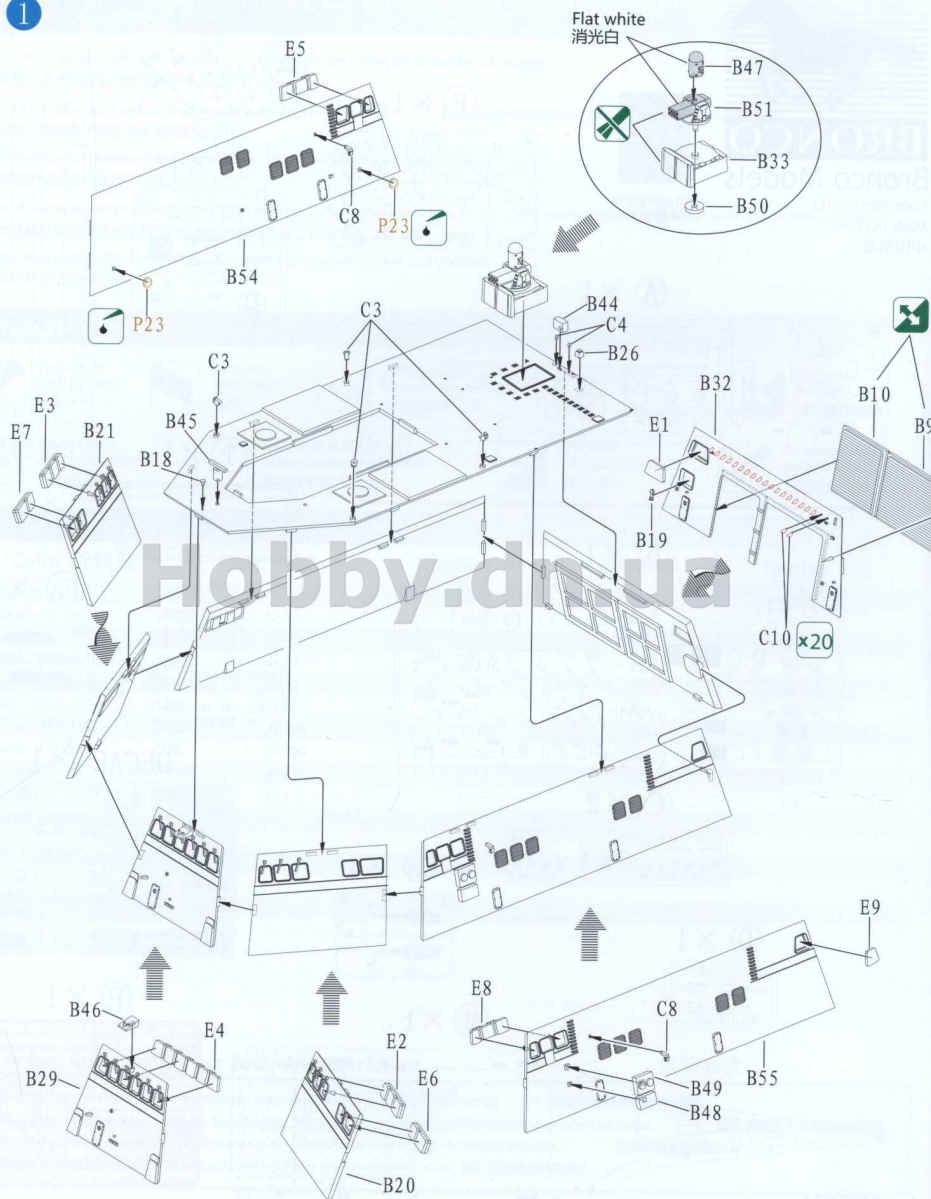
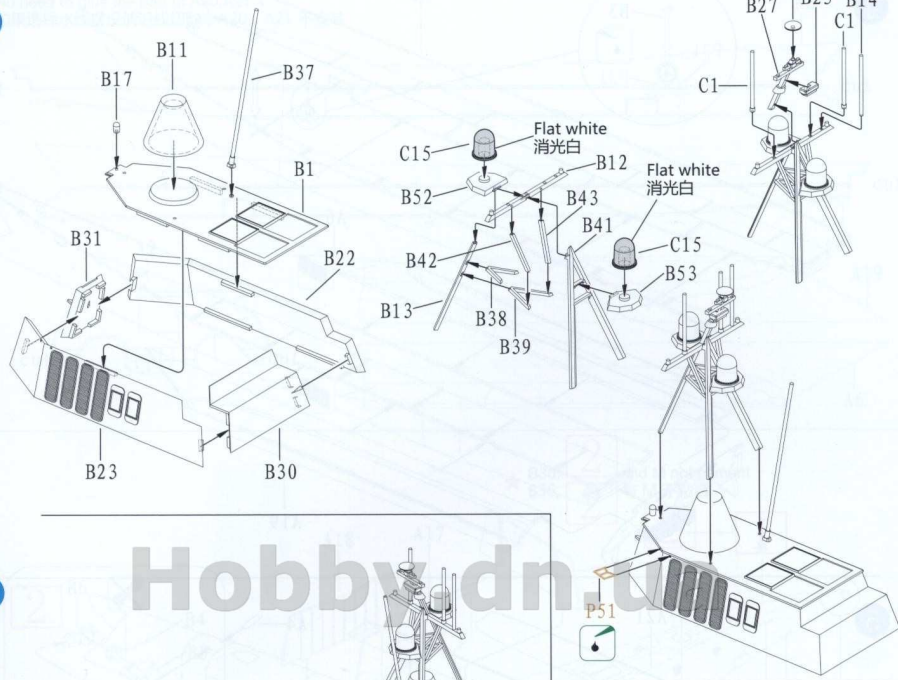

ILLUSTRATION 图示说明:

2



3

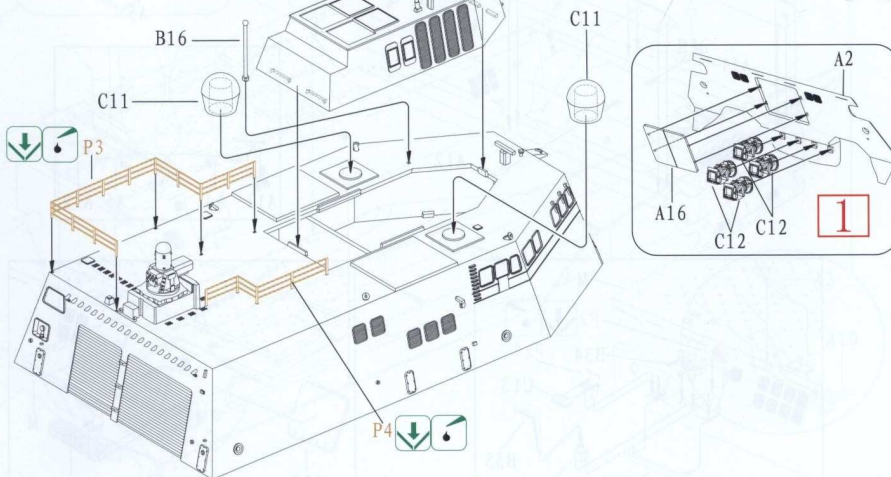
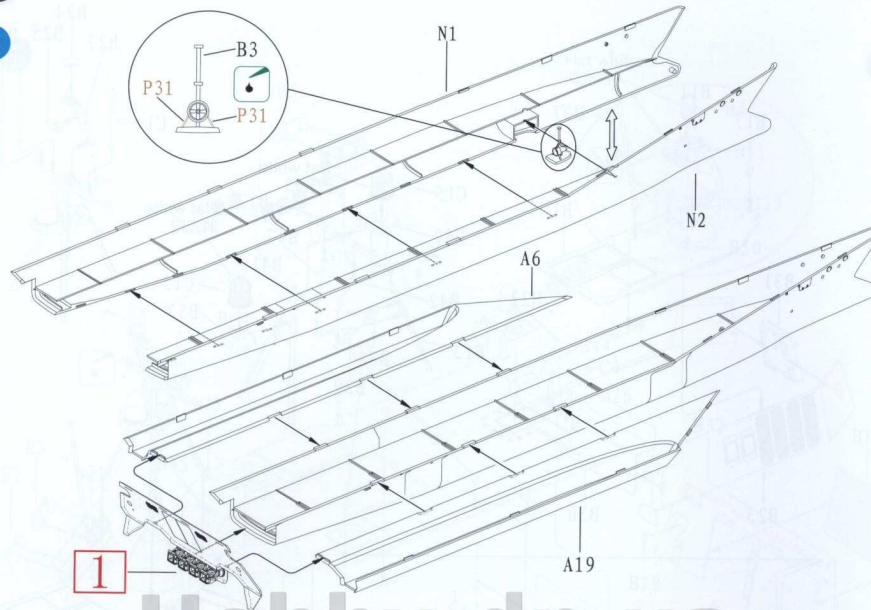

ILLUSTRATION 图示说明:

4



5

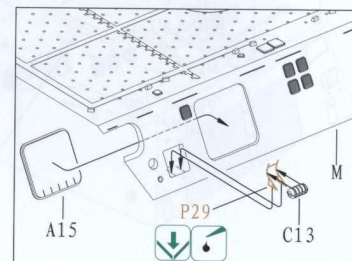
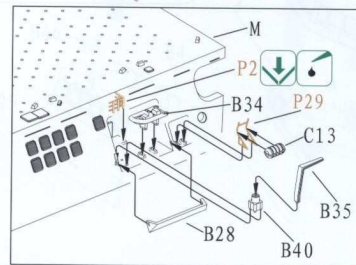
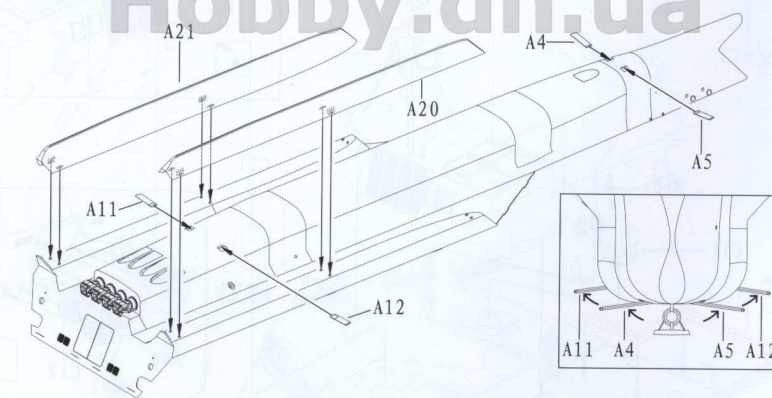
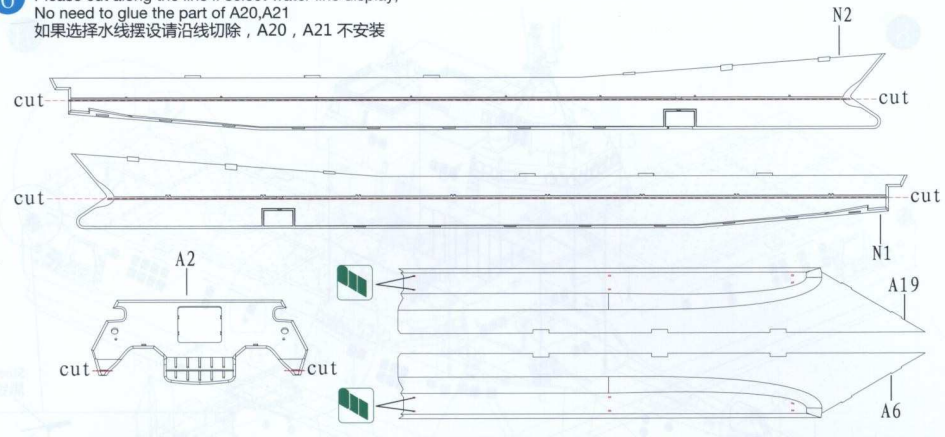

ILLUSTRATION 图示说明:

- 6 Option:  
Please cut along the line if select water line display,  
No need to glue the part of A20,A21  
如果选择水线摆设请沿线切除, A20, A21 不安装



7

- ★ B36, 2 and M not cement  
B36, 2 与 M 不粘

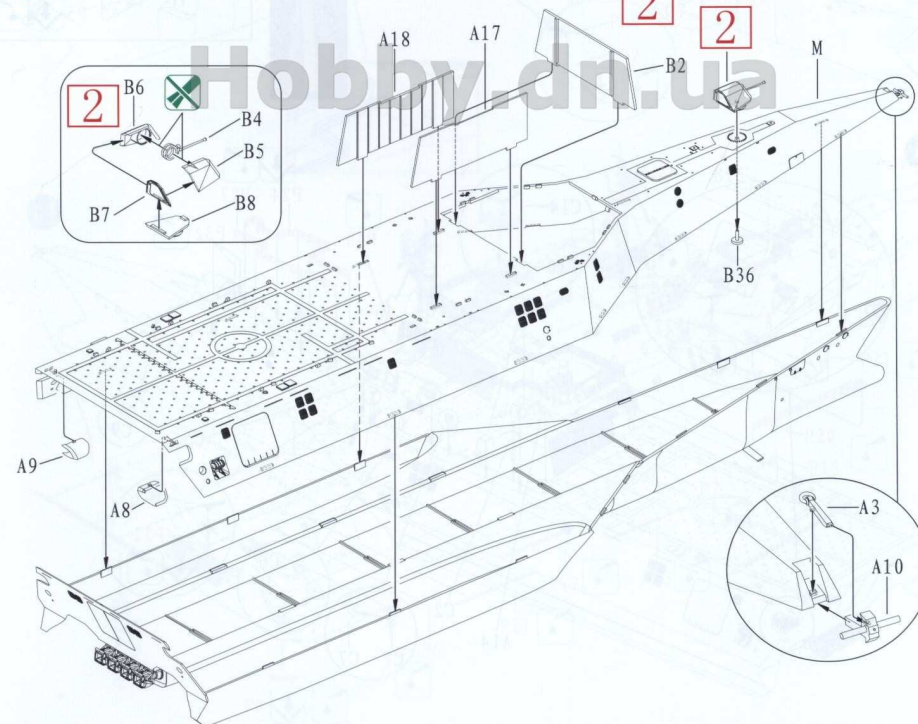
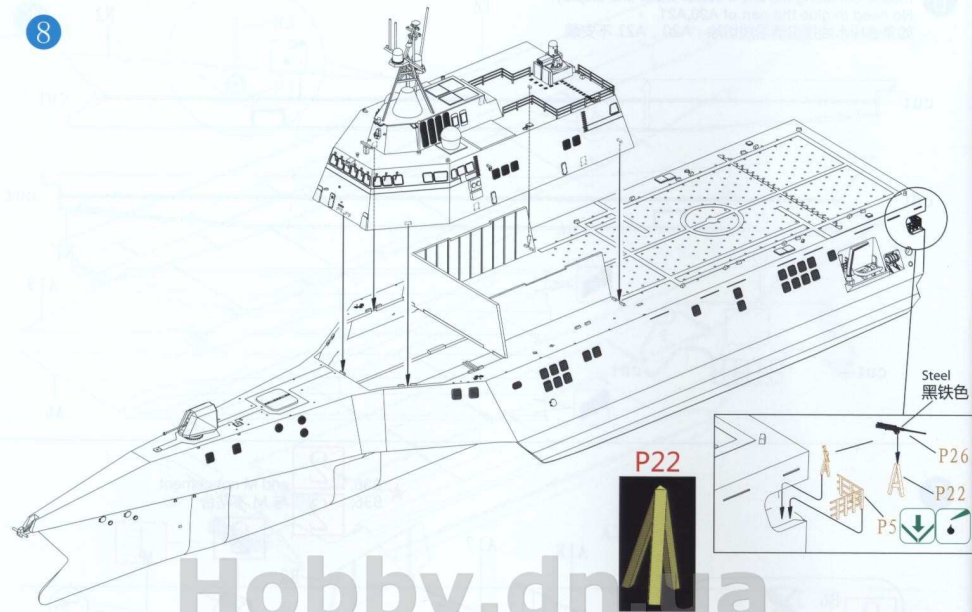
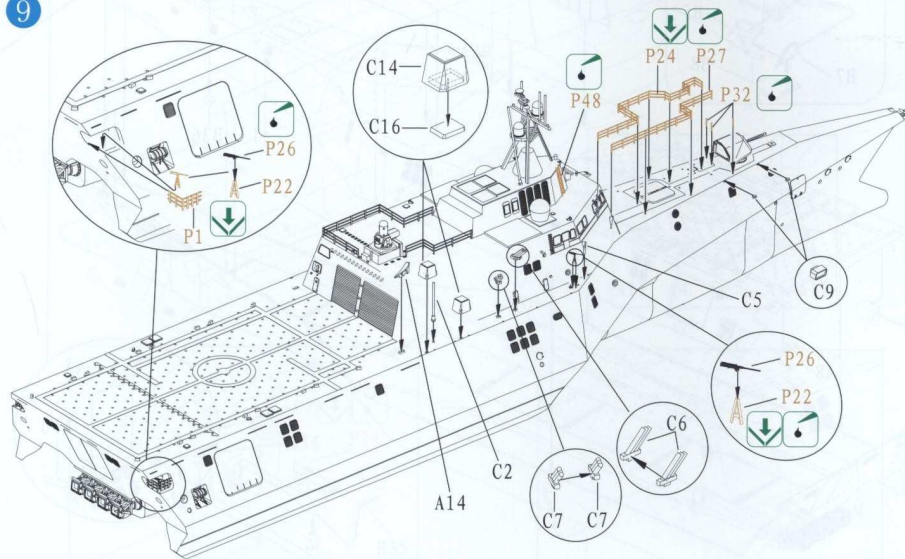

ILLUSTRATION 图示说明:

8



9





10

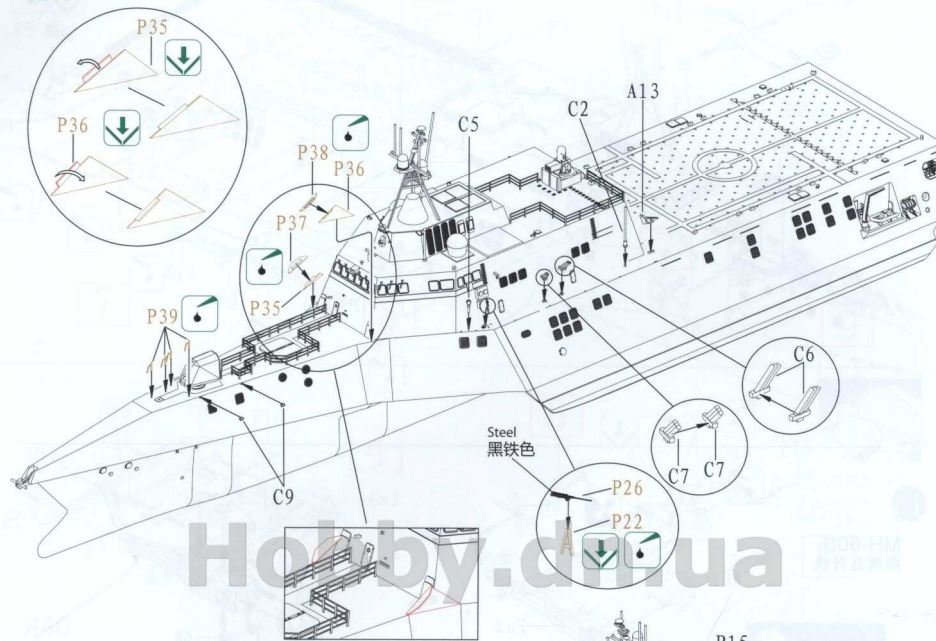

11

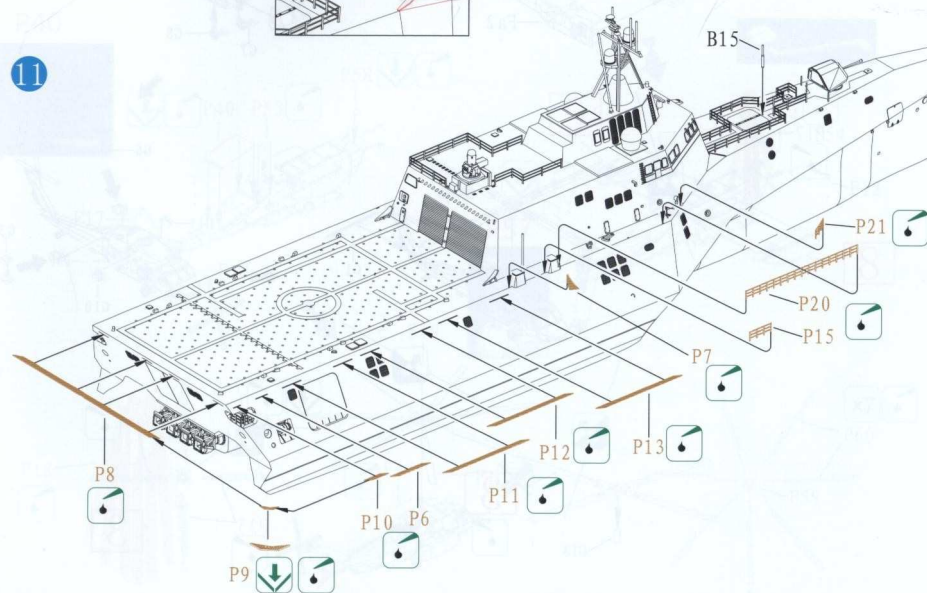
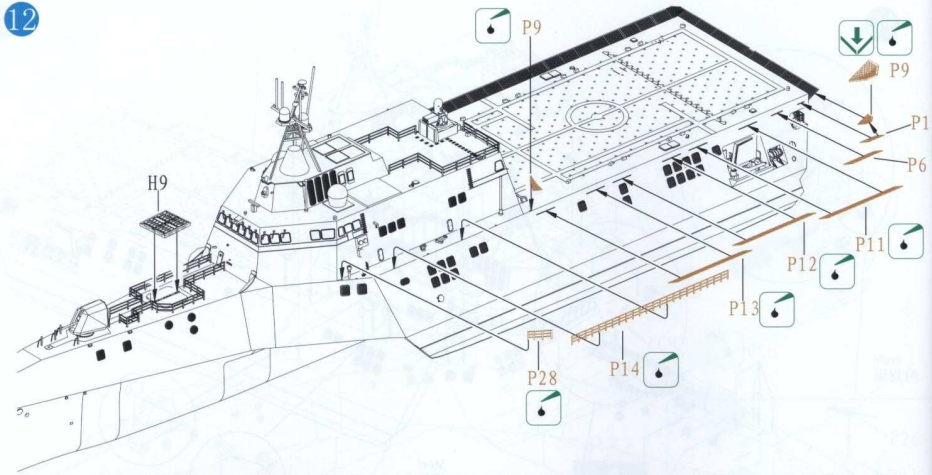

ILLUSTRATION 图示说明:

12



13

MH-60S  
海鹰直升机

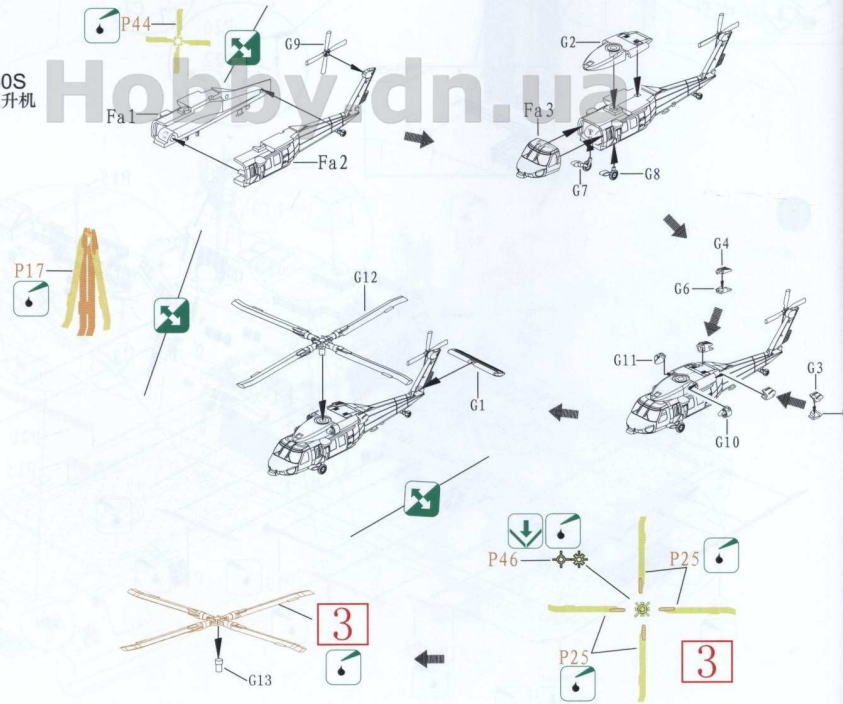
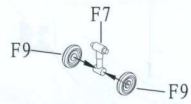
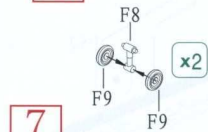

ILLUSTRATION 图示说明:

14 MH-53E Sea Dragon  
海龙直升机



4



7

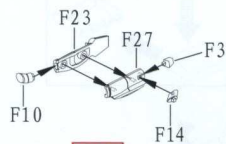

5

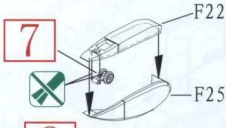

7

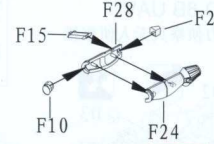

6

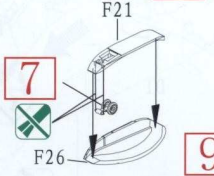

7

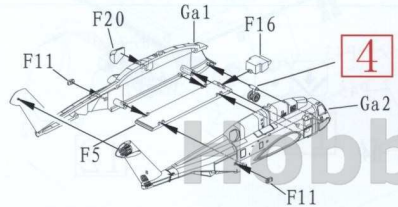

4

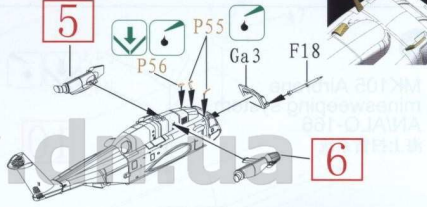

5

6

P40



9

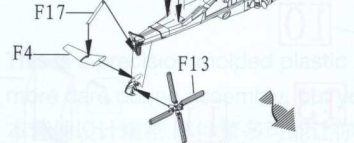

8



P57



9

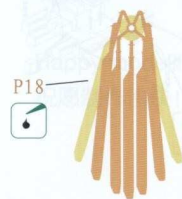

P18



P47



P60

P59

x7

ILLUSTRATION 图示说明:

15 MQ-8B UAV  
火力侦察兵无人侦察机

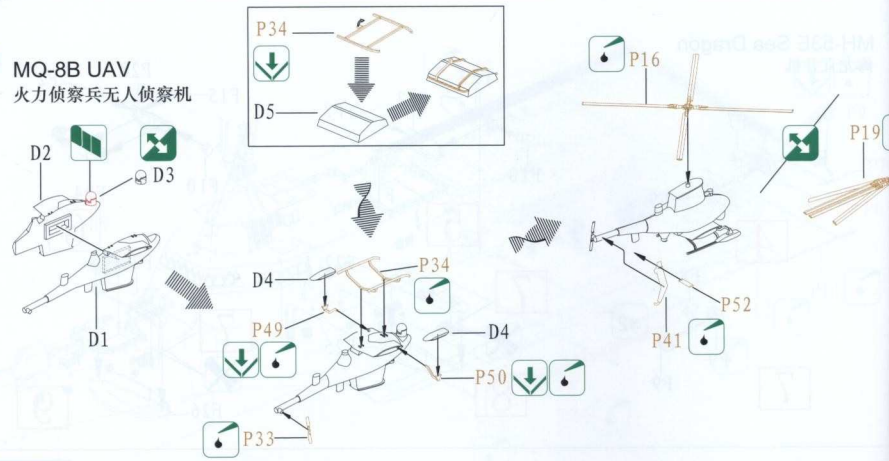

16 MK105 Airborne  
minesweeping system  
AN/ALQ-166  
海上扫雷系统

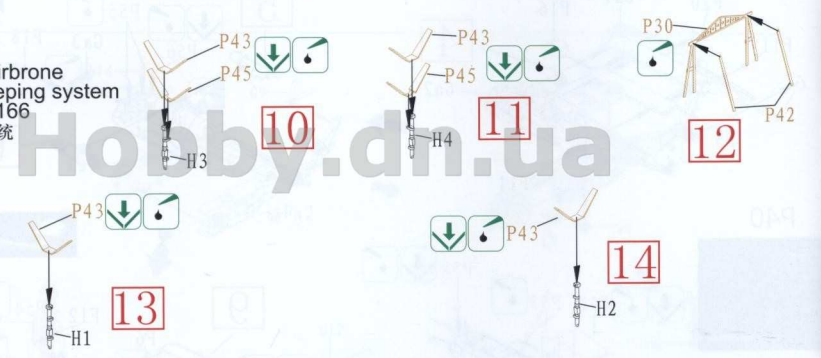

17

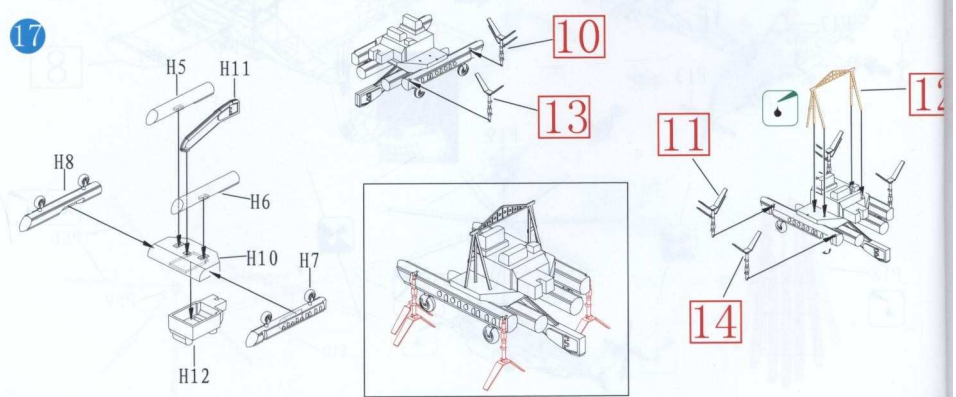

18

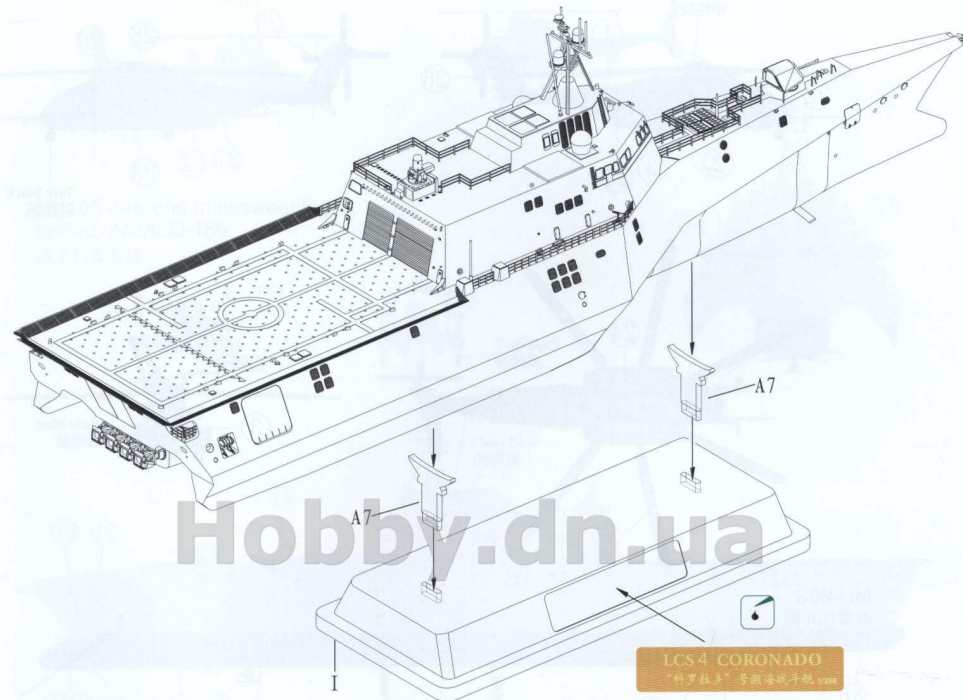

★ This is a precision molded plastic kit with exceptionally fine detail. It will require a little more care during assembly, but you feel the end result is well worth the effort.  
 本套件设计精密,零件繁多可能让你在制作过程中有所不便,但完成后会让你产生无穷之成功快感。

Happy modelling!  
 祝愿制作愉快!

DECAL & COLOUR GUIDE 水贴及涂色指示:

MH-53E Sea Dragon  
海龙直升机

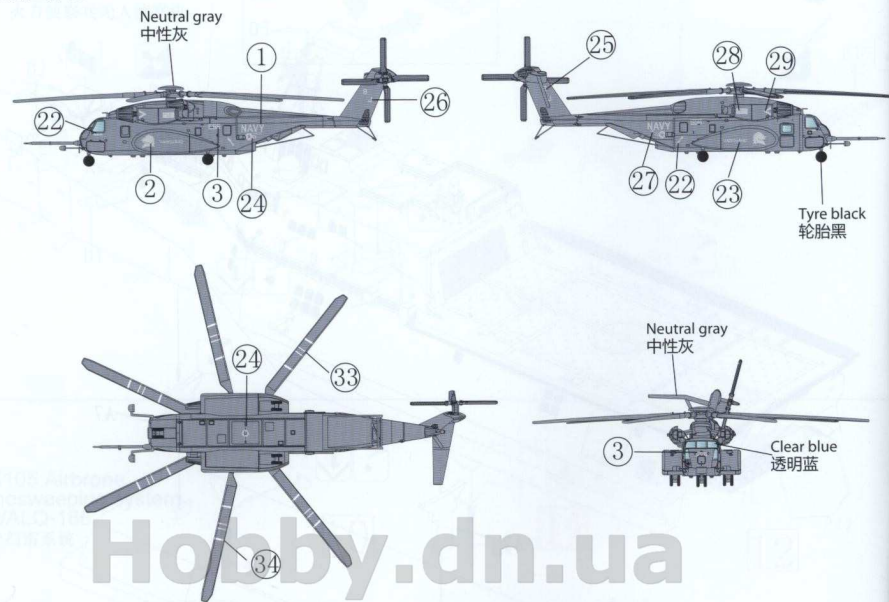

MH-60S  
海鹰直升机

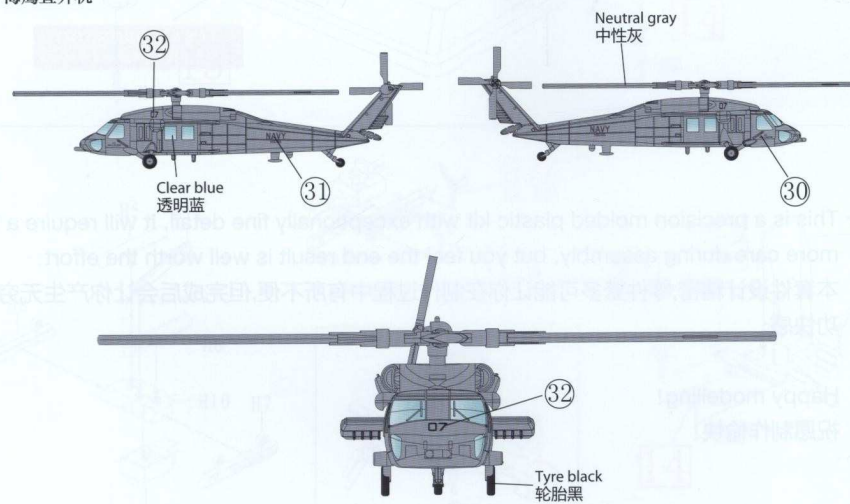

DECAL & COLOUR GUIDE 水贴及涂色指示:

MH-60S  
火力侦察兵无人侦察直升机

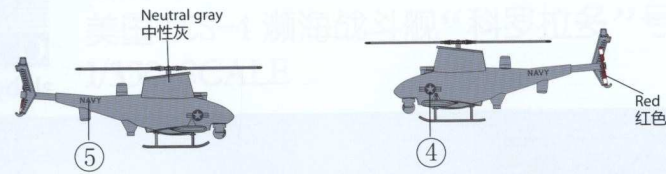

MK105 Airborne minesweeping system AN/ALQ-166  
海上扫雷系统

