

1:35

LVT-4

Water Buffalo

BONUS

U.S. MARINES (IWO JIMA 1945)

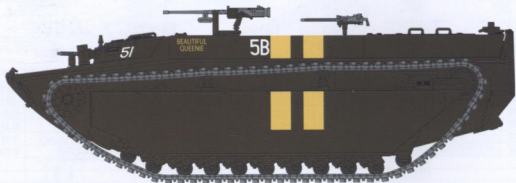

cyber-hobby.com

KIT NO. 9134

A

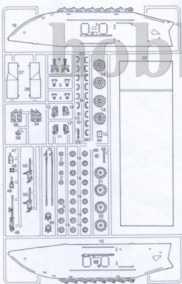

B

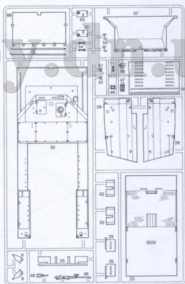

Dx2

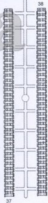

C

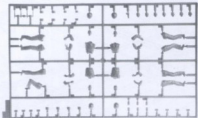
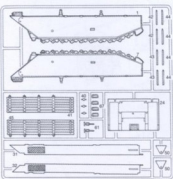

E



この部品は使用してはなりません。
Parts not for use.
Teile werden nicht verwendet.
Pièces a ne pas utiliser.
Parti non utilizzati.
不要部品の部材

組立ての注意

- 接着剤や塗料は火の近くで使用しないでください。使用する際は必ず取手で確実に手を付けましょう。
- 塗料指定の **■**は GSI CREOS CORP. 各カラーの番号です。
- 接着剤や塗料は塗られておりませんので、顔に塗りたくらないでください。
- 部品をランナーから切り離す時は模型用ハサミ等を使用し、余分な部分はカッターやヤスリ等で仕上げてください。
- 組立後のサインマークは下記をご覧ください。

【注意】

- 近接火気使用禁止（水・油塗）：並打閉塞戸保持空気流通。
- **■**代表 GSI CREOS CORP. 出品 MR. COLOR の顔色編號。
- 不包括水及油塗。
- 自製中取出部材料：適用模型専用材、並用刃刀或小鋸除去多餘的原料。
- 各圖型的合意可參考本圖以下之說明。

ZUR BEACHTUNG

- Kleber und Farbe nicht in der Naher offener Feuer verwenden und das Fenster von Zeit zu Zeit zur Beluftung offnen.
- Symbole wie **■** beziehen sich auf die Farbrummern GSI CREOS CORP. MR. COLOR. Kleber und Farbe sind nicht enthalten.
- Zum Abschneiden der Teile vom Verbundblech eine Modellierschere verwenden und die uberehenden Plastikteile mit einem Messer oder einer Feile beseitigen.
- Die Bedeutung der Symbole finden Sie unten in dieser Spalte.

CAUTION

- When you use glue or paint, do not use near a naked flame, and in a well-ventilated room.
- Symbols such as **■** refer to the color number of GSI CREOS CORP. MR. COLOR. Glue and paint are not included.
- When you take parts off the runner frame, use modeling scissors and trim excess plastic with a cutter or a file.
- See below for the meaning of symbols.

ATTENTION

- Ne pas utiliser de colle ou de peinture a proximite d'une flamme nue, et aevrer la piece de temps en temps.
- Le numero **■** pour l'indication de couleurs correspond au numero de GSI CREOS CORP. MR. COLOR. La colle et la peinture ne sont pas comprises.
- Pour retirer les pieces hors du cadre, utiliser des ciseaux speciaux pour maquette et une lime ou une eplaneuse.
- Voir le fin de cette colonne pour la signification des symboles.

ATTENZIONE

- Non usare colla e vernice vicino a fiamme scoperte, e aprire le finestre di tanto in tanto per cambiare l'aria.
- **■** delle indicazioni di colore si riferiscono al numero di colore di GSI CREOS CORP. MR. COLOR. Colla e vernice non sono incluse.
- Quando si estracono parti del camice, usare forbici da modellismo e eliminare la plastica in eccesso con un coltello a lima.
- Vedere in fondo a questa colonna per il significato dei simboli.

- 2** 上塗りでください
PAINT TOP
STUFFE FERTIGER
REFLECTOR FERTIG
FINIS DUE PIZZ
TOP LIFT
SOI 1.50
上塗り済
- 1** 穴を塗ってください
BE GUMMED
HIER VERBODEN
HIER ATTENTION
HIER VERBODEN
FORNITEST
穴塗済

- 1** 穴を塗ってください
BE GUMMED
HIER VERBODEN
HIER ATTENTION
HIER VERBODEN
FORNITEST
穴塗済
- 2** 上塗りでください
PAINT TOP
STUFFE FERTIGER
REFLECTOR FERTIG
FINIS DUE PIZZ
TOP LIFT
SOI 1.50
上塗り済

- 1** 穴を塗ってください
BE GUMMED
HIER VERBODEN
HIER ATTENTION
HIER VERBODEN
FORNITEST
穴塗済
- 2** 上塗りでください
PAINT TOP
STUFFE FERTIGER
REFLECTOR FERTIG
FINIS DUE PIZZ
TOP LIFT
SOI 1.50
上塗り済

- 1** 穴を塗ってください
BE GUMMED
HIER VERBODEN
HIER ATTENTION
HIER VERBODEN
FORNITEST
穴塗済
- 2** 上塗りでください
PAINT TOP
STUFFE FERTIGER
REFLECTOR FERTIG
FINIS DUE PIZZ
TOP LIFT
SOI 1.50
上塗り済

- 1** 穴を塗ってください
BE GUMMED
HIER VERBODEN
HIER ATTENTION
HIER VERBODEN
FORNITEST
穴塗済
- 2** 上塗りでください
PAINT TOP
STUFFE FERTIGER
REFLECTOR FERTIG
FINIS DUE PIZZ
TOP LIFT
SOI 1.50
上塗り済

- 1** 穴を塗ってください
BE GUMMED
HIER VERBODEN
HIER ATTENTION
HIER VERBODEN
FORNITEST
穴塗済
- 2** 上塗りでください
PAINT TOP
STUFFE FERTIGER
REFLECTOR FERTIG
FINIS DUE PIZZ
TOP LIFT
SOI 1.50
上塗り済

- 1** 穴を塗ってください
BE GUMMED
HIER VERBODEN
HIER ATTENTION
HIER VERBODEN
FORNITEST
穴塗済
- 2** 上塗りでください
PAINT TOP
STUFFE FERTIGER
REFLECTOR FERTIG
FINIS DUE PIZZ
TOP LIFT
SOI 1.50
上塗り済

H ■ GSI CREOS CORP. AQUEOUS HOBBY COLOR ■ GSI CREOS CORP. MR. COLOR ■ MODEL MASTER COLOR

色番	色名	色番	色名	色番	色名	色名	
H03	レッド(赤)	1503	RED	ROT	ROUGE	ROSSO	紅色
H07	シルバー(銀)	1546	SILVER	SILBER	ARGENT	ARGENTO	銀色
H12	つや消しブラック	1749	FLAT BLACK	MATTSCHWARZ	NOIR MAT	NERO OPACO	啞黑色
H18	黒鉄色	1415	STEEL	STAHL	ACIER	ACCIAIO	黒鋼色
H37	ウッドブラウン	1735	WOOD BROWN	HOLZBRAUN	BRUN BOIS	MARRONE LEGNO	木棕色
H300	オーブドラブFS34087	1711	OLIVE DRAB	OLIVE DRAB	OLIVE DRAB	OLIVA PALLIDO	橄欖綠色

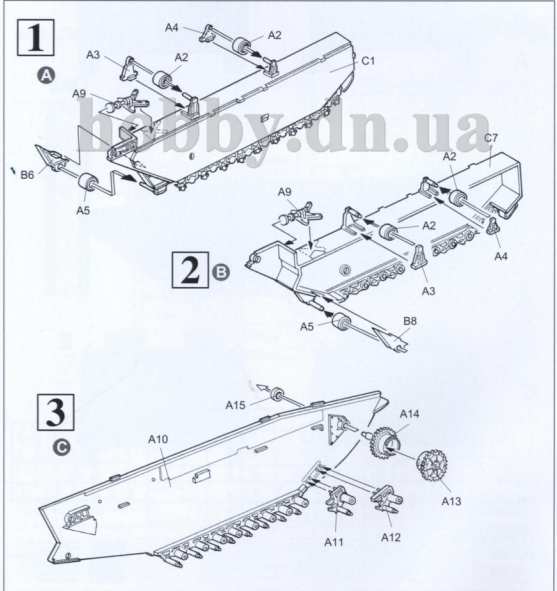

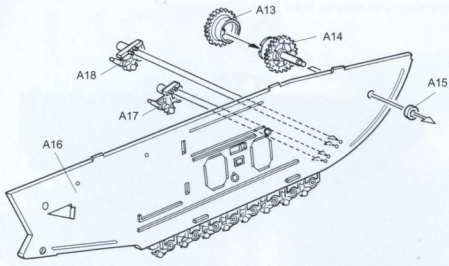
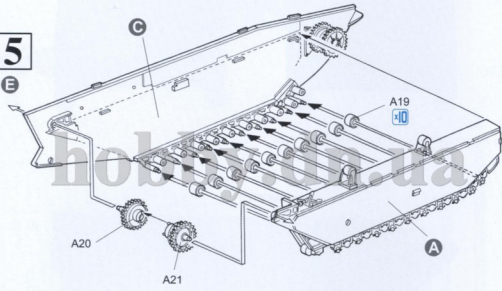
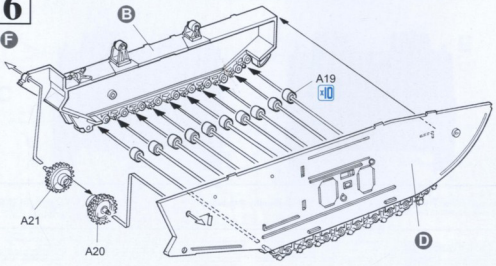
4**D****5****E****6****F**

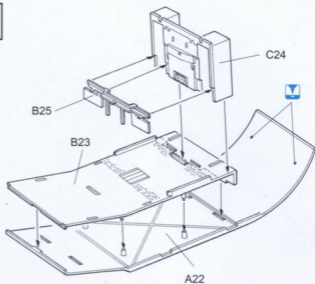
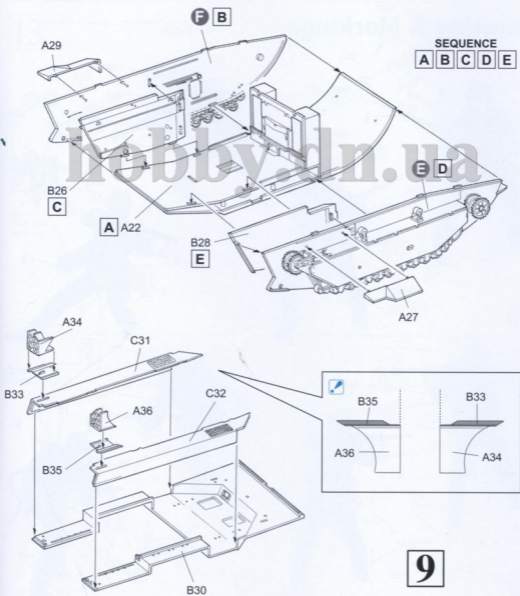
7**8****9**

10

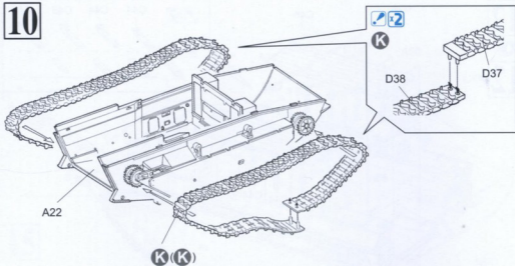

11

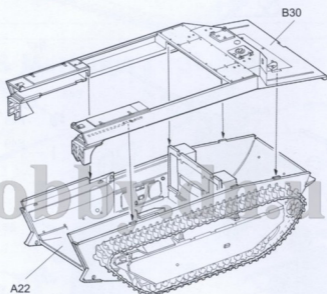

12

12

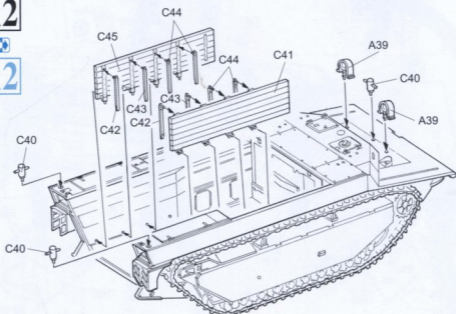

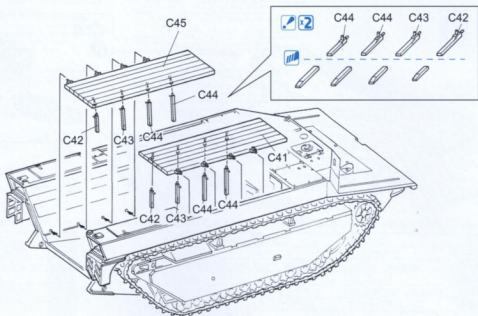
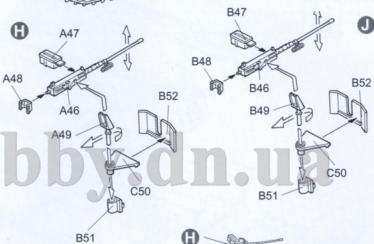
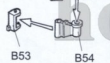
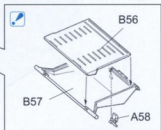
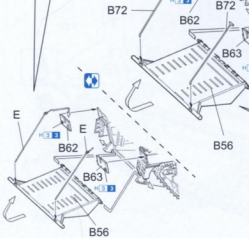
12**12****13****14**

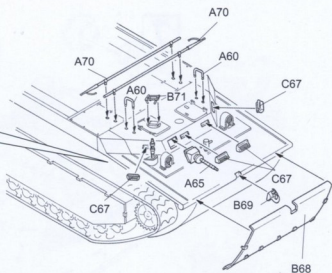
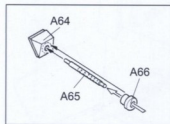

15

Painting & Markings

マーキング及び塗装図 Markierungen und Bemalung Decoration et Peinture
 Marchio e Pitture 標記及着色指示

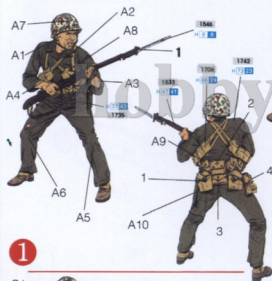

1



2

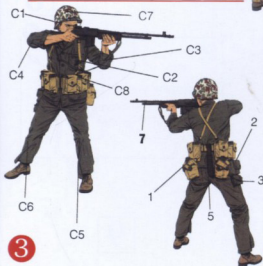

3

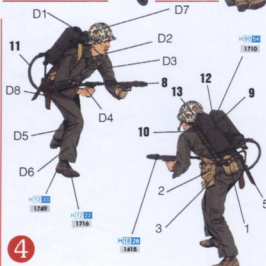

4

10th Amphibian Tractor Battalion, Yellow Beach 2, Iwo Jima 1945

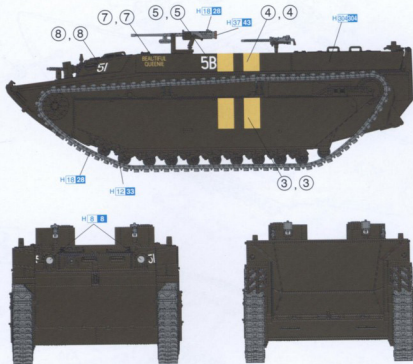

11th RTR, 79th Armoured Div., Netherlands 1944

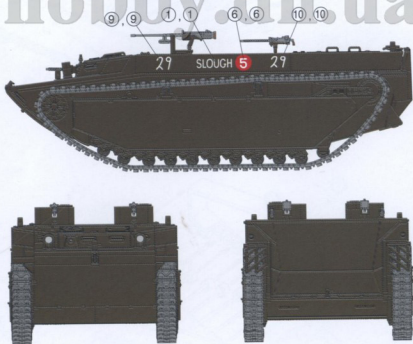

Dragon Europe: c/o Hobby Pro Marketing Ges. m.b.H.
Am Leonhardbach 7, A-8010 GRAZ, AUSTRIA

A Quality Product of



Copyright © 2011
9134-01

Dragon Europe: c/o Hobby Pro Marketing Ges. m.b.H.
Am Leonhardbach 7, A-8010 GRAZ, AUSTRIA

Current Method for Applying Decals
 1. Clean the model surface with a soft cloth.
 2. Remove the decal from the sheet and apply it to the model with a soft brush.
 3. Use a brush to smooth the decal into the surface of the model.
 4. If the decal does not adhere, use a soft brush to apply a thin layer of water to the surface of the model and the decal.
 5. After the decal is in place, use a soft brush to gently remove any excess water.

Wie aktuellste Aufkleber für Modelle
 1. Reinigen Sie das Modell mit einem weichen Tuch.
 2. Entfernen Sie den Aufkleber von der Folie und kleben Sie ihn auf das Modell mit einem weichen Pinsel.
 3. Verwenden Sie einen Pinsel, um den Aufkleber in die Oberfläche des Modells zu drücken.
 4. Wenn der Aufkleber nicht anhaftet, verwenden Sie einen Pinsel, um eine dünne Schicht Wasser auf die Oberfläche des Modells und den Aufkleber zu geben.
 5. Nach dem Aufkleben des Aufklebers verwenden Sie einen weichen Pinsel, um überschüssiges Wasser abzuwischen.

Metodo attuale per applicare le decalcomanie
 1. Pulire il modello con un panno morbido.
 2. Rimuovere il decalcomano dalla foglia e applicarlo al modello con un pennello morbido.
 3. Usare un pennello per premere il decalcomano sulla superficie del modello.
 4. Se il decalcomano non si attacca, usare un pennello per applicare una sottile strato d'acqua sulla superficie del modello e il decalcomano.
 5. Dopo aver applicato il decalcomano, usare un pennello morbido per rimuovere l'acqua in eccesso.

Metode terbaru untuk menerapkan stiker
 1. Bersihkan model dengan kain lembut.
 2. Lepaskan stiker dari lembaran dan tempelkan ke model dengan kuas lembut.
 3. Gunakan kuas untuk menekan stiker ke permukaan model.
 4. Jika stiker tidak menempel, gunakan kuas untuk menerapkan lapisan tipis air ke permukaan model dan stiker.
 5. Setelah stiker diterapkan, gunakan kuas lembut untuk menghilangkan kelebihan air.

Dragon Europe: c/o Hobby Pro Marketing Ges. m.b.H.
Am Leonhardbach 7, A-8010 GRAZ, AUSTRIA