



**Vor dem Zusammenbau lesen!**

## READ BEFORE ASSEMBLY

### CAUTION

- Read carefully and fully understand the instructions before commencing assembly. A supervising adult should also read the instructions if a child assembles the model.
- When assembling this kit, tools including knives used. Extreme care should be taken to avoid personal injury.
- Keep out of reach of small children. Children must not be allowed to suck any part, or pull vinyl bag over their heads.



## PAINTS REQUIRED

Color info and profiles by Mig Jimenez

A.MIG-0005 Dark Tracks	A.MIG-0003 Rubber & Tires	A.MIG-0045 Gun Metal	A.MIG-0008 Old Wood
A.MIG-0002 Satin Black	A.MIG-0006 Crystal Periscope Green	A.MIG-0010 RAL 7028 Dunkelgelb (Mid War)	A.MIG-0007 New Wood
A.MIG-0001 RAL 6003 Olivgrün Opt. 1	A.MIG-0004 Washable White Camo		

## APPLYING DECALS

1. Clean the model surface with a wet cloth.
2. Cut out each decal design from sheet, and dip it in tepid water for 15-20 sec.
3. Hold the backing sheet edge and slide decal onto the model.
4. Move decal into position by wetting decal with finger.
5. Press decal gently down with a soft cloth until excess water and air bubbles are gone.

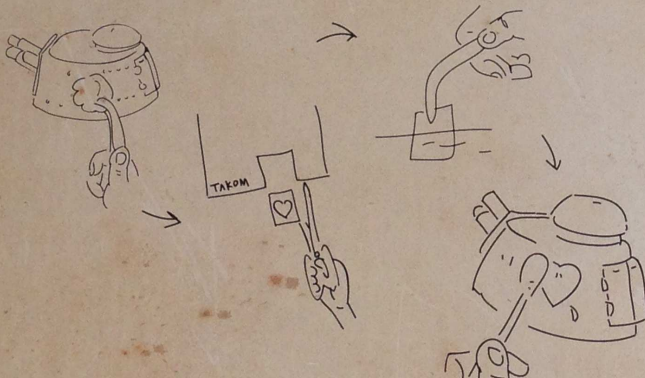

## REMOVING PE

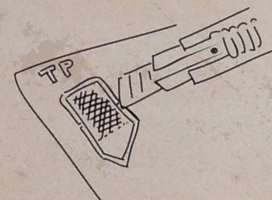

Be careful not to hurt when removing PE parts.



Secure using instant glue (not included).



Finish using file.







2

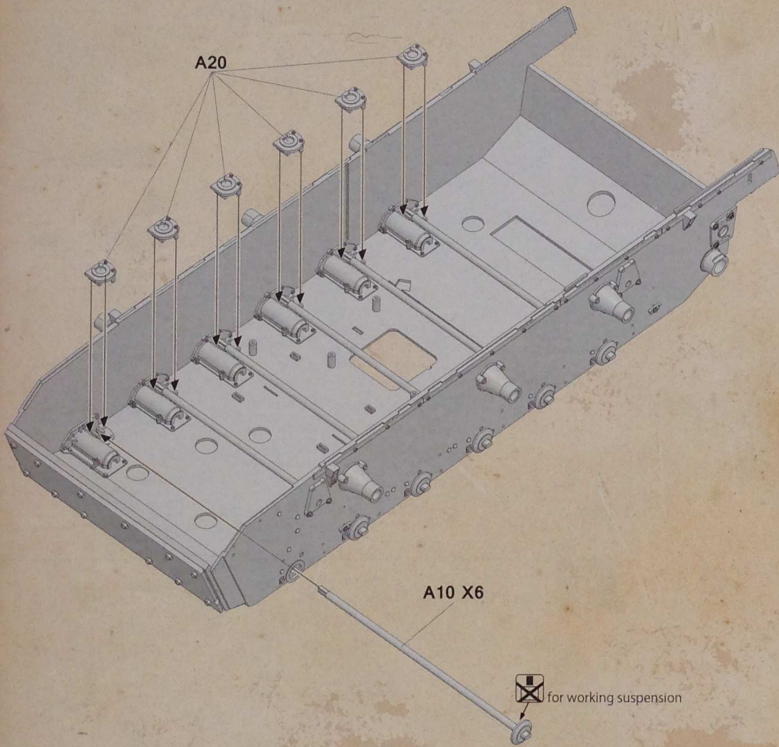

3

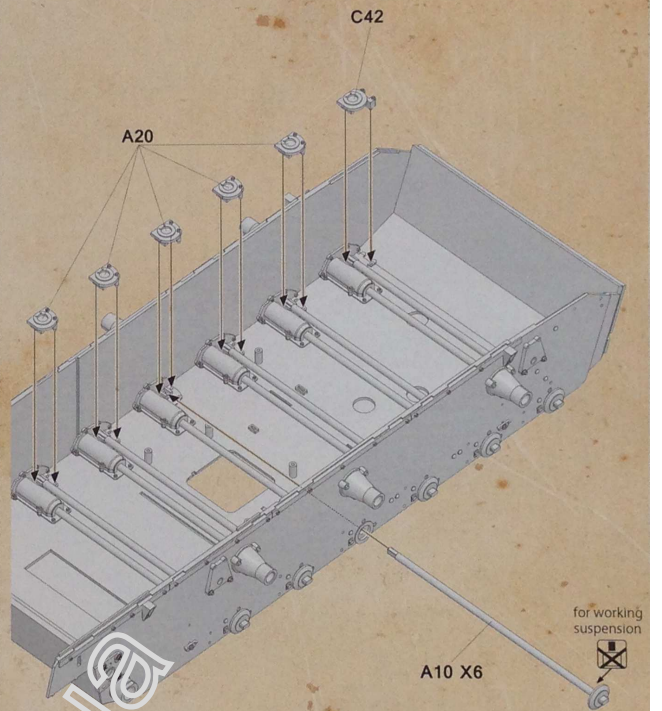

4

4

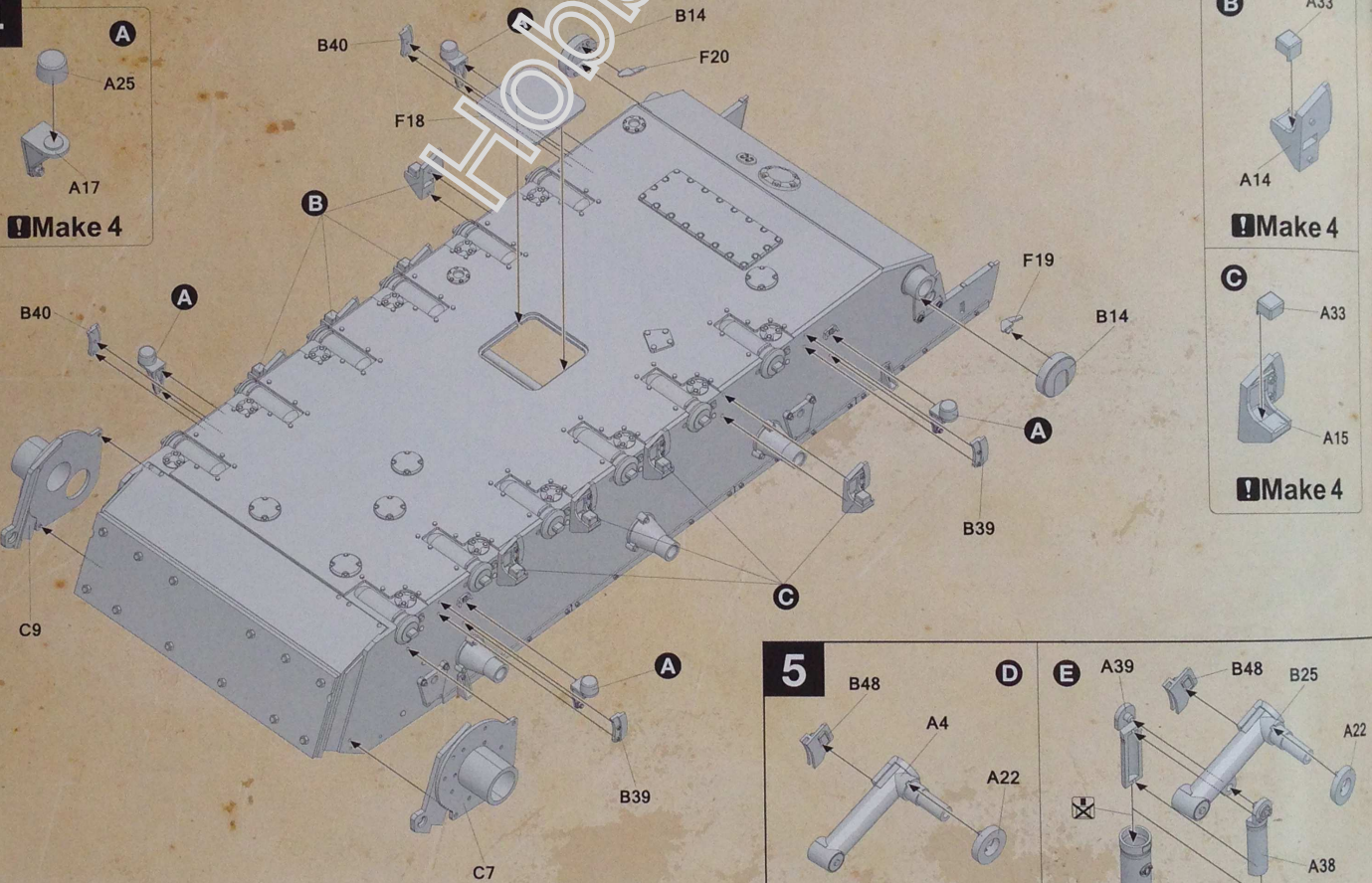

5

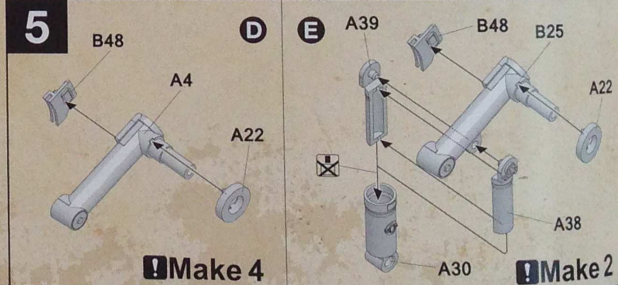

5



6

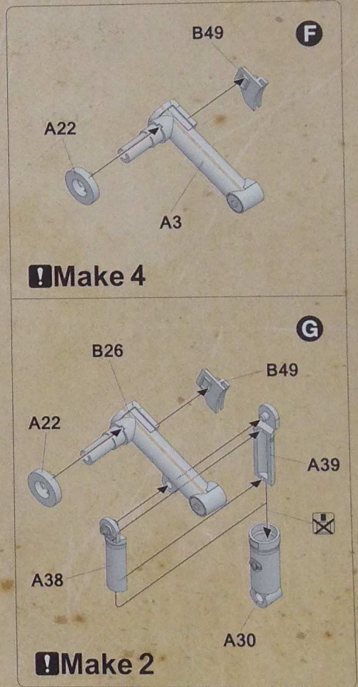
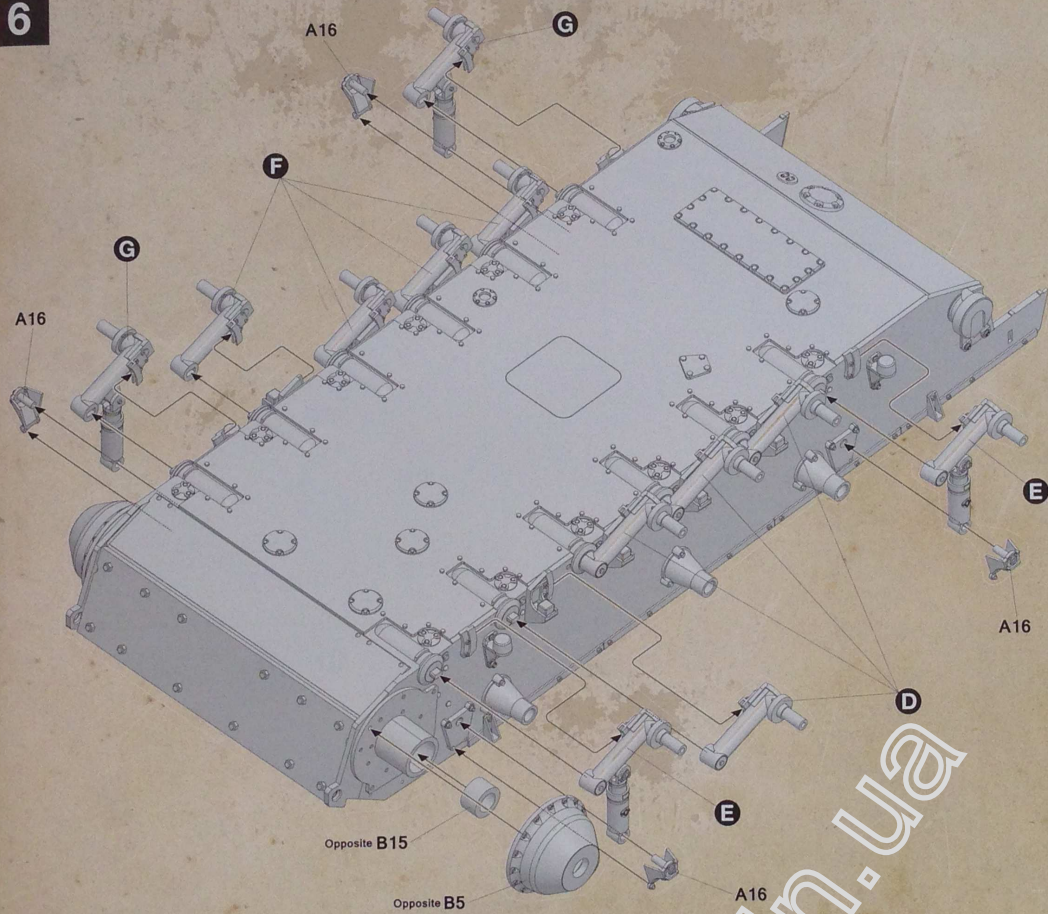

6

7

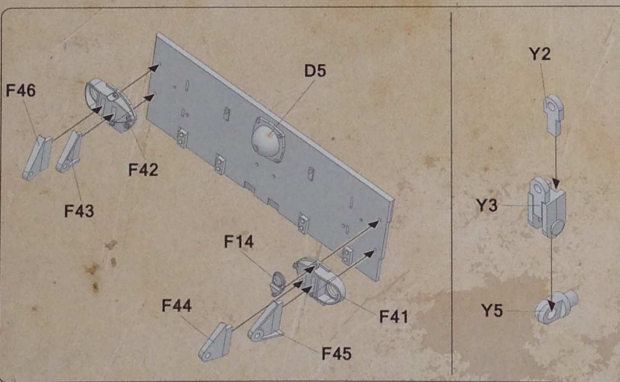
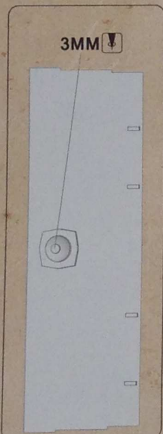
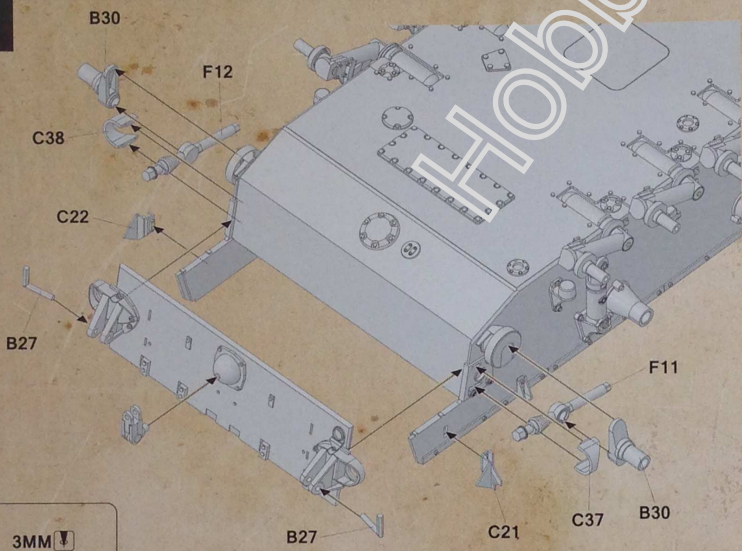

7

8

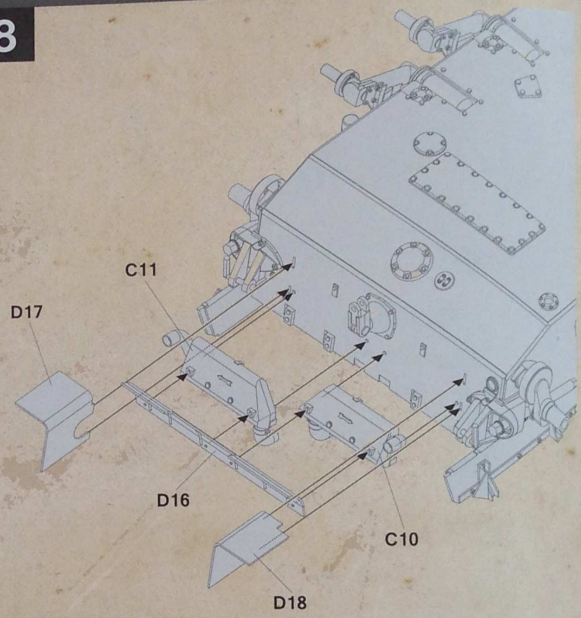

9

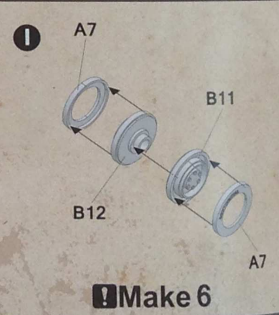
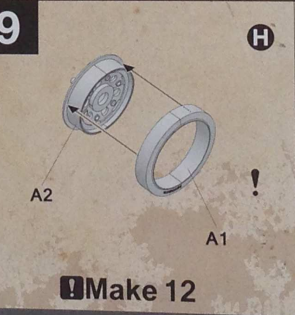

9



10

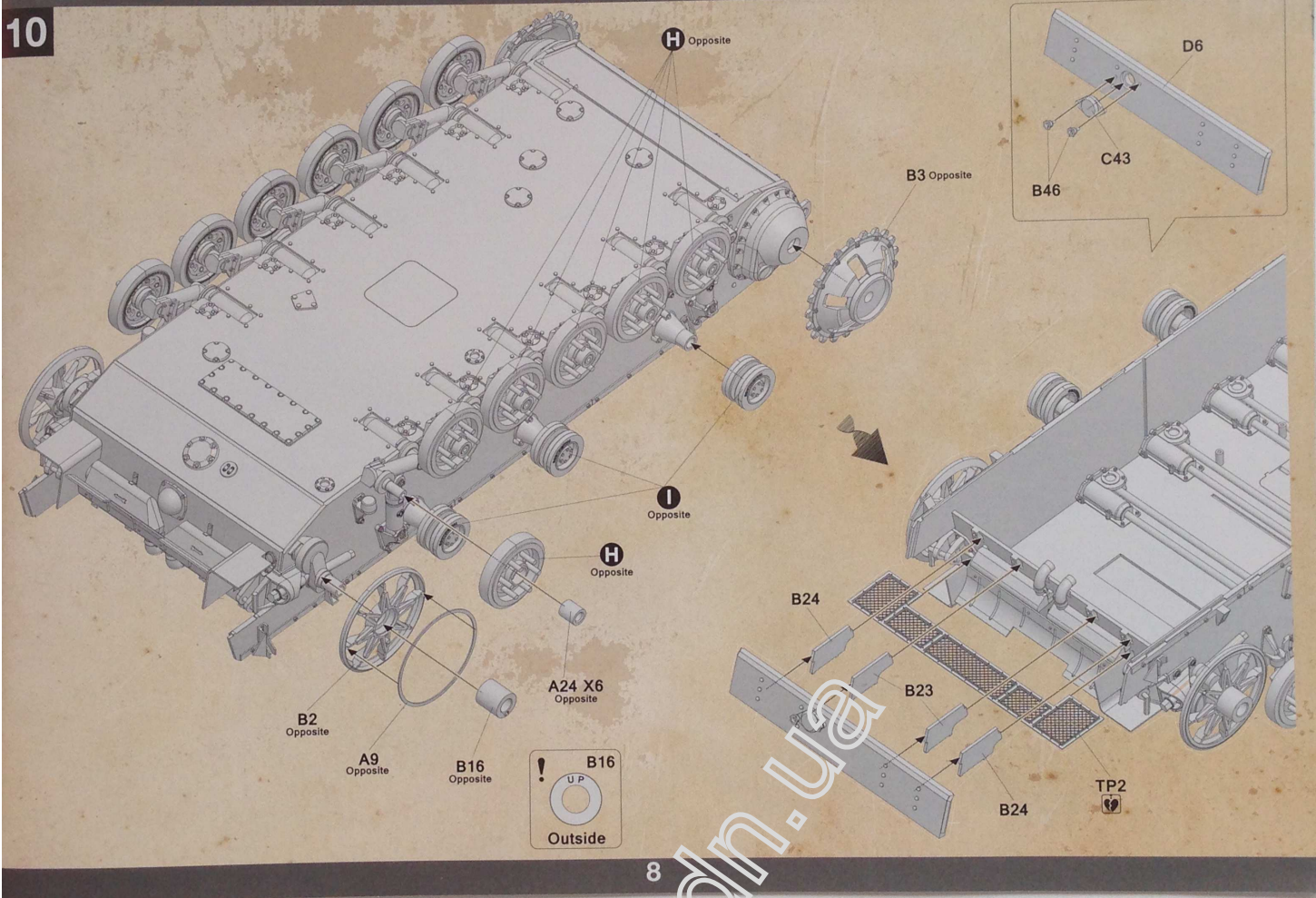

8

11 for left side

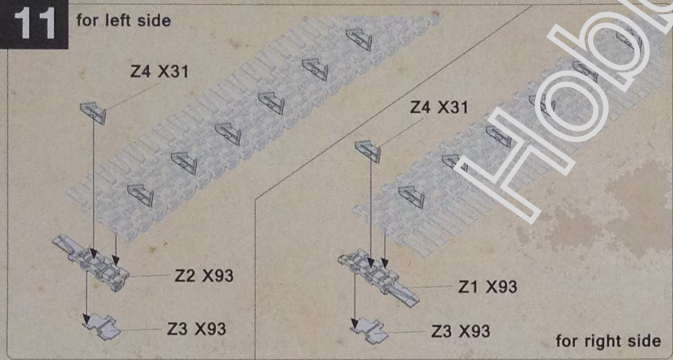

12

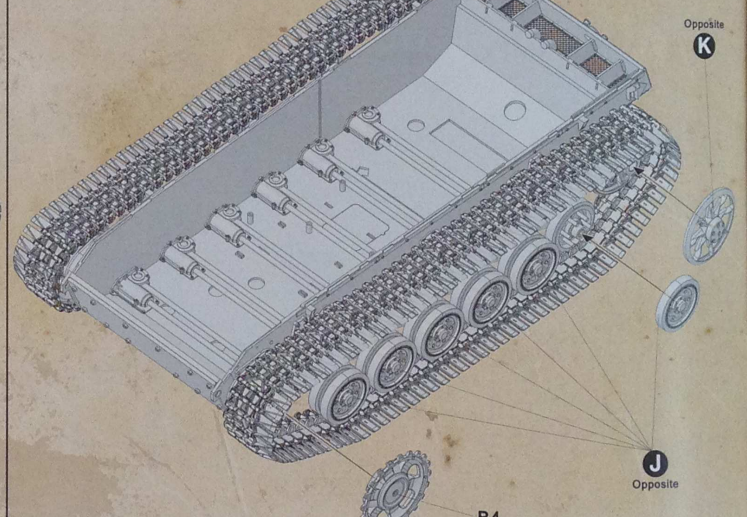
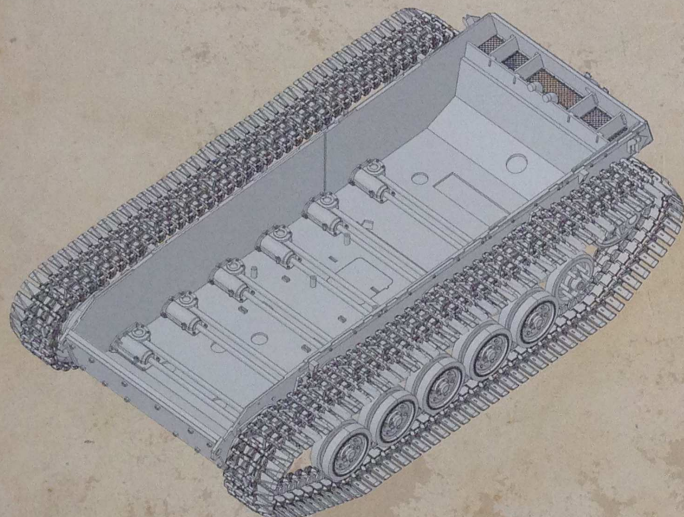
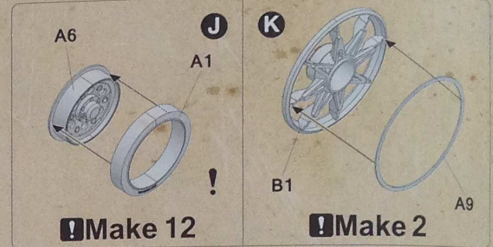

9



13

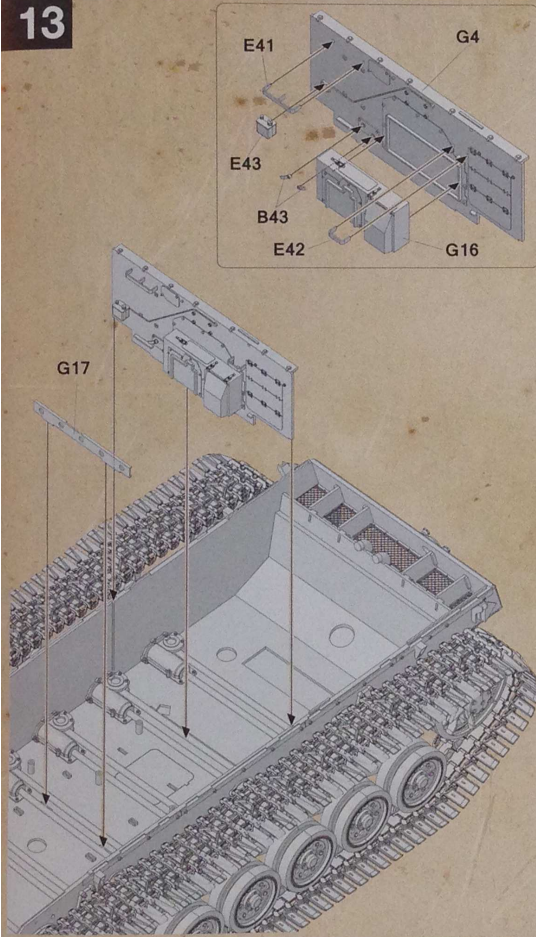

14

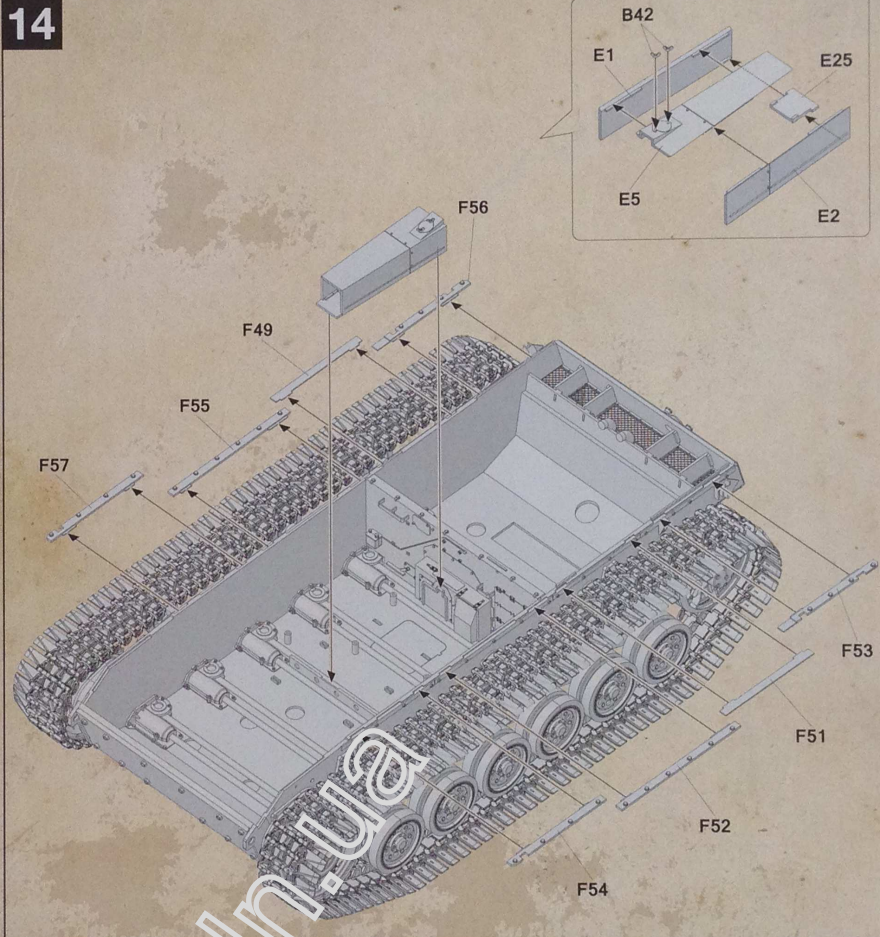

10

15

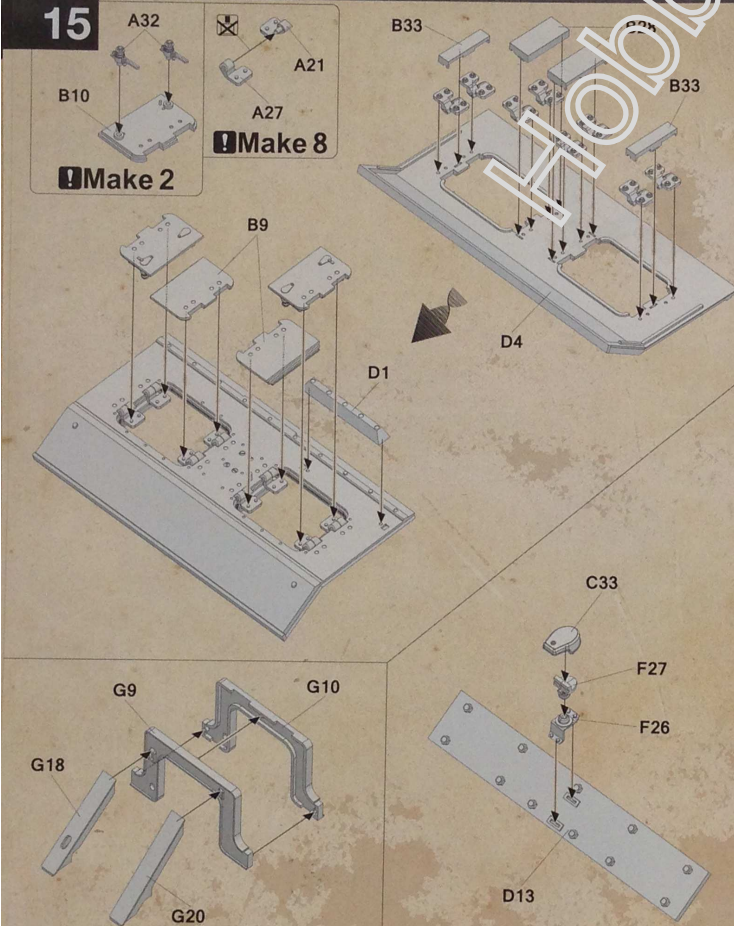

16

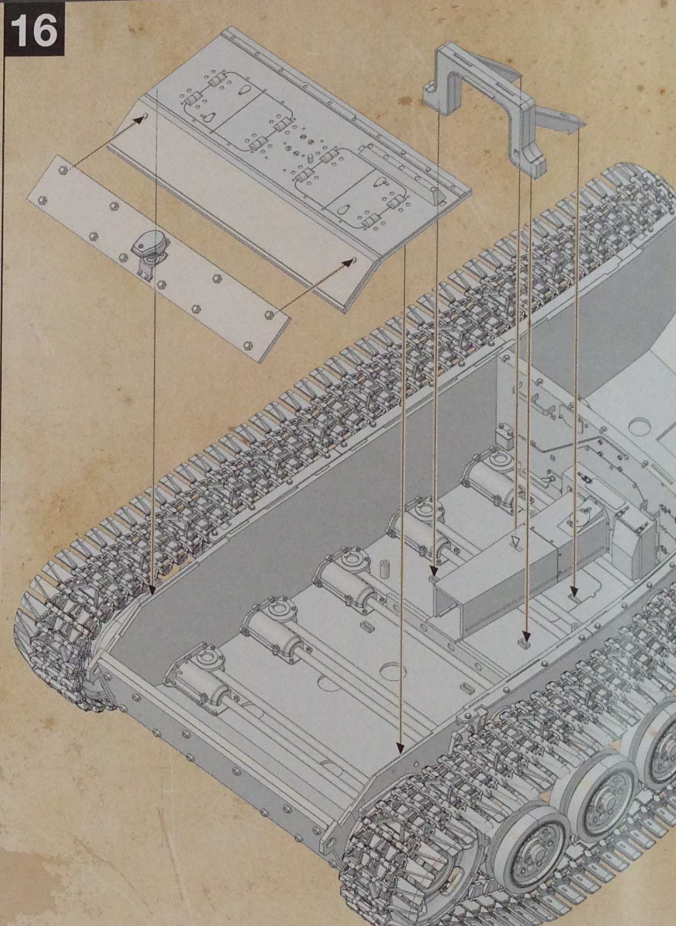

11



17

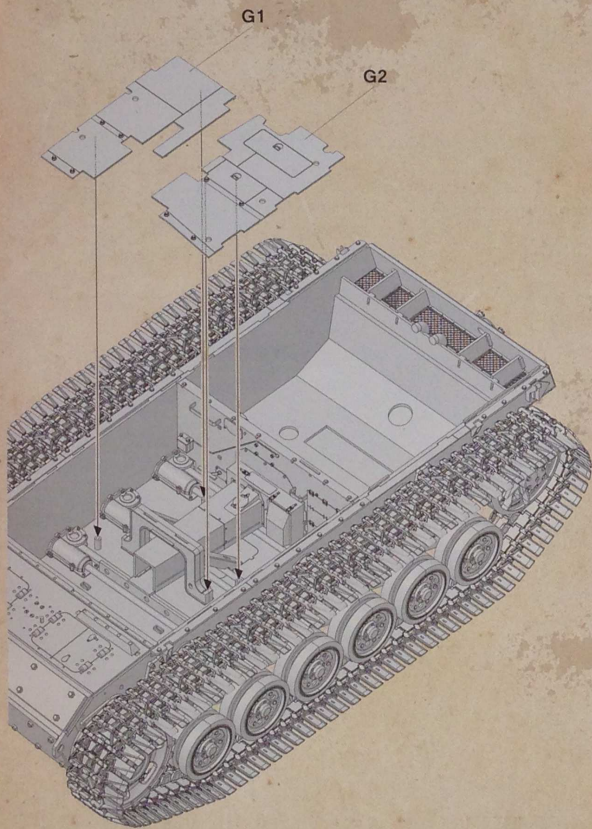

18

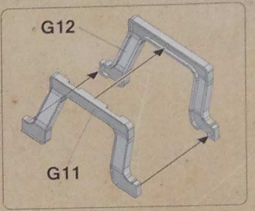
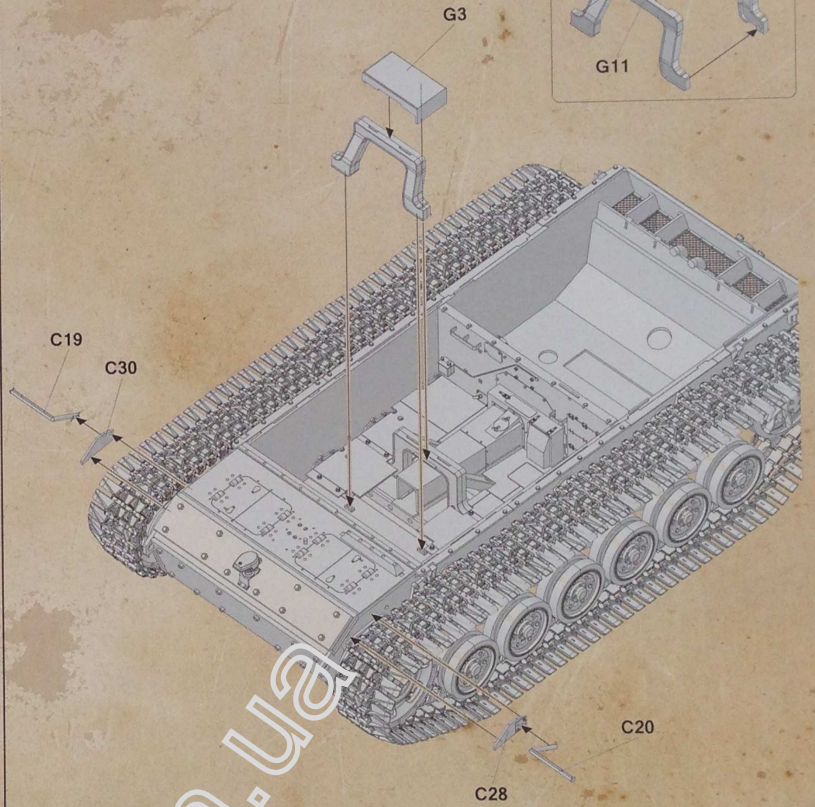

12

19



13







27

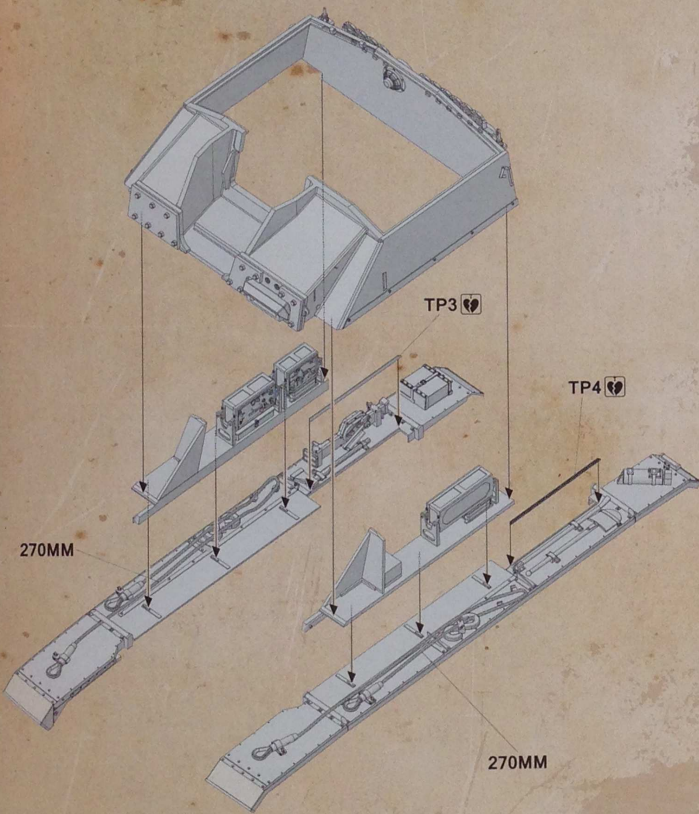

28

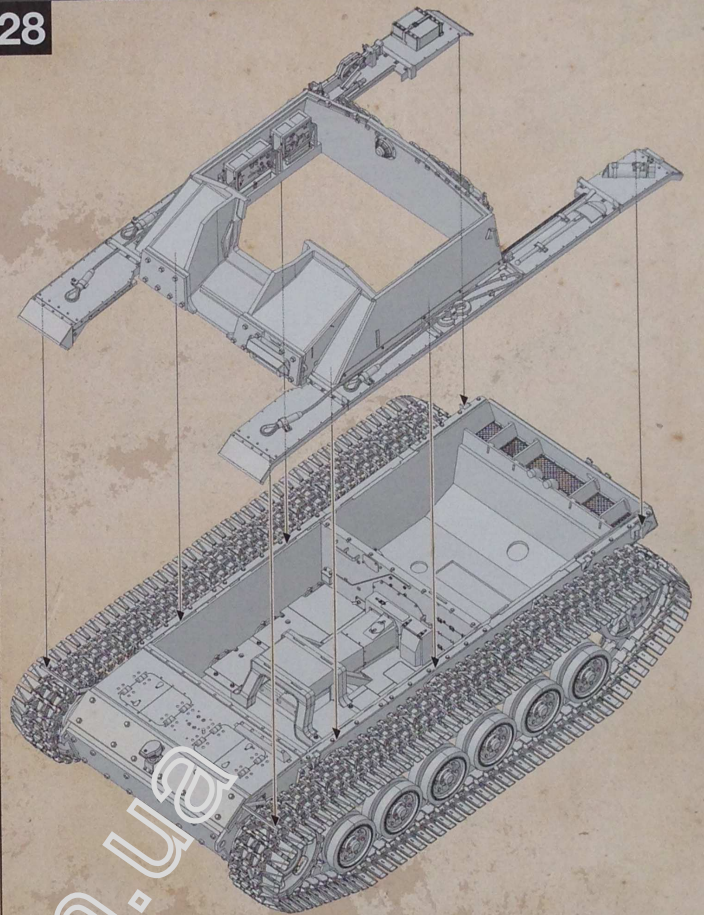

16

29

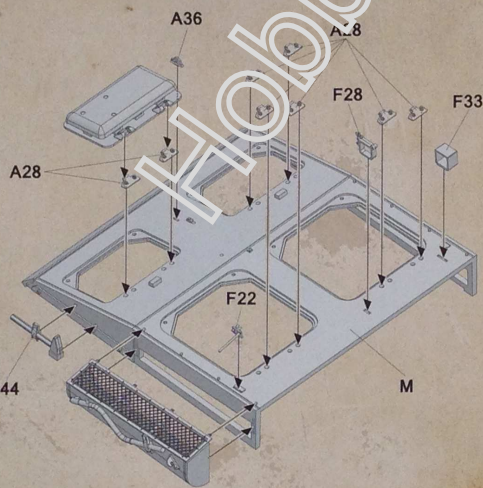
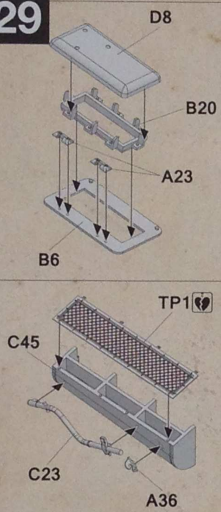

31

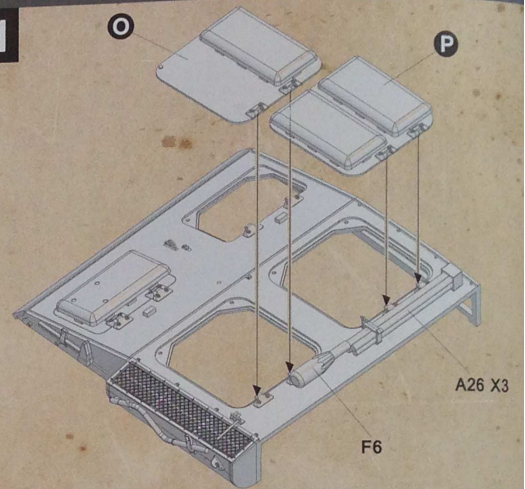

30

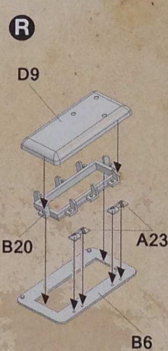
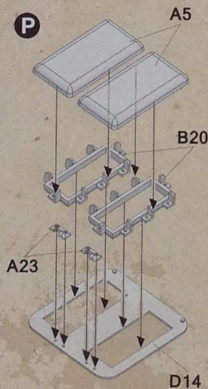
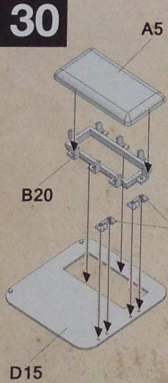

32

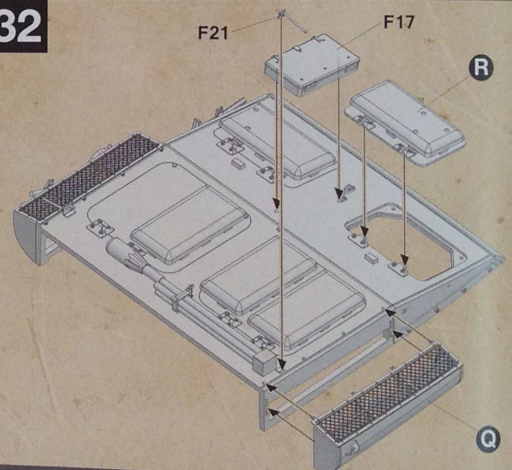

17



33

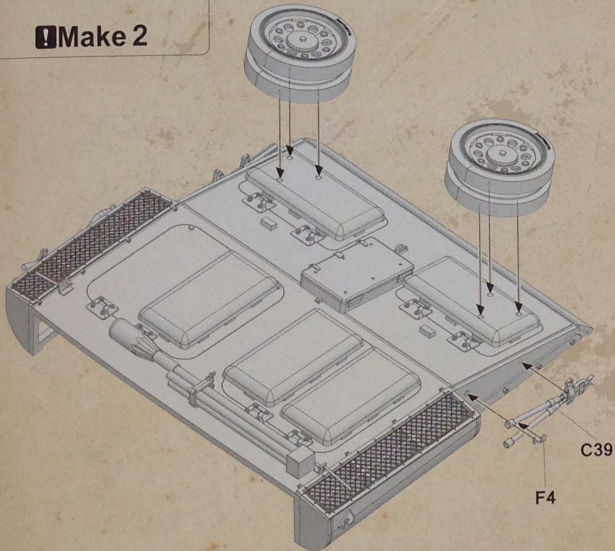
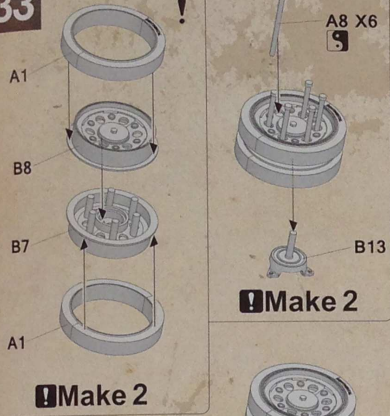

34

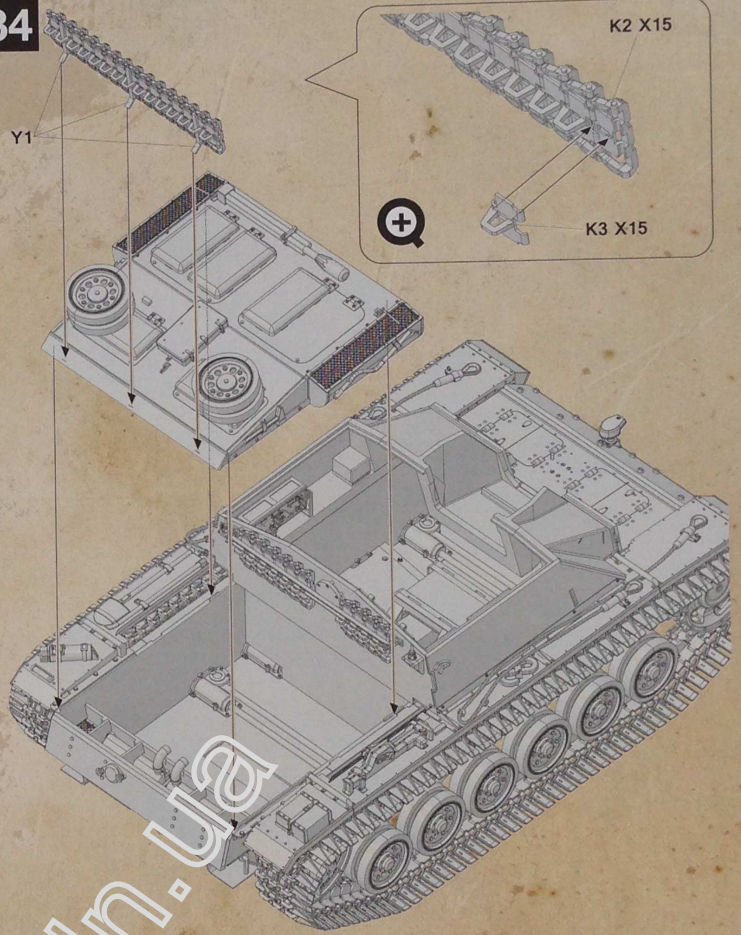

18

35

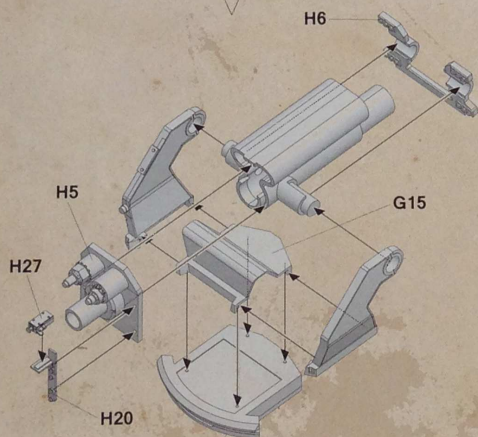
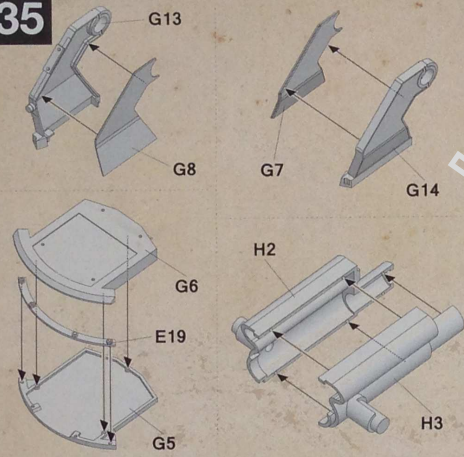

36

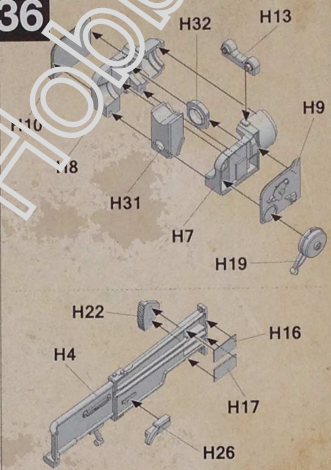

37

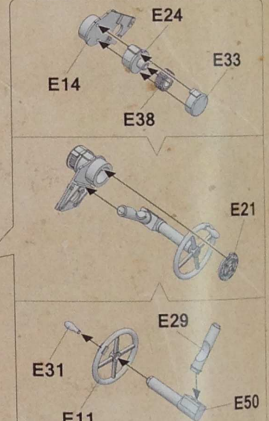
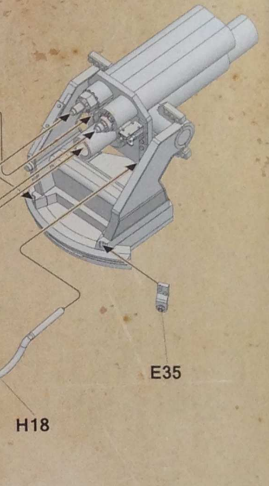
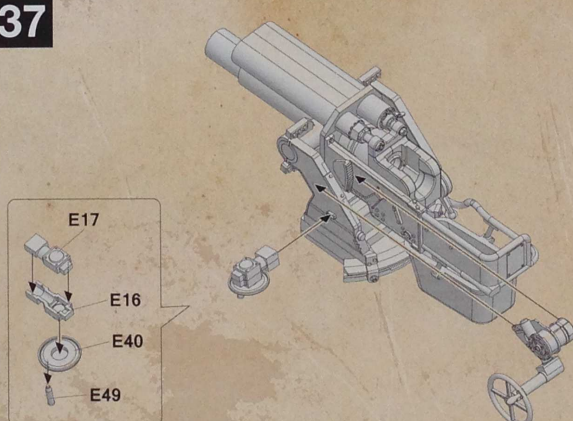

19



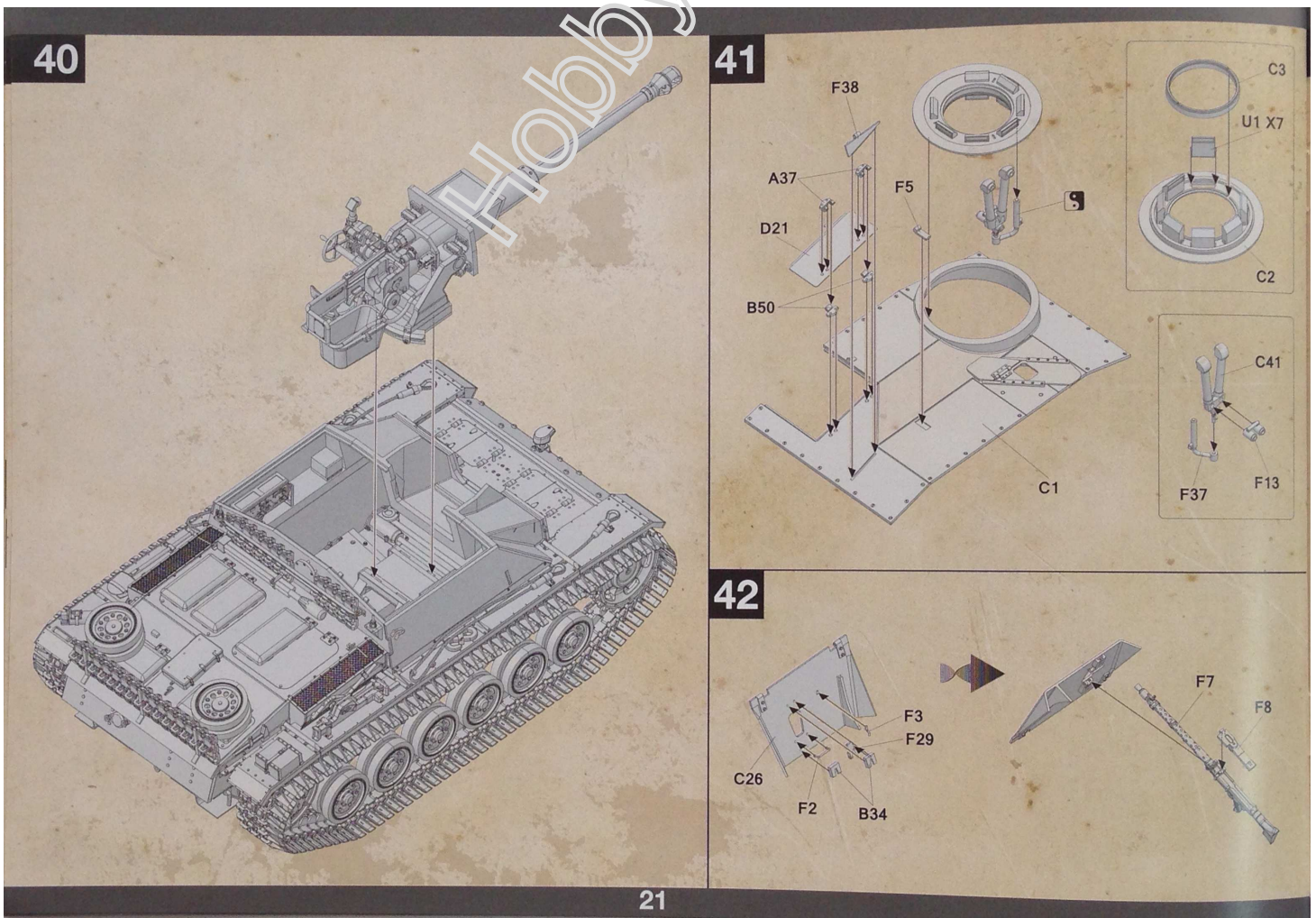
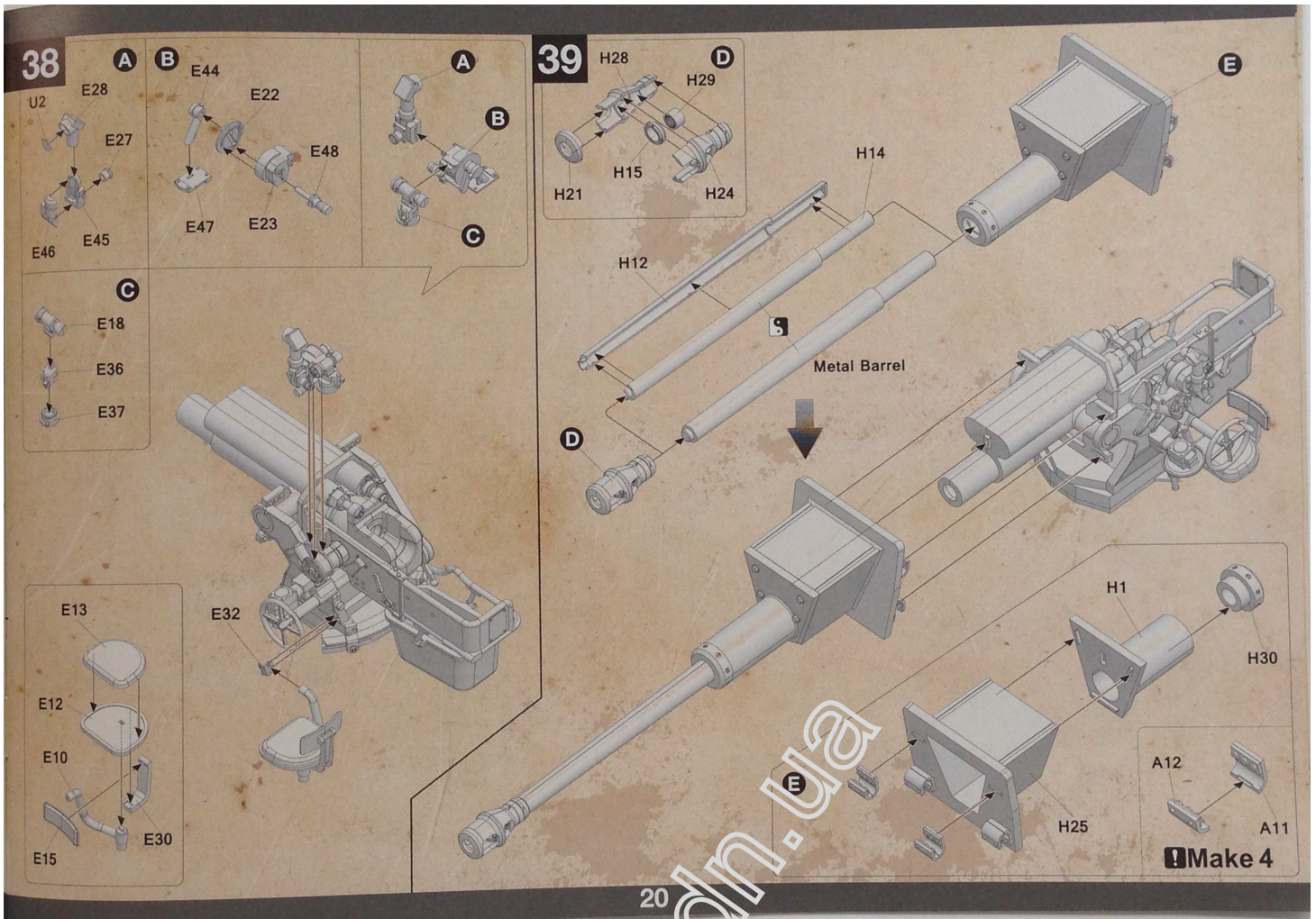



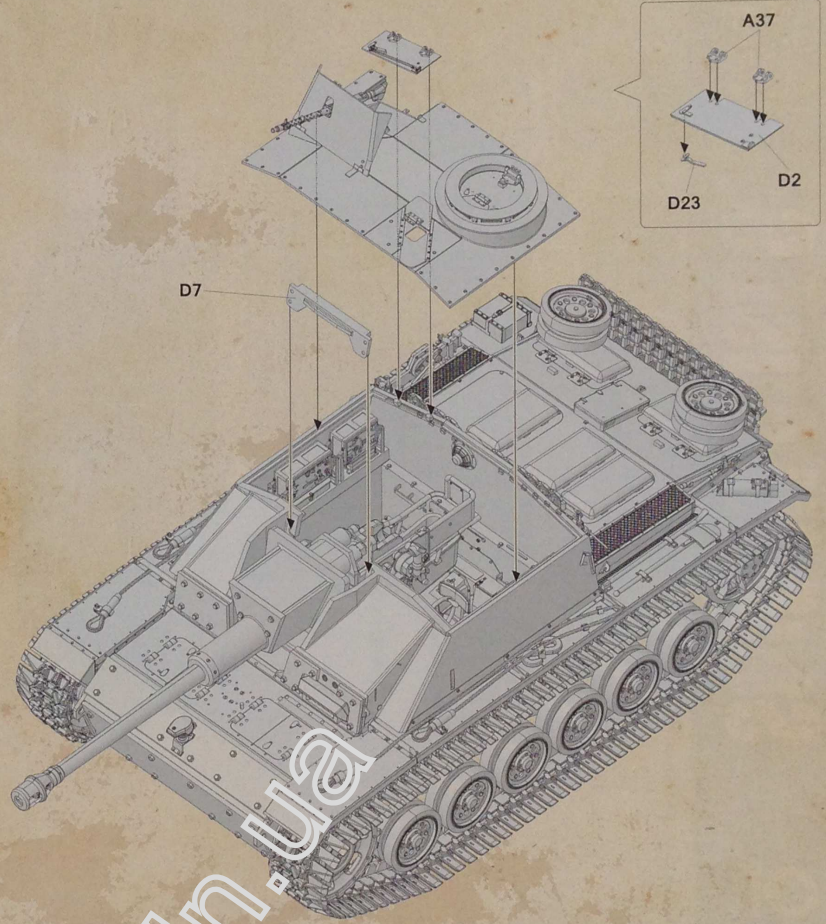
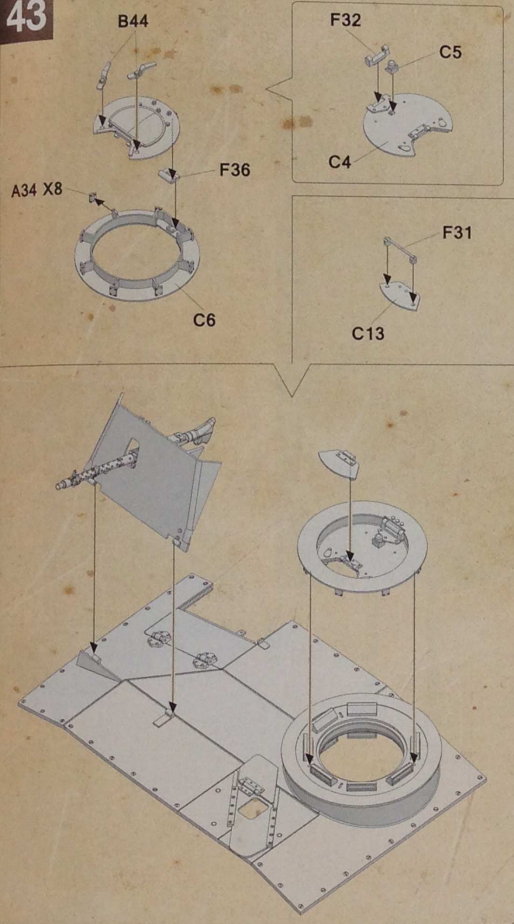

# Stug III Aufg.G



## Painting and Marking Guide

- A.MIG-0005** Dark Treads
- A.MIG-0002** Same Black
- A.MIG-0033** Rubber & Tires
- A.MIG-0035** Gun Metal
- A.MIG-0009** Oak Wood
- A.MIG-0010** Ball 70/70 Dunkelgelb (No War)
- A.MIG-0095** Crystal Periscopes (No War)

Sturmgeschütz-Batterie 742,  
Northern Finland,  
1943

