

Das Werk

DW35022

CANON DE 155 C MODÉLE 1917 SCHNEIDER



— ❁ 1/35 ❁ —

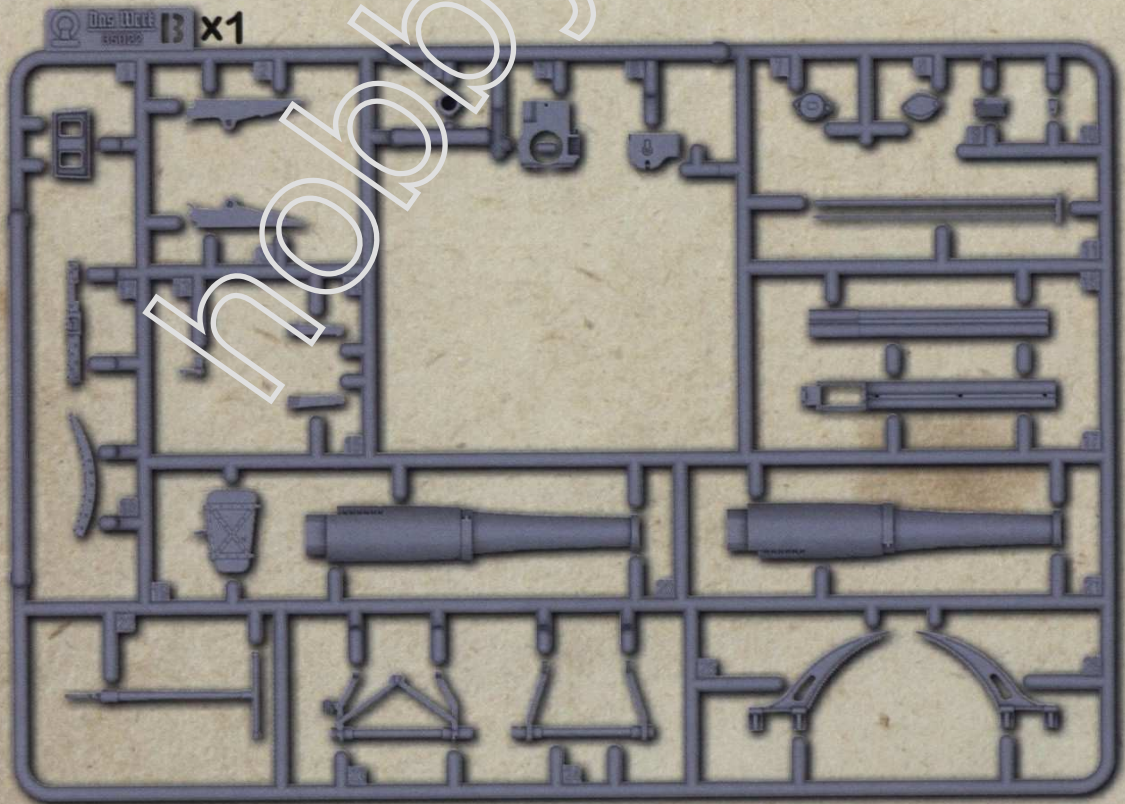
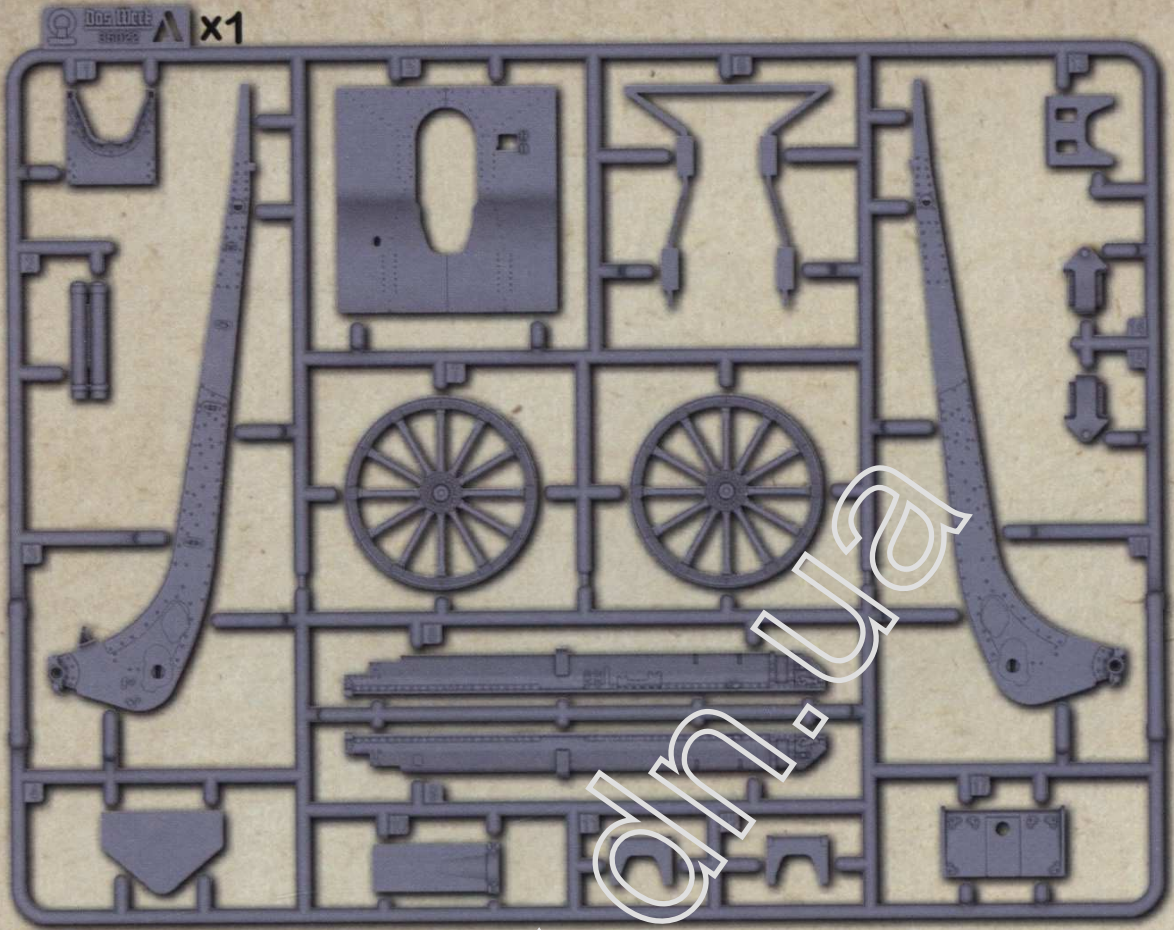

hobby.on.ua

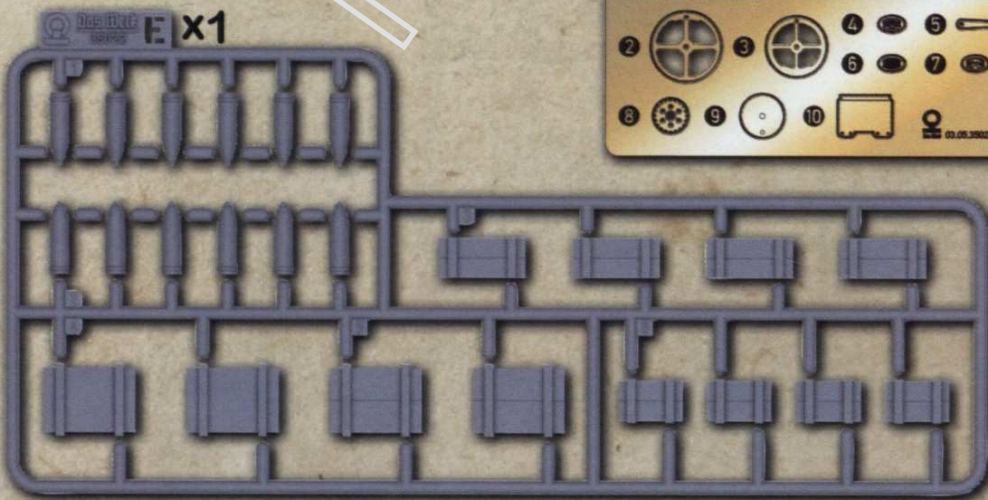
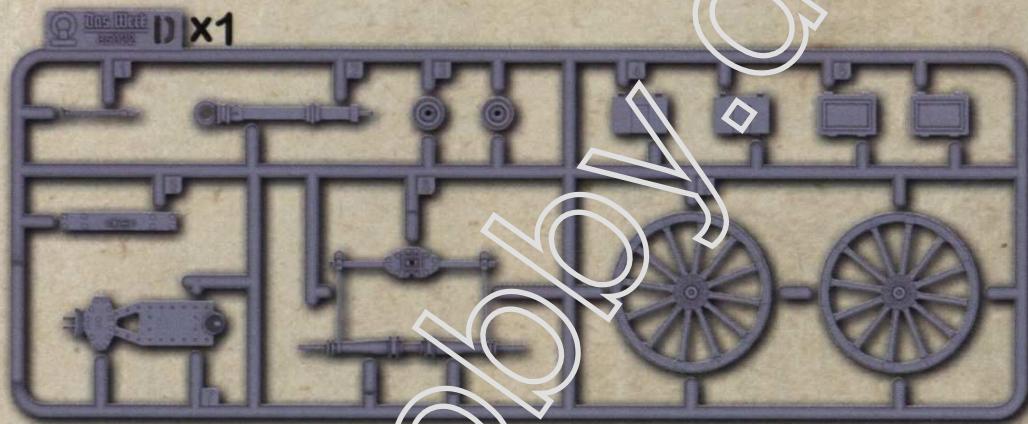
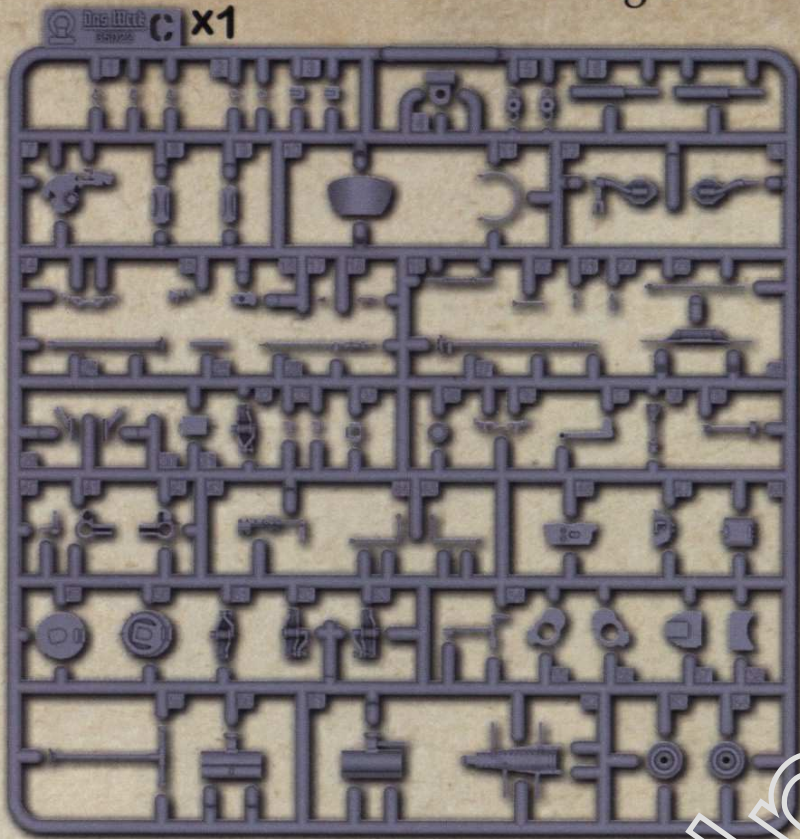

hobbyonline.us

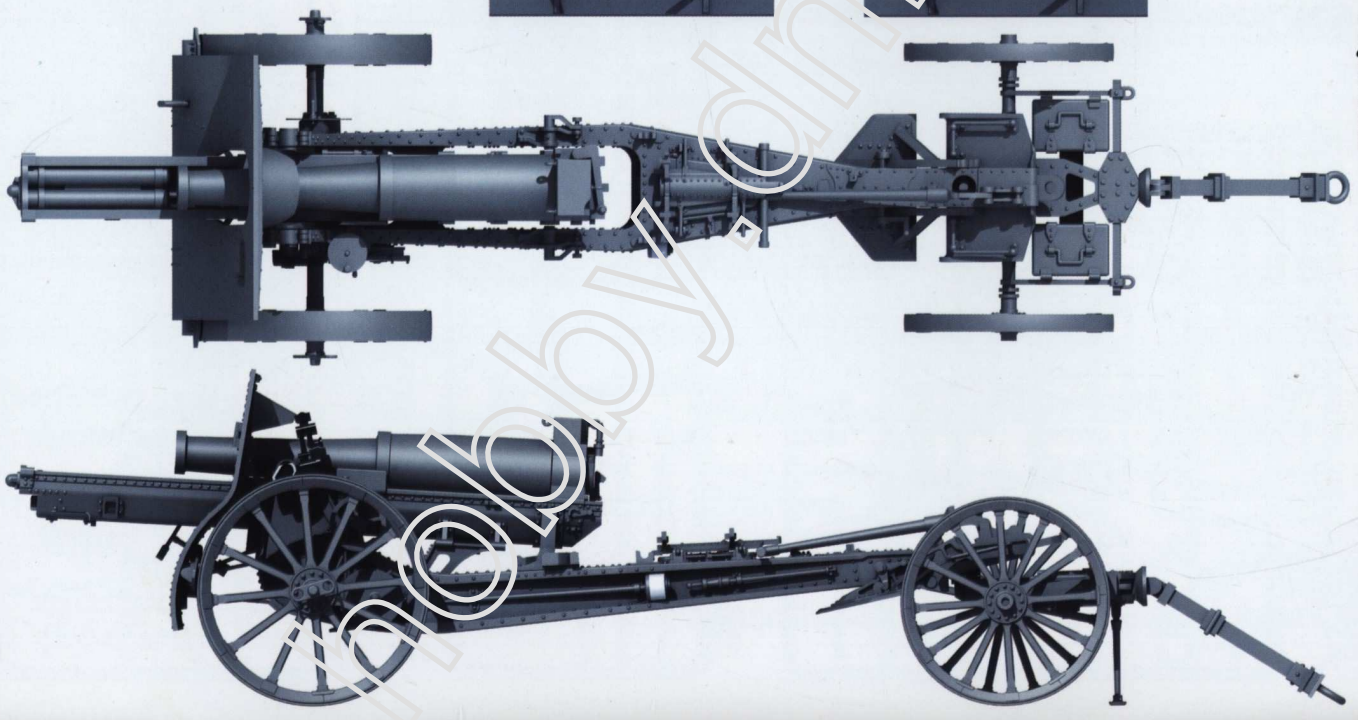
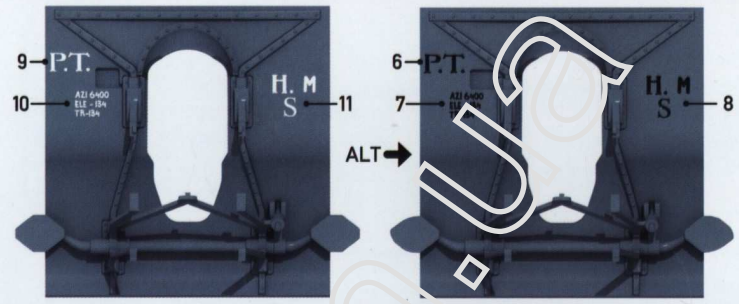

- XF25 TAMIYA
- H61 Mr Hobby H Series
- 062 AMMO of Mig
- 71114 Vallejo
- 87 Humbrol
- MMP061 Mission Models



WORLD WAR I U.S.A.

"Calamity Jane" of Battery E, 11th Field Artillery, fired the last artillery round of World War I at 1100 hrs, 11 November 1918



- | | | | |
|---|---|---|-------------------|
|  |  |  | |
| XF62 | XF52 | XF60 | TAMIYA |
| H52 | H37 | H071 | Mr Hobby H Series |
| 926 | 064 | 130 | AMMO of Mig |
| 71316 | 71136 | 71031 | Vallejo |
| 86 | 113 | 74 | Humbrol |
| MMP024 | MMP033 | MMP011 | Mission Models |





- XF73 TAMIYA
- H421 Mr Hobby H Series
- 031 AMMO of Mig
- 71341 Vallejo
- 102 Humbrol
- MMP030 Mission Models

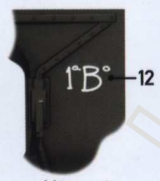
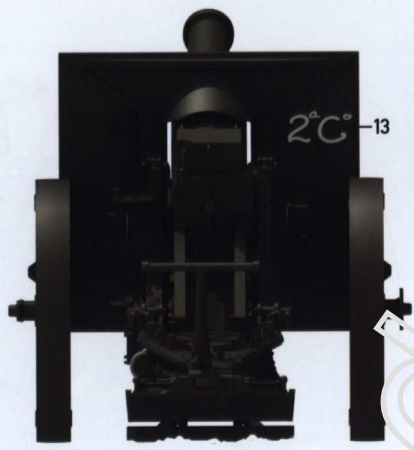

Alternate markings 2

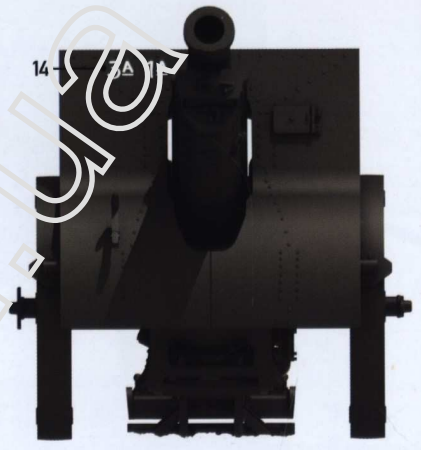

Alternate markings 1



SPANISH CIVIL WAR 1936-1939

WORLD WAR II GERMANY - AFRICA



- XF92 - TAMIYA
- H79 Mr Hobby H Series
- 012 AMMO of Mig
- 71122 Vallejo
- 74 Humbrol
- 011 Mission Models

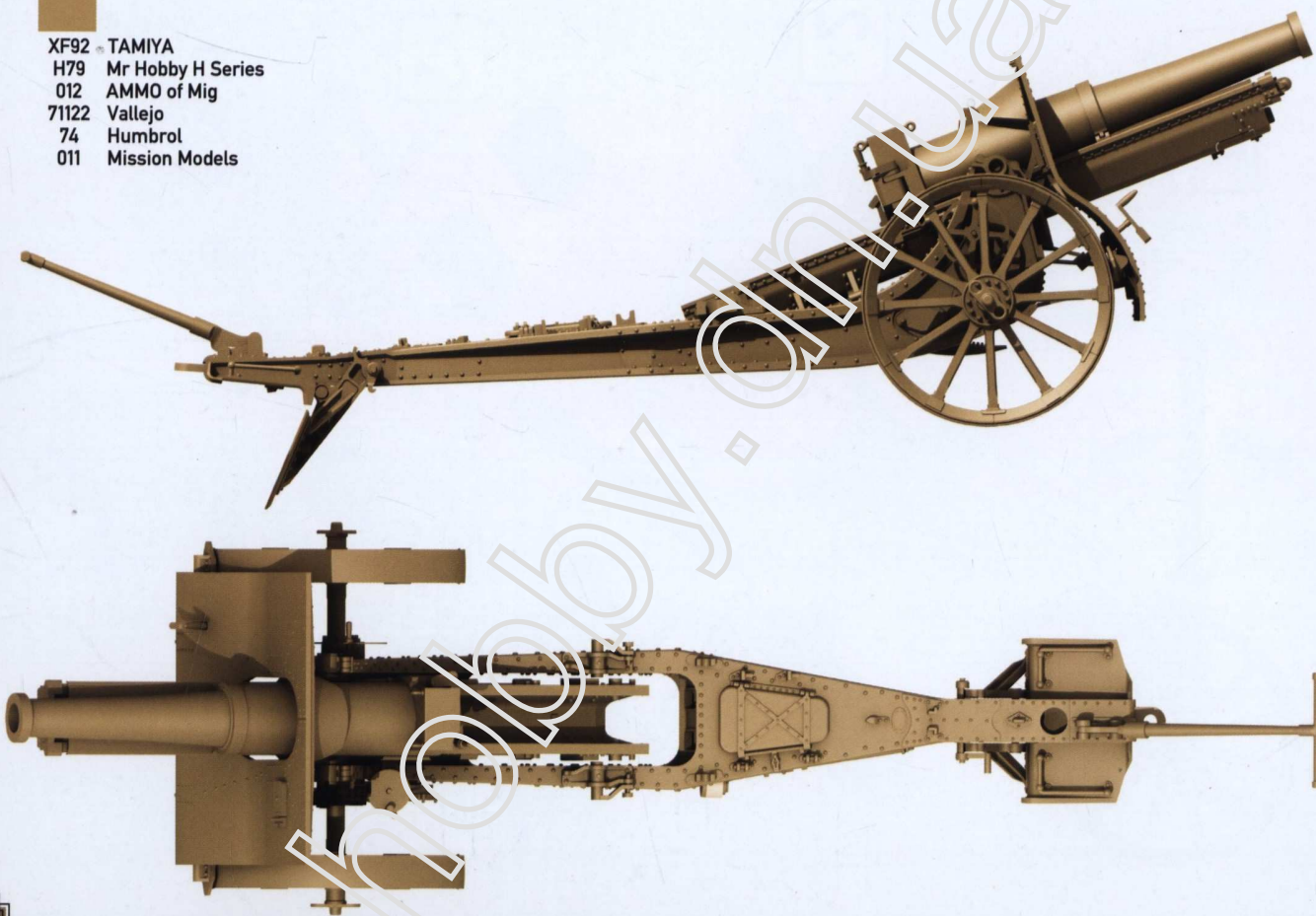

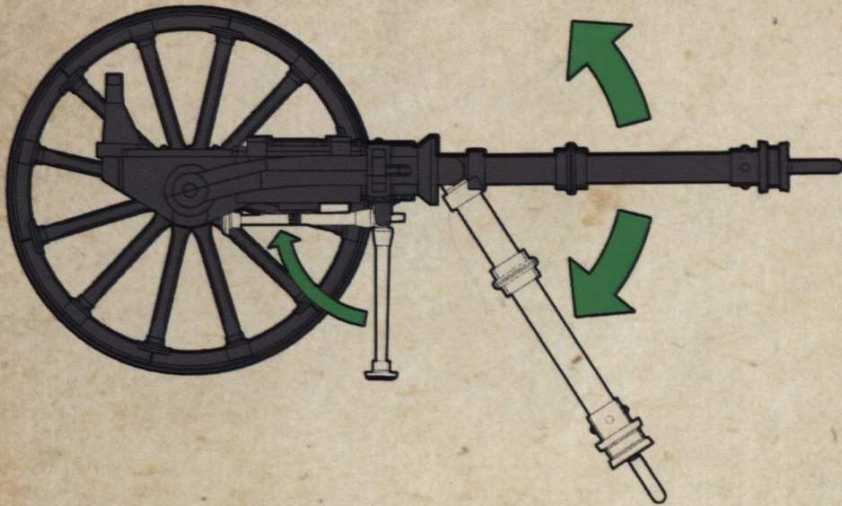

ATTENTION!
ADD YOKE AND
BOTTOM STAND
IN DESIRED
POSITION AFTER
PLACING LIMBER IN
SCENE

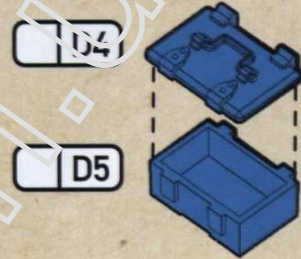
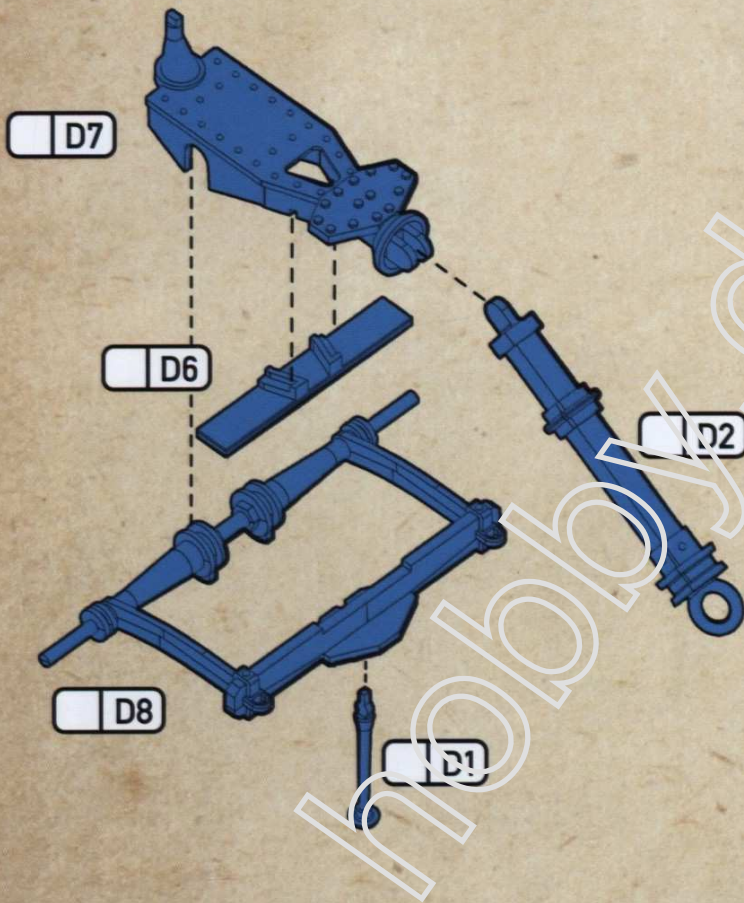

x 2
REPEAT

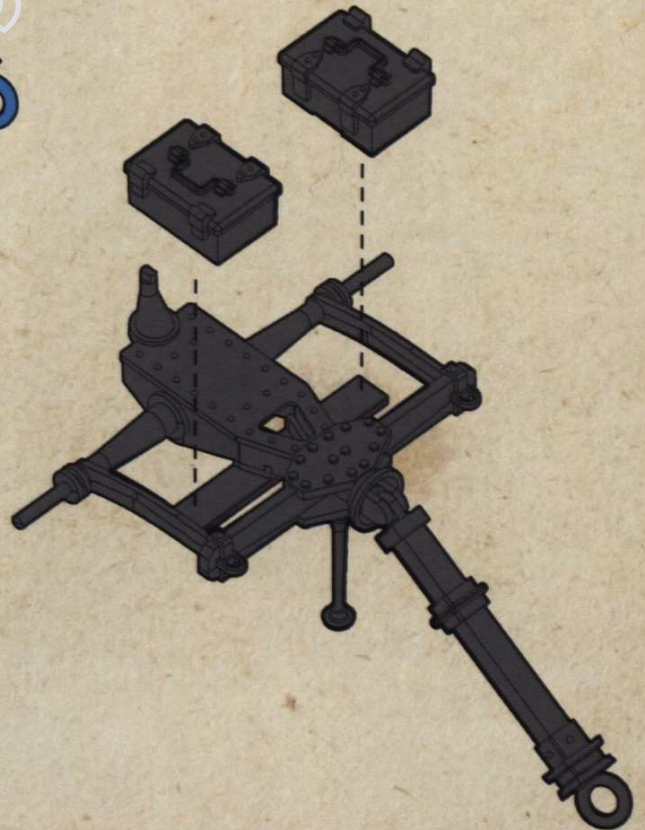

See the last step (Pg 27) for adding the
limber to the finished model.

x 2
REPEAT

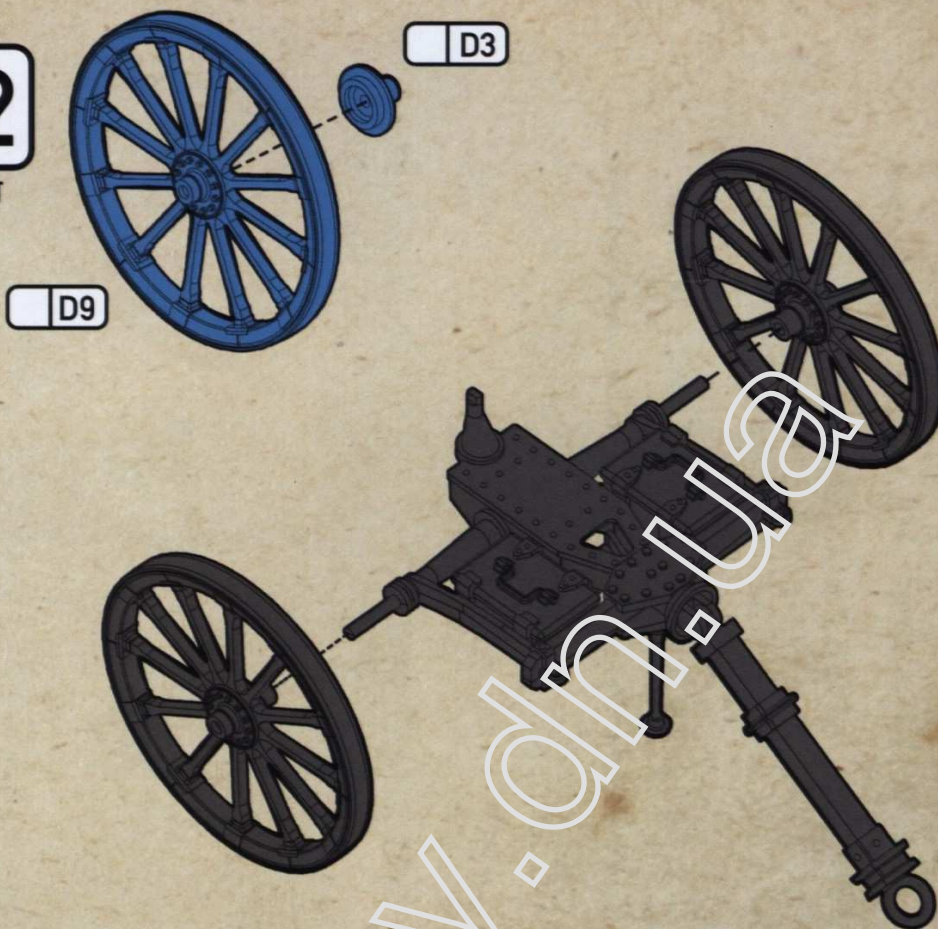

x 2
REPEAT

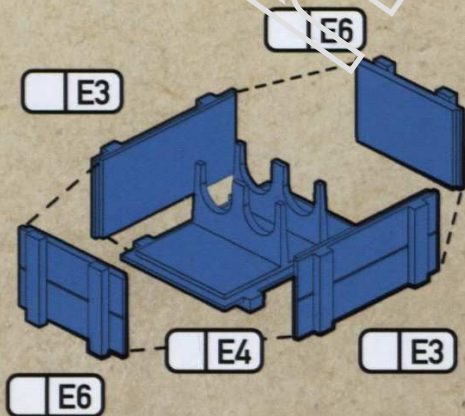

-CRATE LIDS CAN BE LEFT OFF.
-SHELLS CAN BE DISPLAYED OUTSIDE OF CRATE

2 TYPES OF SHELL
ARE INCLUDED
(colors are speculation)



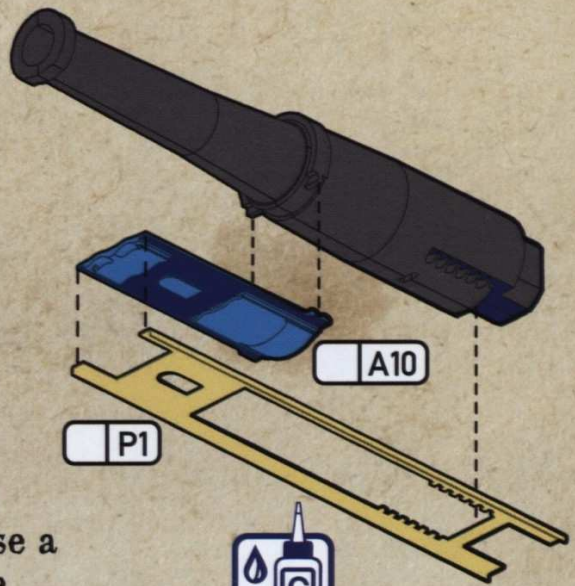
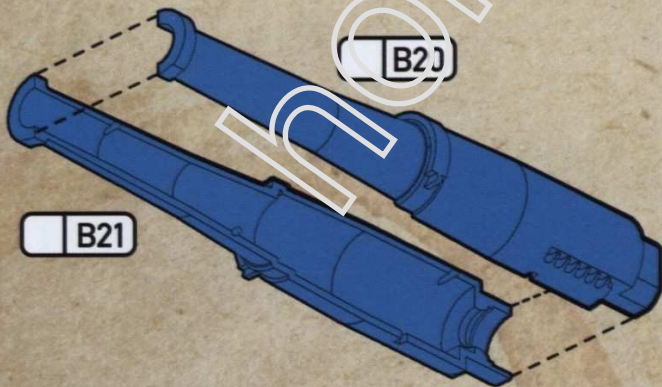
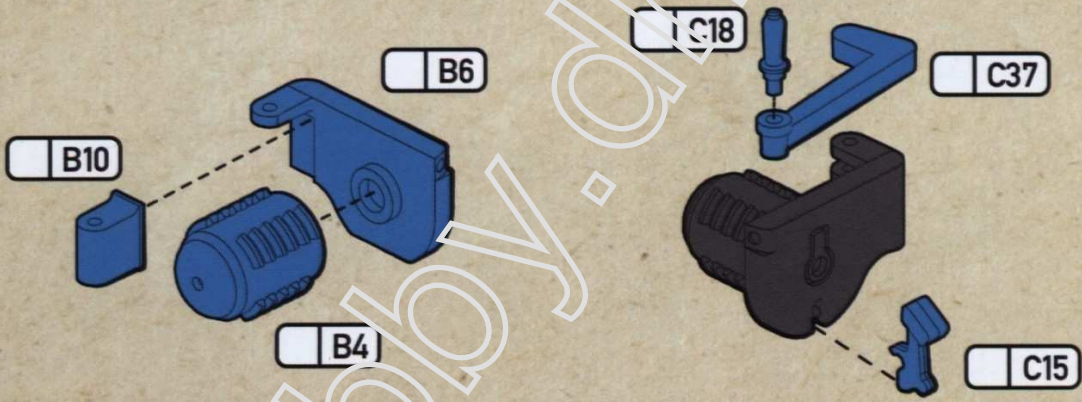
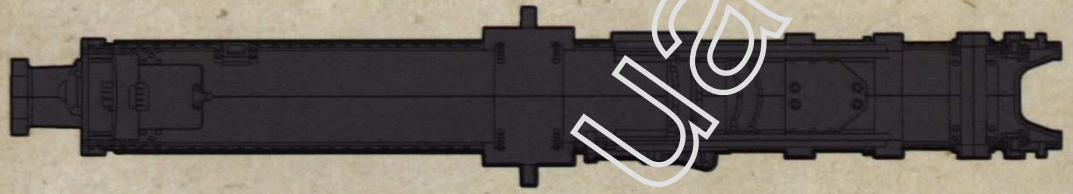
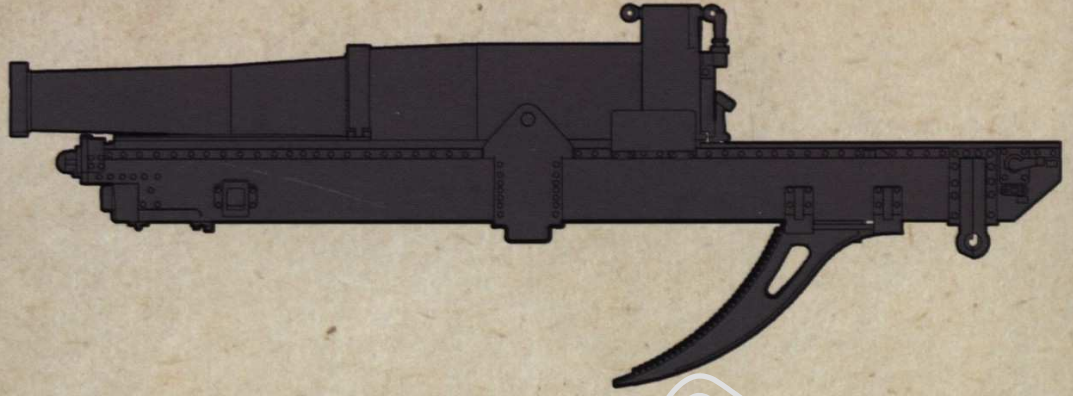

ANNEAL

Anneal part first. Work slowly, use a photoetch bending tool if possible

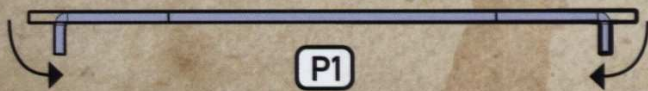

P1



USE CA
GLUE



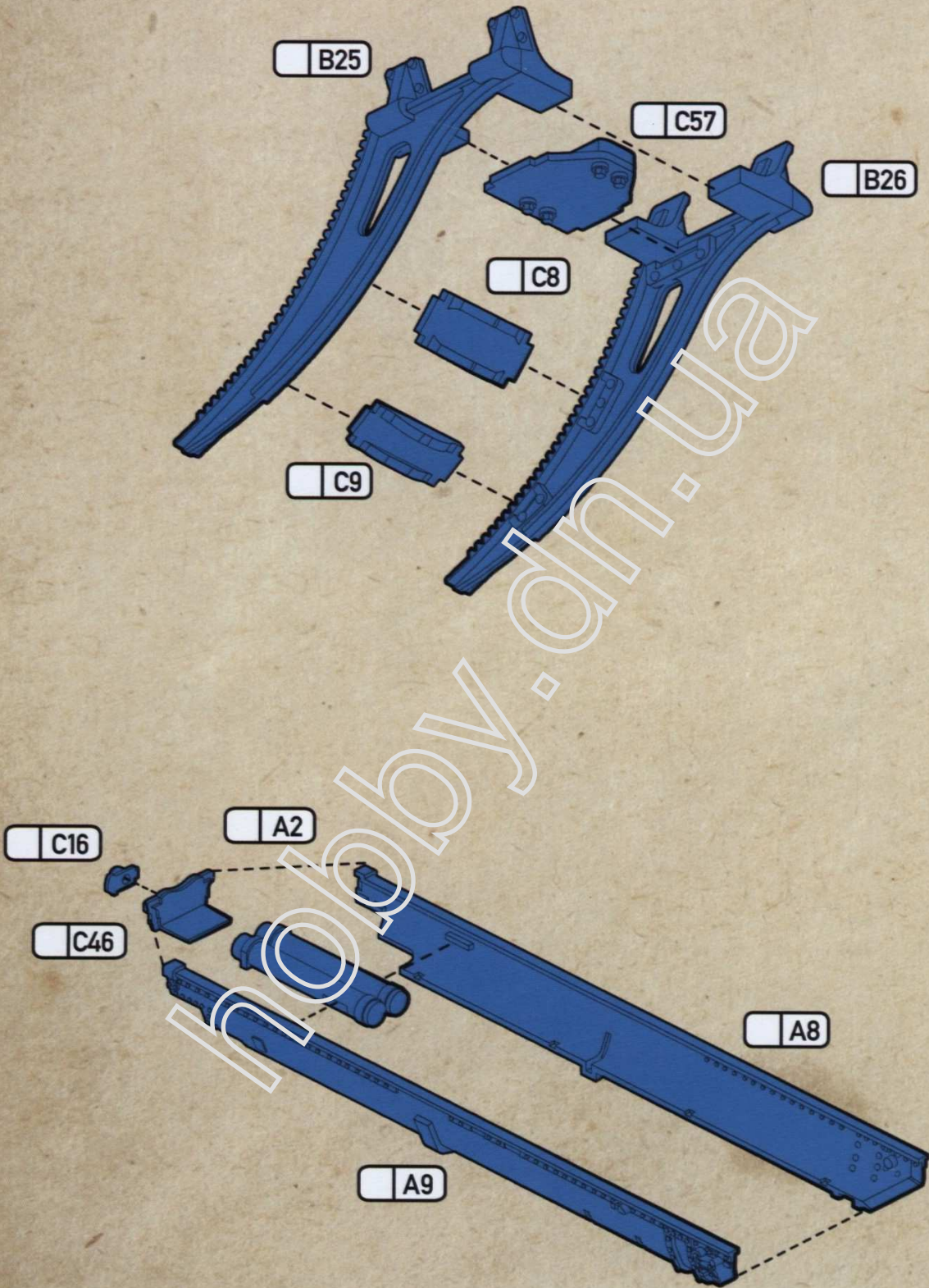

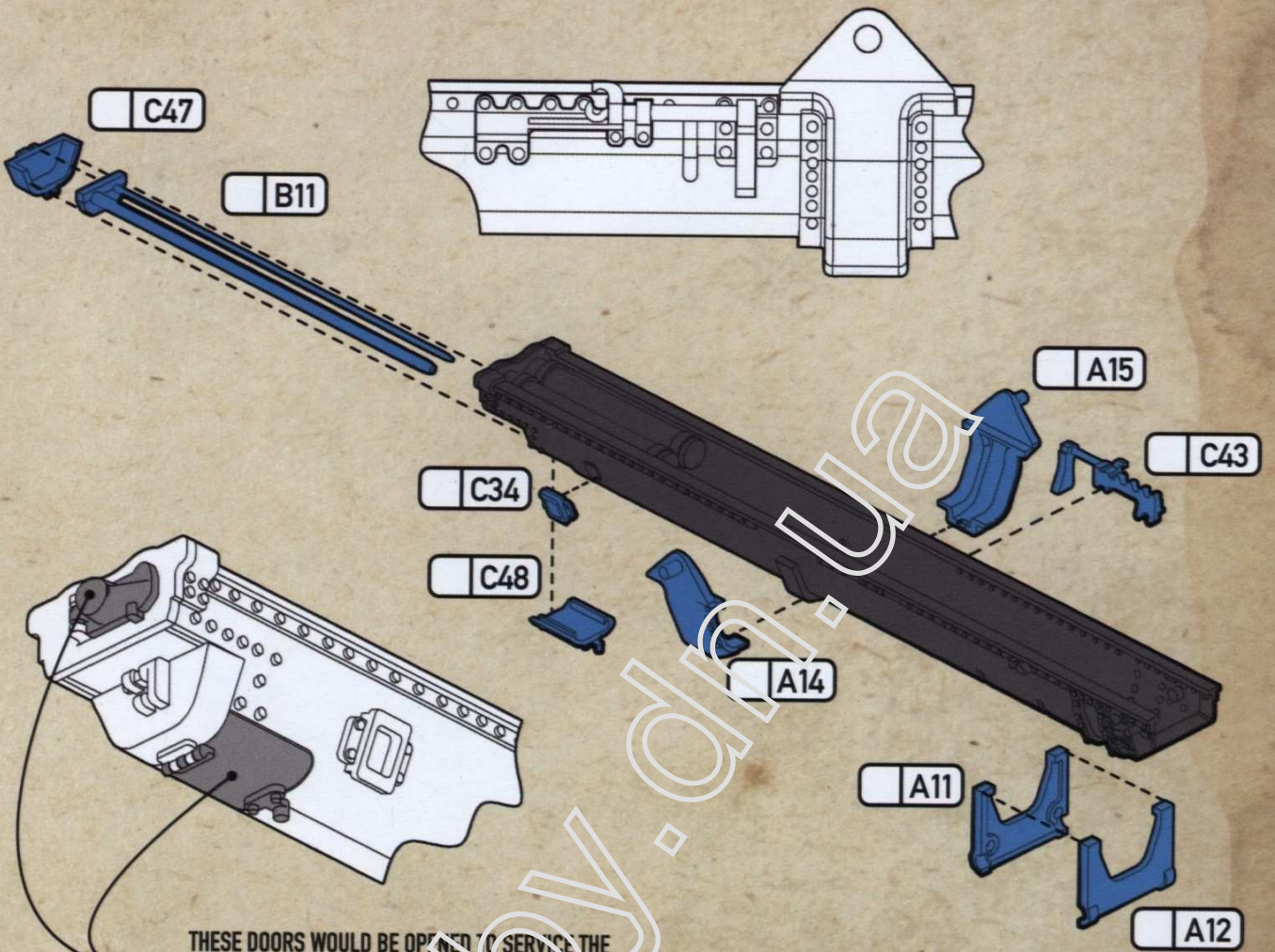

THESE DOORS WOULD BE OPENED TO SERVICE THE HYDRAULIC RECOIL CYLINDERS DURING USE AND MAINTENANCE

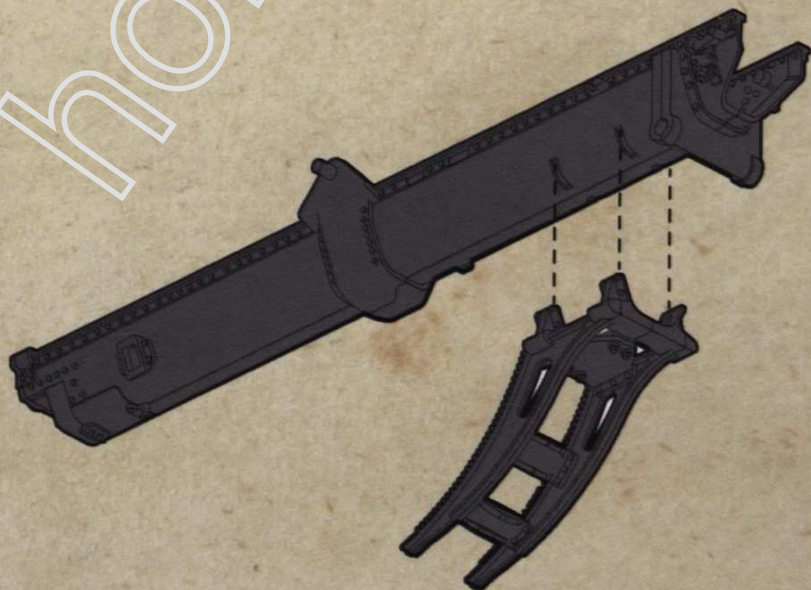

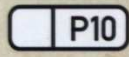

USE CA GLUE

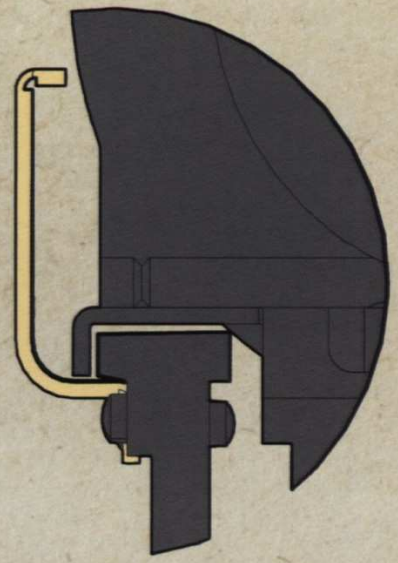
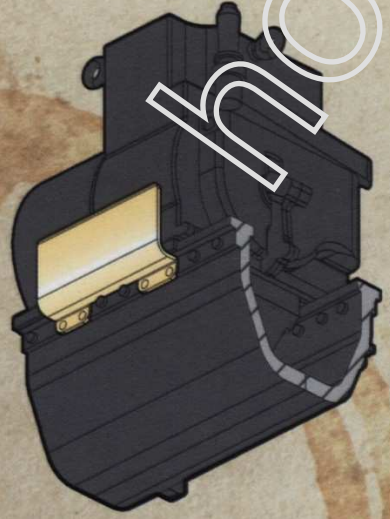
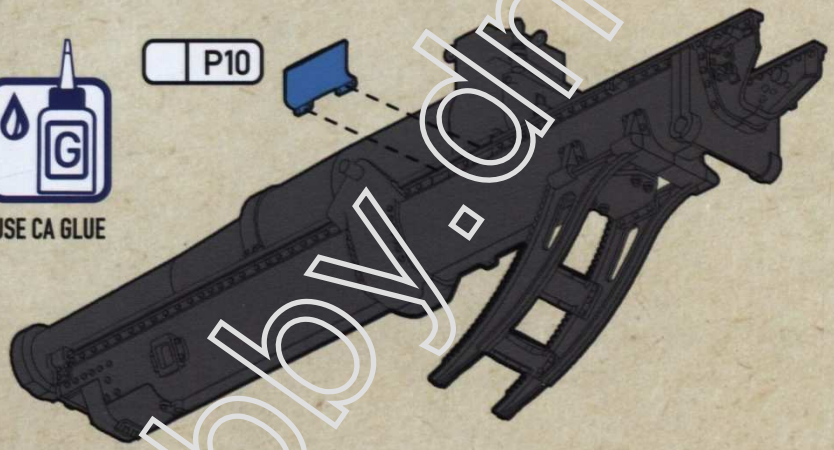
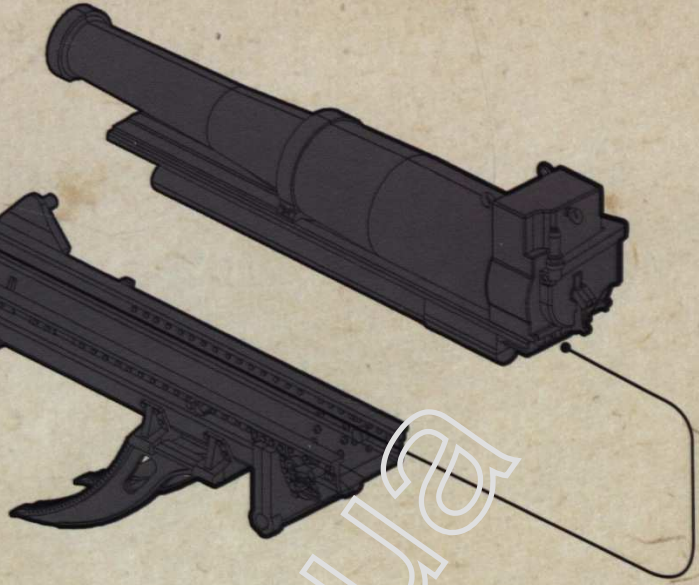

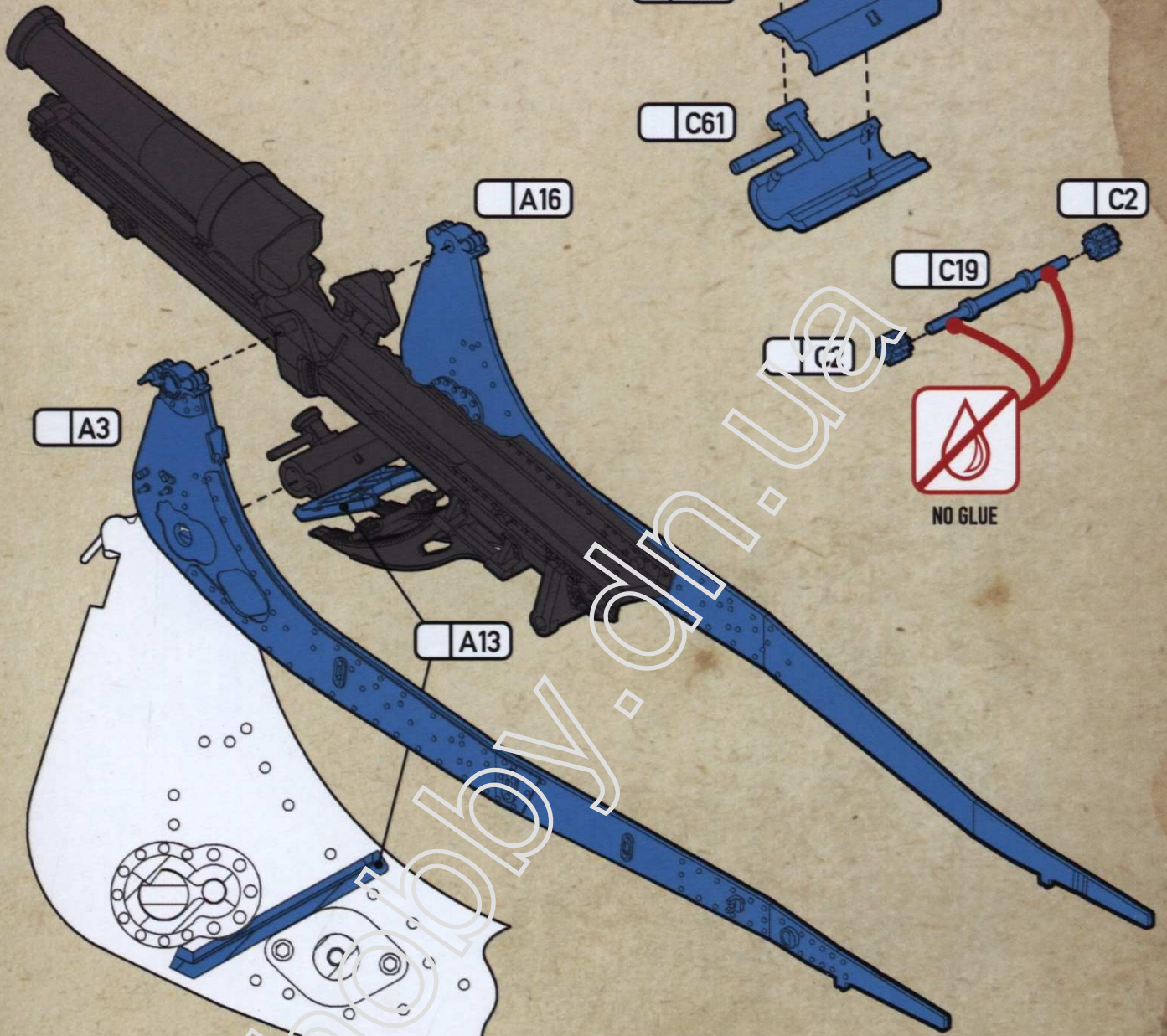

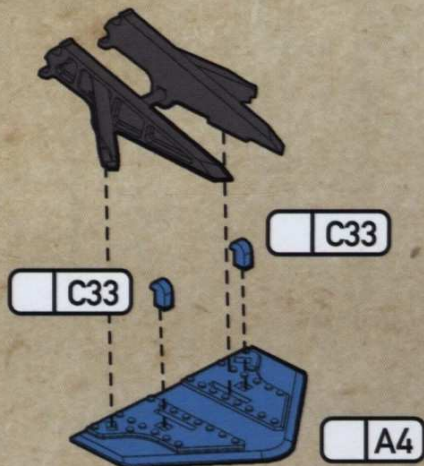
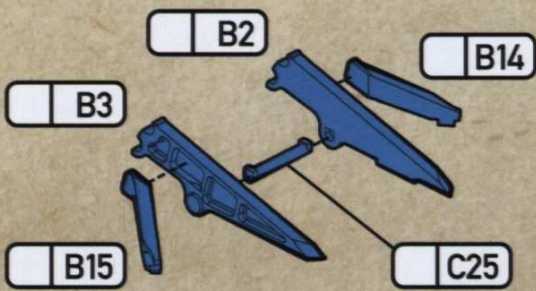

NO GLUE

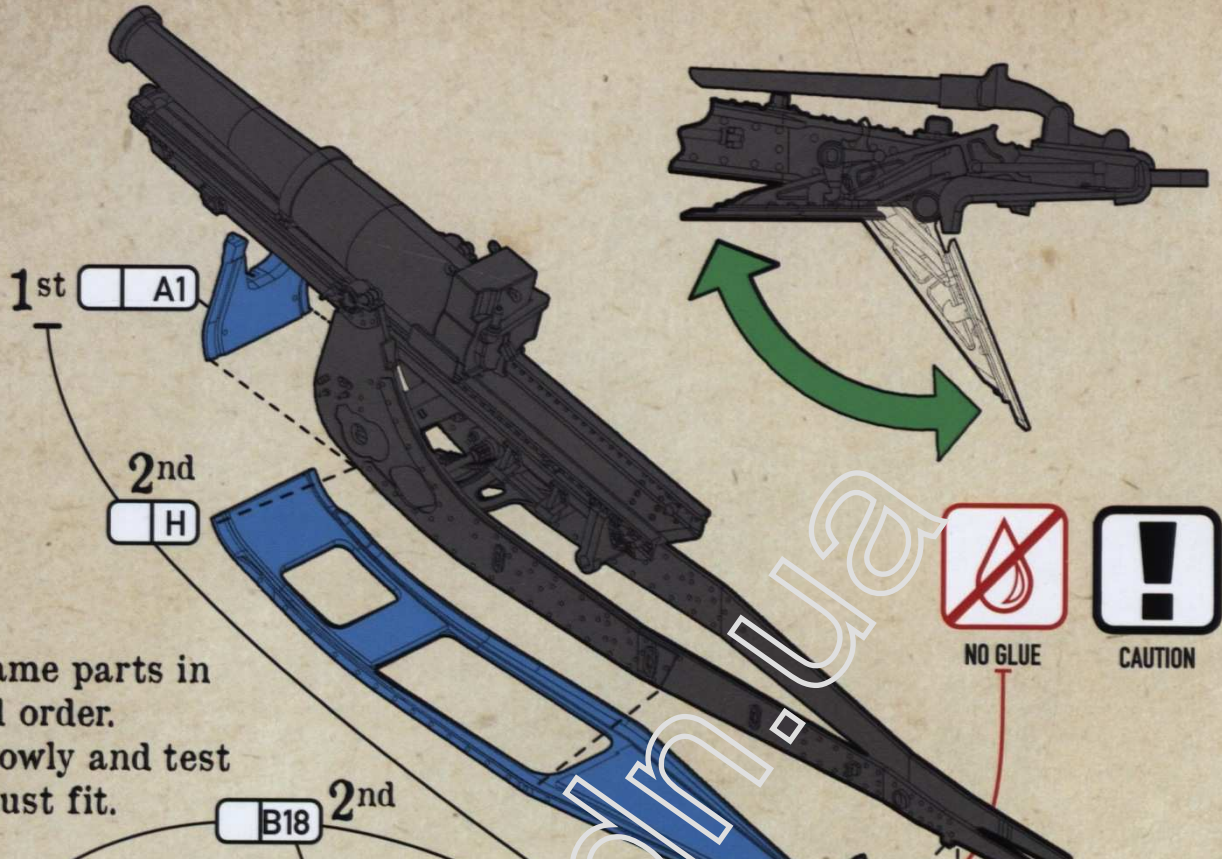

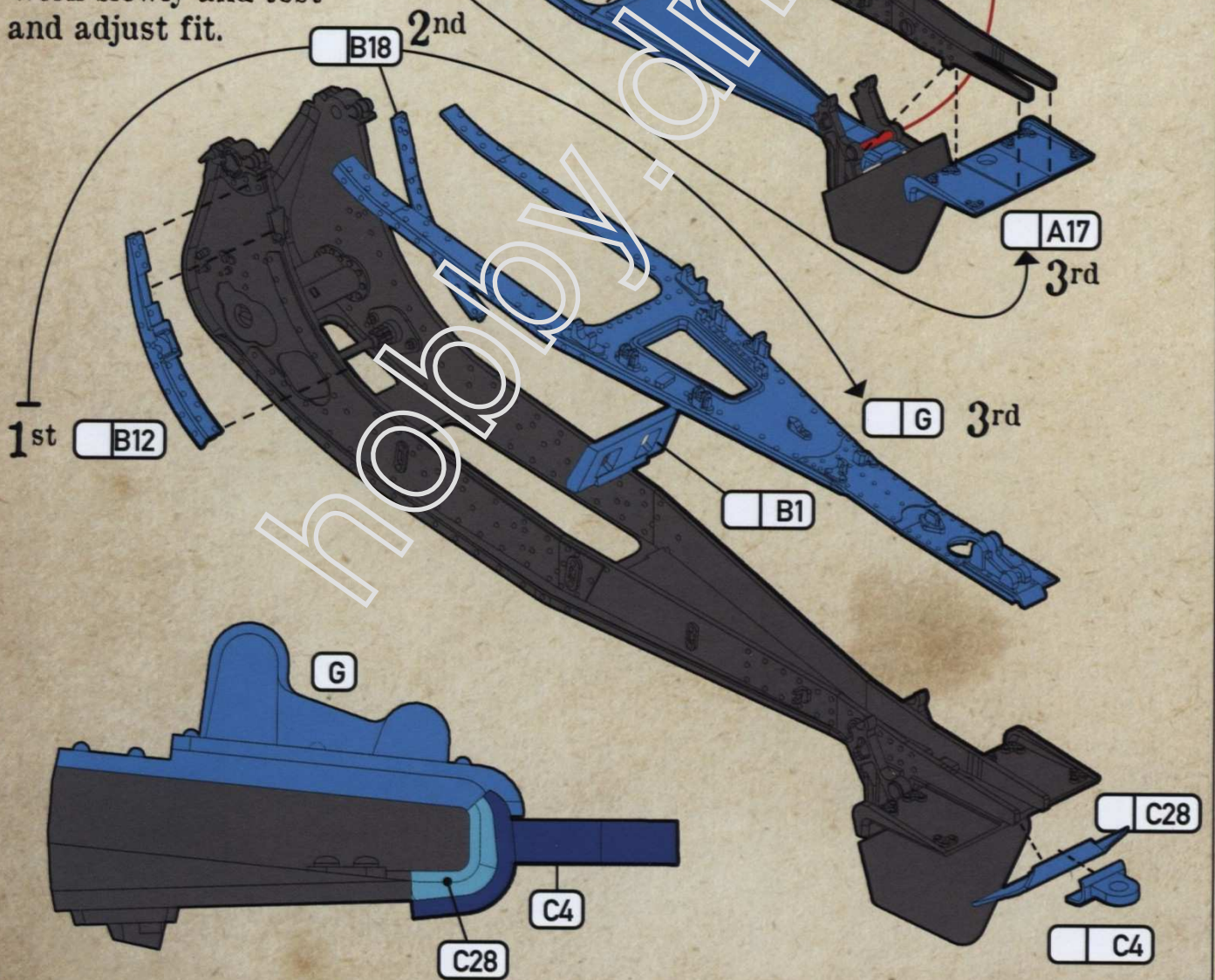

Add frame parts in labelled order. Work slowly and test and adjust fit.

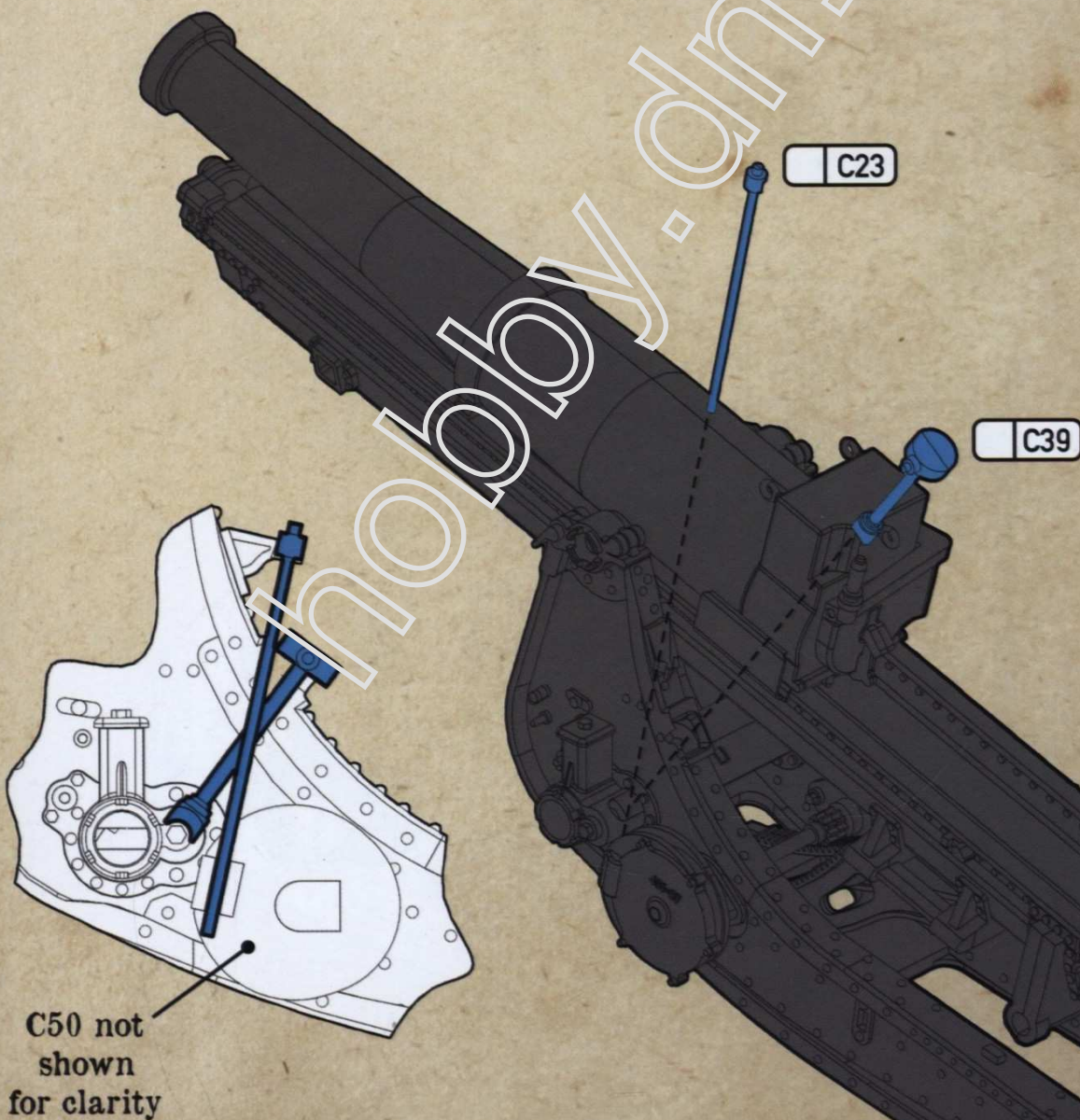
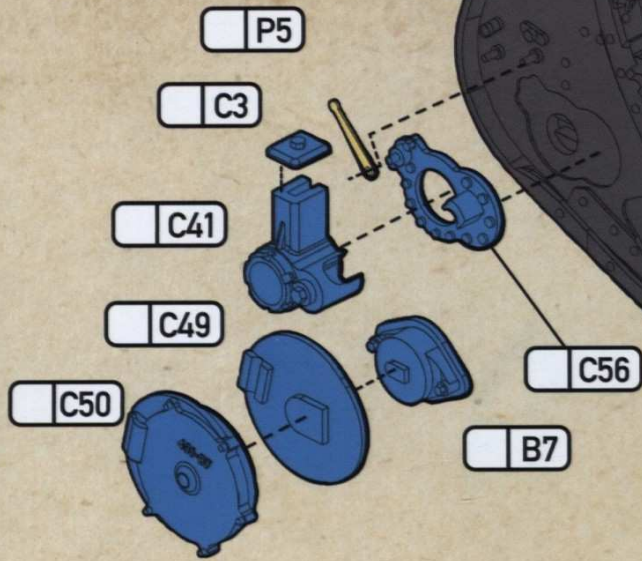



hobby.dn.ua

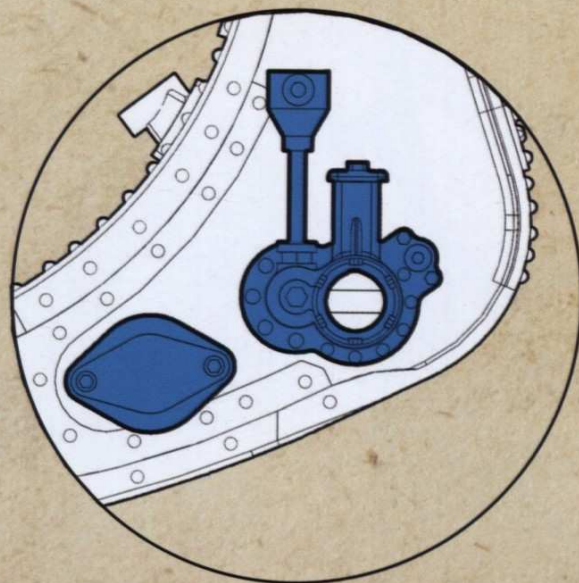

hobbydr.ua

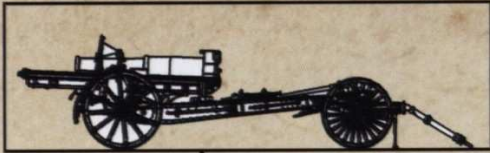

OPTION

C32

C51

C52

C53



USE CA GLUE

B19

P4

P6



SPAIN



OTHERS

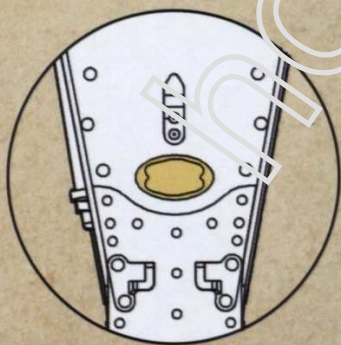

C40



CAUTION

C45

B13

C44

Gluing C40 and B13 will permanently fix the rotating spade in place

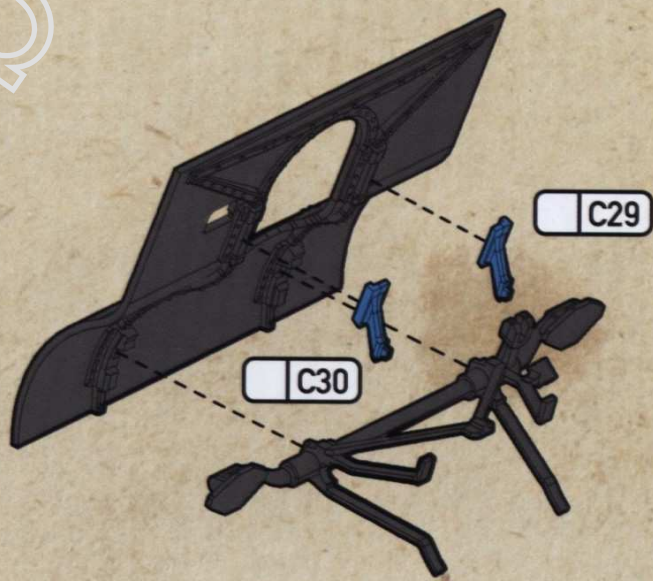
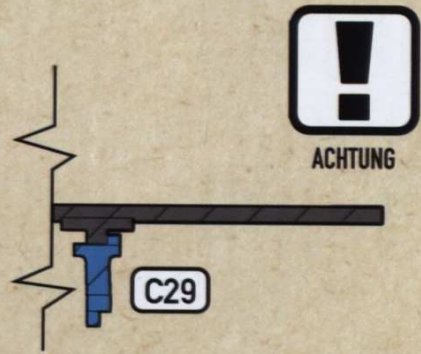
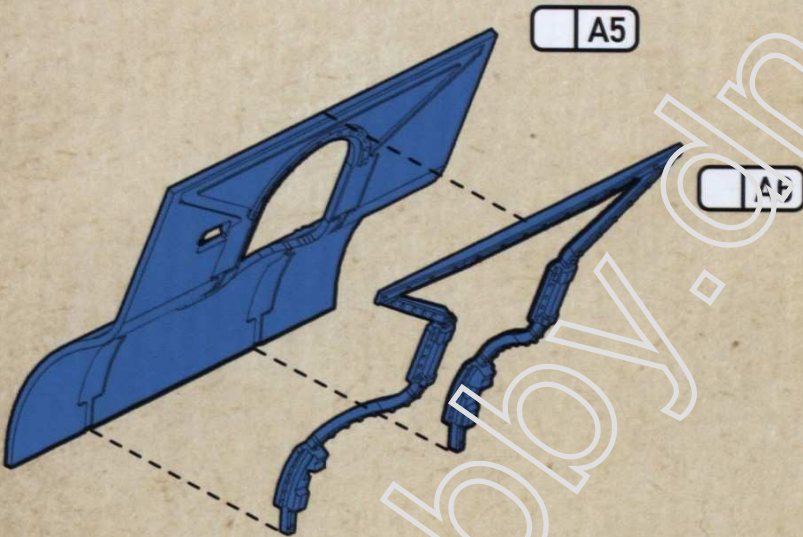
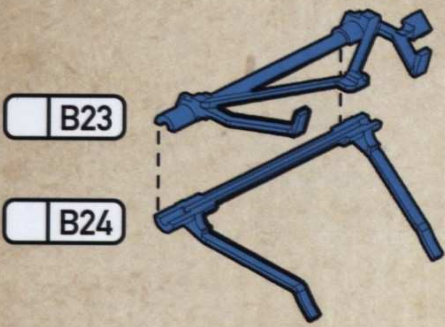

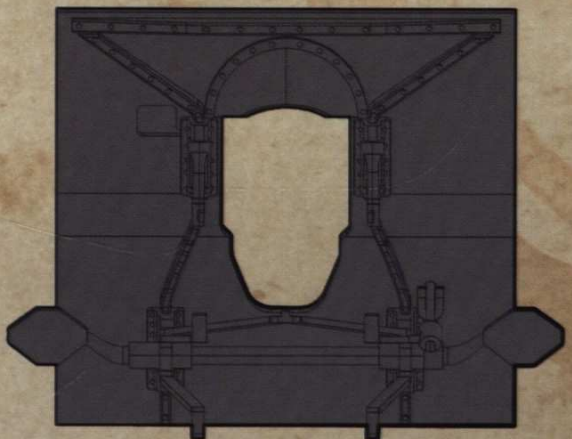
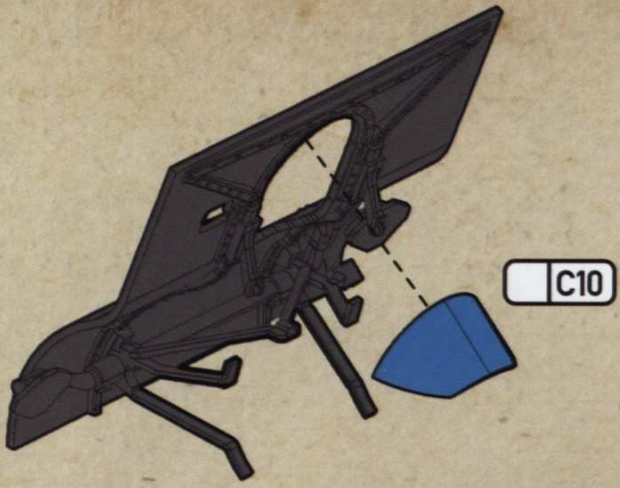

hobby.dn.ua



C36

C14

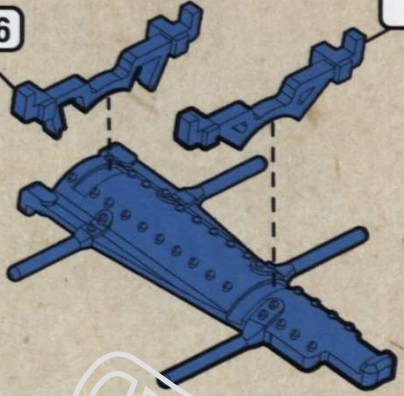

C62



nobby.dn.us

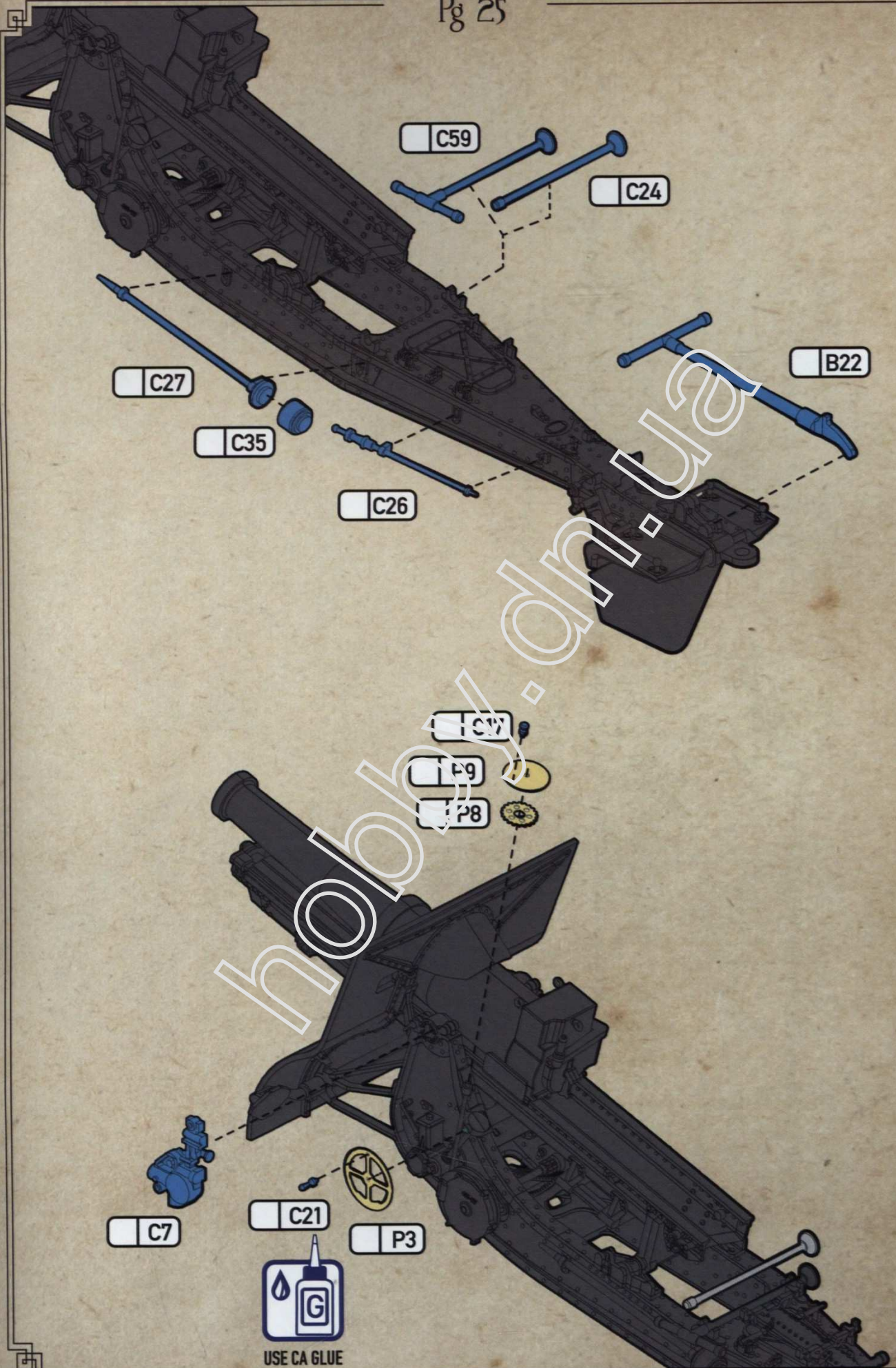



x 2
REPEAT

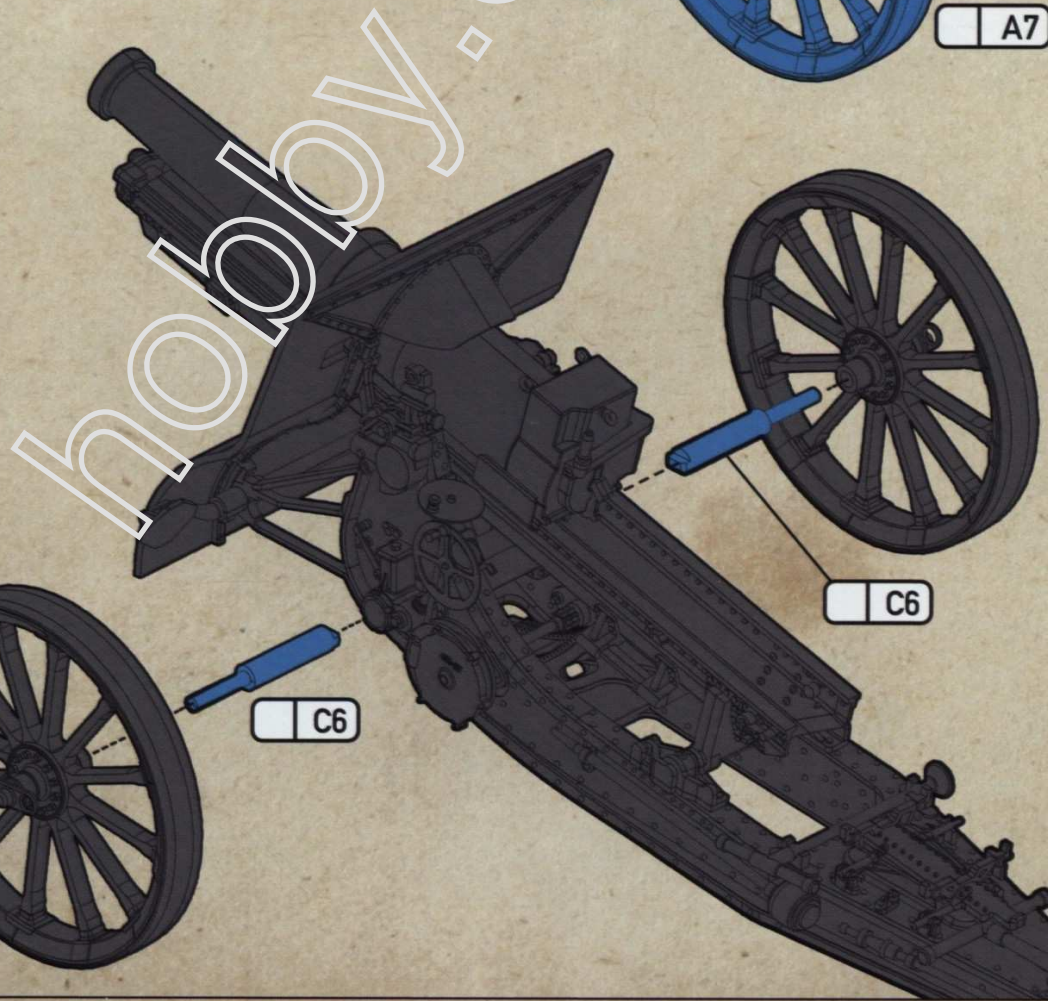
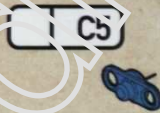
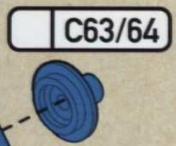

C6

C6

