



Raupenschlepper Ost RSO/01 Type 470



Vor dem Zusammenbau lesen!

DW35026

組立ての注意

- ・接着剤や塗料は火の近くで使わないでください。使う時はときどき窓を開けて換気をお願いします。
- ・部品をランナーから切り離す時は模型用ハサミ等を使い、余分な部分はカッターやヤスリ等で仕上げてください。
- ・組立図のサインマークは下の説明をごらんください。

《注意》

- ・勿於近火處使用膠水或油漆・並打開窗戶保持空氣流通。
- ・自膠架中取出部件時・應用模型專用剪・並用界刀或小鋸除去多餘的膠料。
- ・各圖型的含意可參考本欄以下的說明。

ZUR BEACHTUNG

- ・ Kleber und Farbe nicht in der Nähe von offenem Feuer verwenden und das Fenster von Zeit zu Zeit zur Belüftung öffnen.
- ・ Zum Abschneiden der Teile vom Verbundstück eine Modellierzange verwenden und die überstehenden Plastikteile mit einem Messer oder einer Feile beseitigen.
- ・ Die Bedeutung der Symbols finden Sie unten in dieser Spalte.

CAUTION

- ・ When you use glue or paint, do not use near a naked flame, and use a well-ventilated room.
- ・ When you take parts off the runner frame, use modeling scissors and trim excess plastic with a cutter or a file.
- ・ See below for the meaning of symbols.

ATTENTION

- ・ Ne pas utiliser de colle ou de peinture a proximité d'une flamme nue, et aérer la pièce de temps en temps.
 - ・ Pour retirer les pièces hors du cadre, utiliser des ciseaux spéciaux pour maquette le plastique en excès avec un cutter ou une lime.
 - ・ Voir la fin de cette colonne pour la signification des symboles
- ATTENZIONE**
- ・ Non usare colla a vernice vicino a fiamme esposte, e aprire le finestre di tanto in tanto per cambiare l'aria.
 - ・ Quando si staccano parti del carrello, usare forbici da modellismo e eliminare la plastica in eccesso con un coltello o una lima.
 - ・ Vedere in fondo a questa colonna per il significato dei simboli.

x2 2コつけてください
MAKE 2PCS
2 TEILE FERTIGEN
EFFETUER 2 PIÈCES
FARE DUE PEZZI
TEE 2 KPL
GÖR 2 ST
製作二組

切り取ってください
REMOVE
ENTFERNEN
RETIRER
SEPARARE
POISTA
AVLÄGSNA
切去

接着しないでください
DO NOT CEMENT
NICHT KLEBEN
NE PAS COLLER
NON INCOLLARE
EILIMAA
LIMMAEJ
不用黏合

テカールを貼ってください
APPLY DECAL
HIER ABZIEHBILD
APPLIQUER DECALCOMANIE
APPLICARE DECALCOMANIE
ASETA SIIRTOKUVA
APPLICERA DECALEN
貼上水印紙

穴をうめてください
FILL HOLE
SCHLIESSEN
BOUCHER LE TROU
FORD PIENO
TAYTÄ RIENKA
FYLL HÅLET
把孔填平

接着剤が乾くまで2-3分待ちます。
PLEASE WAIT FOR A FEW MINUTES UNTIL DRY
ENIGE MINUTEN WARTEN BIS DER KLEBSTOFF GETROCKNET IST
ASPETARE ALGUN MINUTI FINCHÉ LA COLLA SI È ASCIUGATA
VEUILLEZ PATENTER QUELQUES JUSQU'AU SECHAGE
VANTA NAGRA MINUTER TILLS TORR
OODTA MUUTAMA MINUUTTI KUNNES KUIVUNUT
稍候數分鐘 直至接著劑乾固

注意してください
BE CAREFUL
HIER VORSICHT
FAIRE ATTENTION
USARE ATTENZIONE
VAROIVASTI
FORIKTIGT
小心留意

穴をめてください
OPEN HOLE
ÖFFNEN
FAIRE UN TROU
FORO APERTO
AVAA REIKA
ÖPPNÄ HALET
鑽孔

接着してください
CEMENT TOGETHER
ZUSAMMENKLEBEN
COLLER ENSEMBLE
INCOLLARE INSIEME
LIMMA YHTEEN
LIMMA IHOP
用膠黏合

折り曲げてください
BEND
BITTE BIEGEN
PLIER S'IL VOUS PLAÎT
PIEGARE
TAITA
BOCKA
屈曲

どちらかを選んでください
OPTIONAL
NACH BELIEBEN
FACULTATIF
FACOLTATIVO
VALINNANVARAINEN
VALBAR
可以選擇採用

瞬間接着剤（金屬用）
INSTANT GLUE FOR METAL
METALLKLEBER
COLLA A METAL INSTANTANEE
COLLA Istantanea per Metallo
Pikalimaa Metalliosalle Varten
Snabblim för Metalldelar
金屬用速乾膠

	COLOR	RAL	Tamiya	Mr Hobby H-Series	AMMO of MIG	Vallejo	Humbrol	Mission Models
A	Black	9011	XF1	H12	0046	71.057	33	MMP-047
B	Rubber		XF85	H77	0033	71.315	85	MMP-040
C	Dunkelgelb	7028	XF60	H403	0902	71.025	83	MMP-011
D	Schokobraun	8017	XF64	H406	0015	71.041	160	MMP-012
E	Olivgrün	6003	XF58	H405	0001	71.092	86	MMP-009
F	White	9010	XF2	H11	0050	71.001	34	MMP-001
G	Leather		XF10	H463	0133	71.105	62	MMP-002
H	Gun Metal		X10	H28	0045	71.072	53	MMM-001
I	Rust		XF9 + XF10 (50/50)	H453	0040	71.129	113	MMW-005
J	Transparent Red		X27	H90	0093	70.934	19	MMP-003
K	Dark Tracks		XF56 + XF9 (80/20)	H84	0035	71.039	-	-

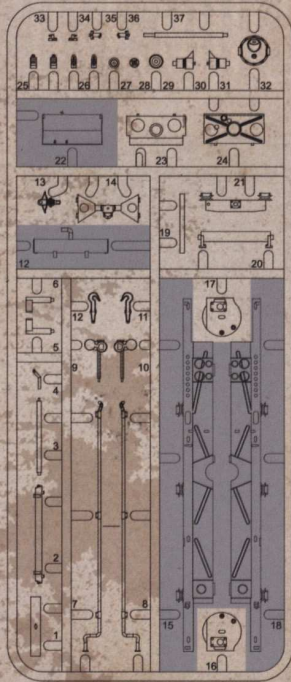
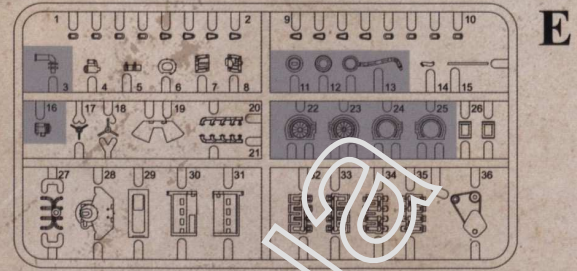
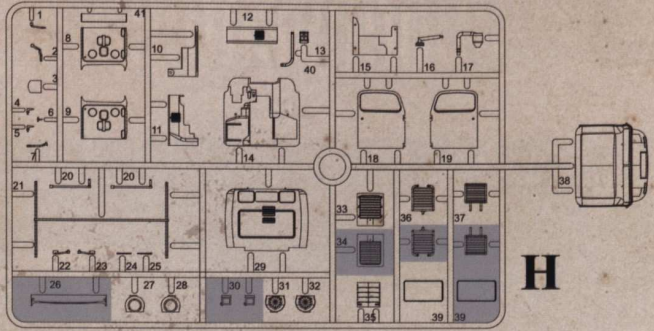
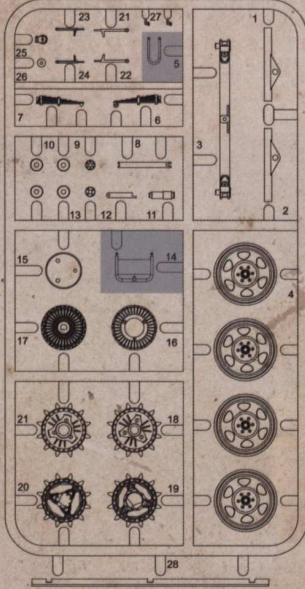
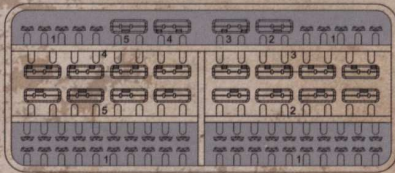
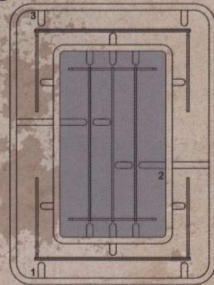
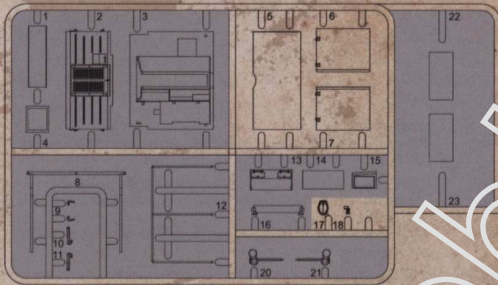
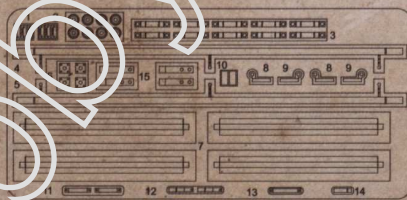
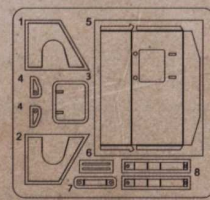
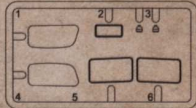
A**Bx2****M****C****J****E****MA (Photo-etched Parts)****MB (Photo-etched Parts)****J****W****Magic Tracks**
MAGNETIC TRACKS
磁性新車軌跡**Zx144**

この部品は使用しません
Parts not for use.
Deze worden niet gebruikt.
Partes a no usar.
Parti non utilizzati.
不要な部品の図

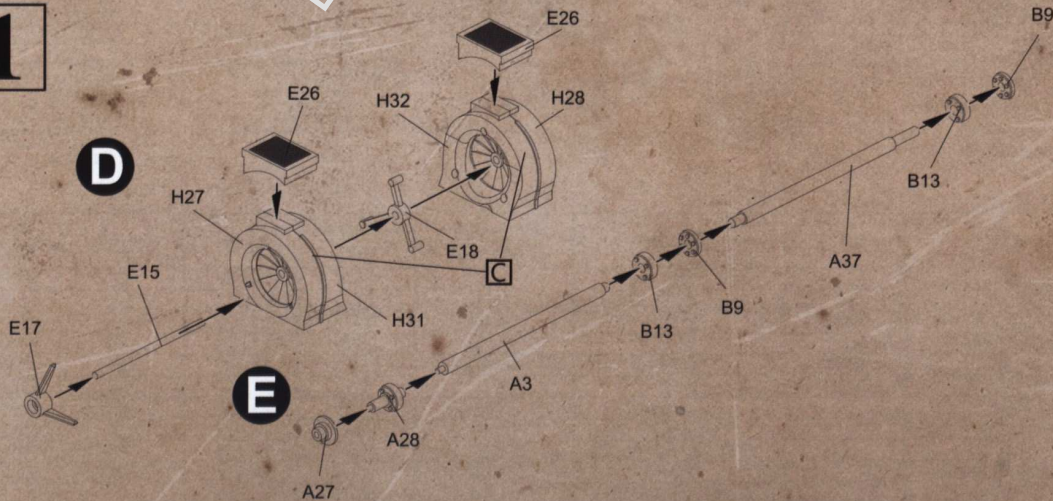
1

2

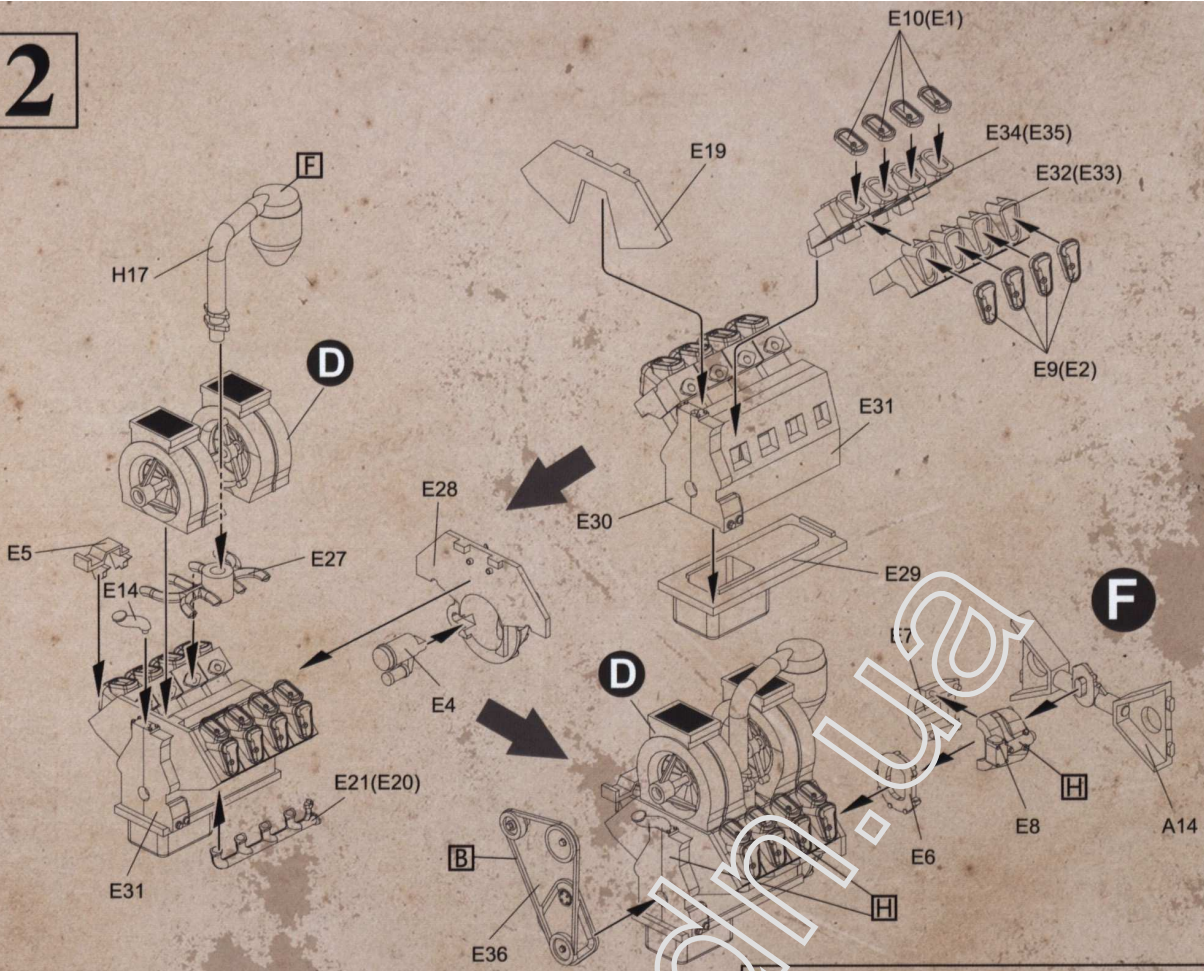

3

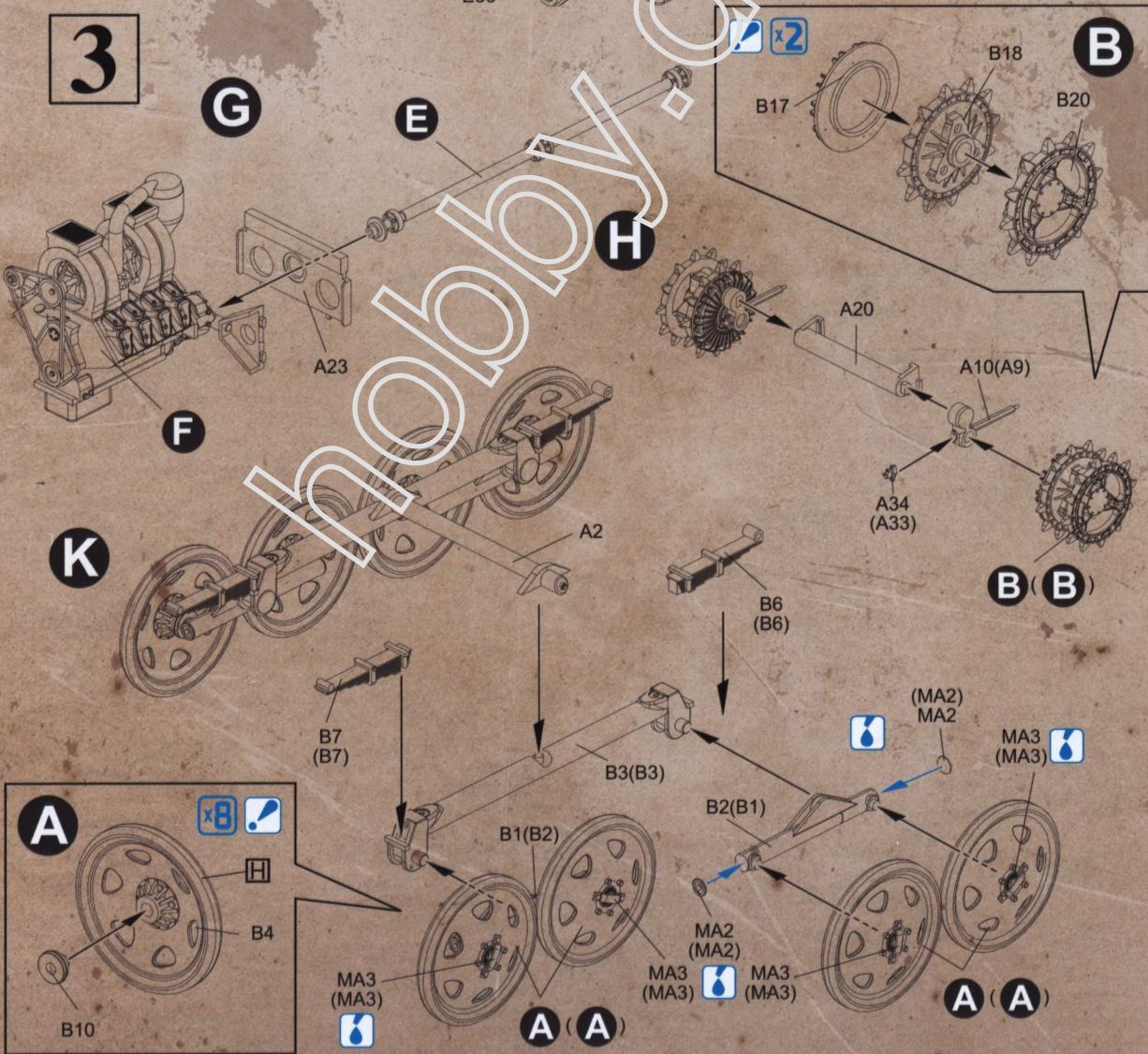

4

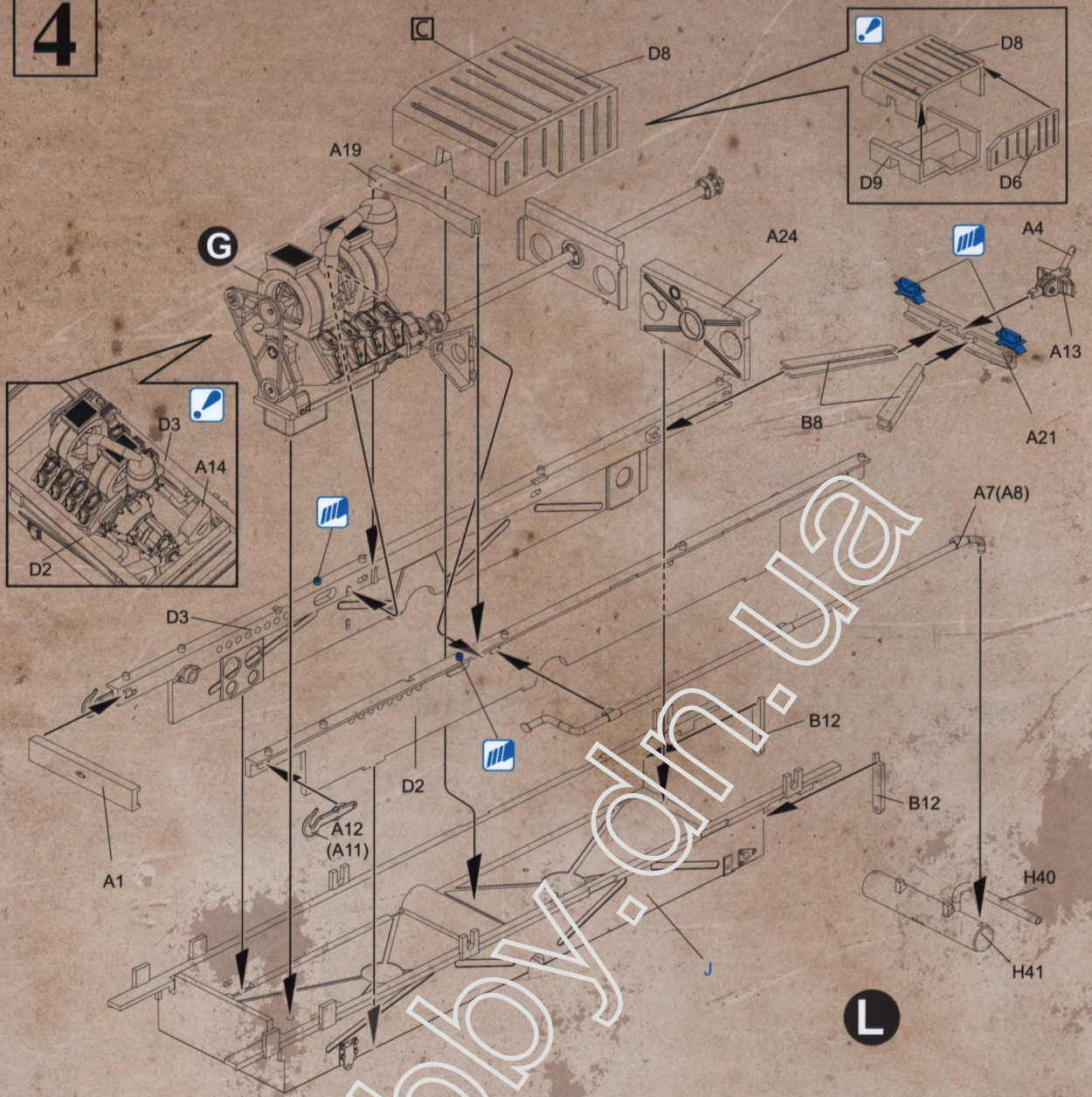

5

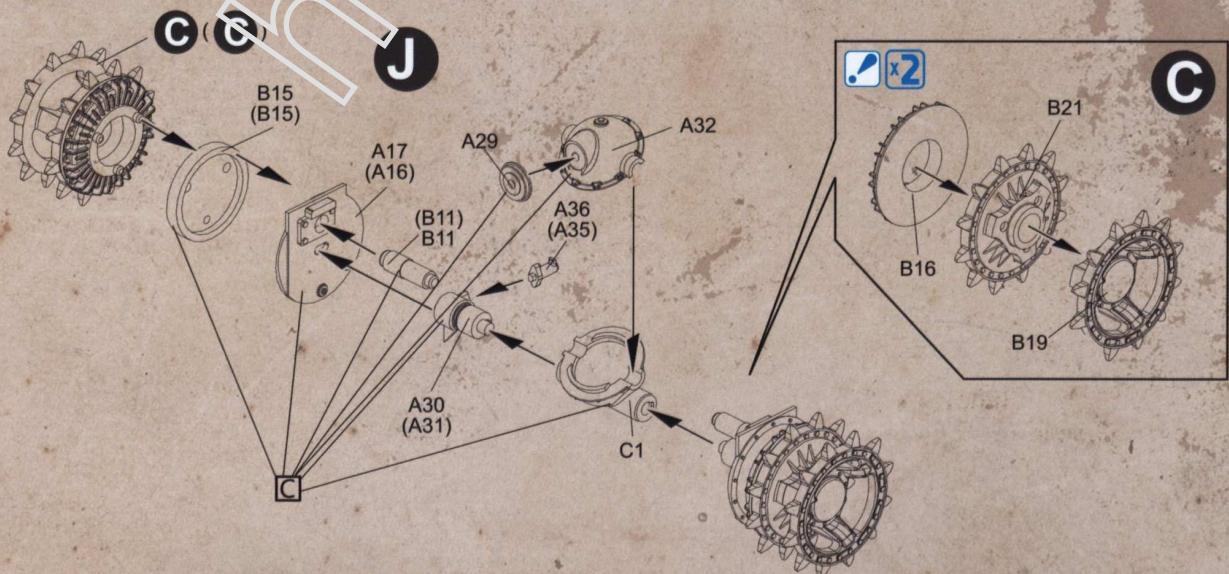

6

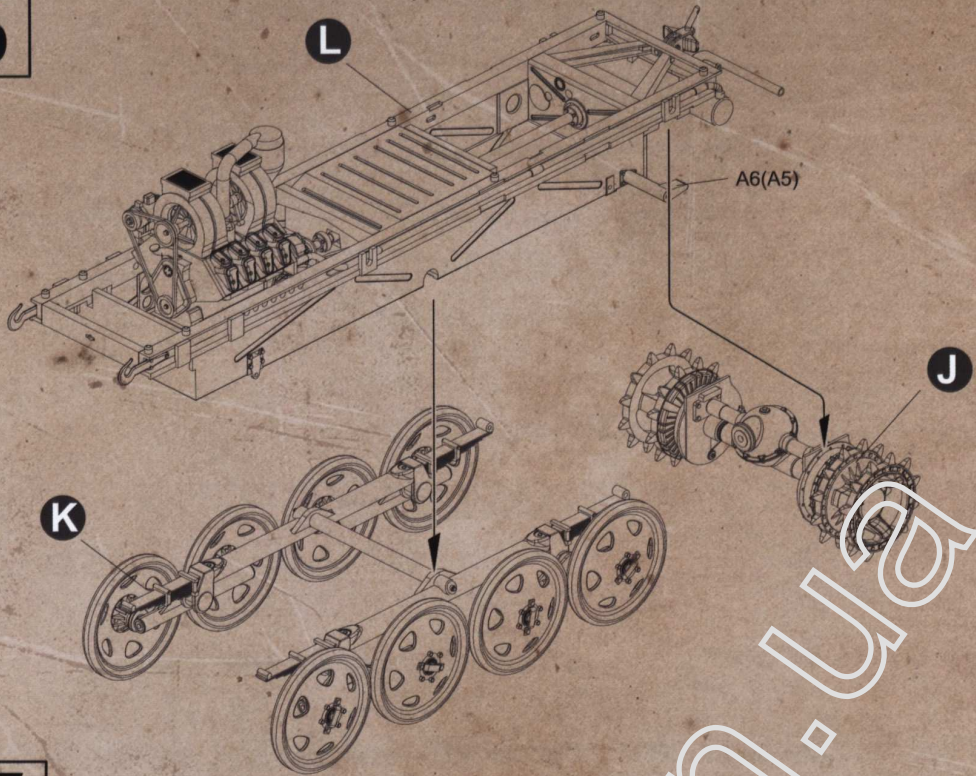

7

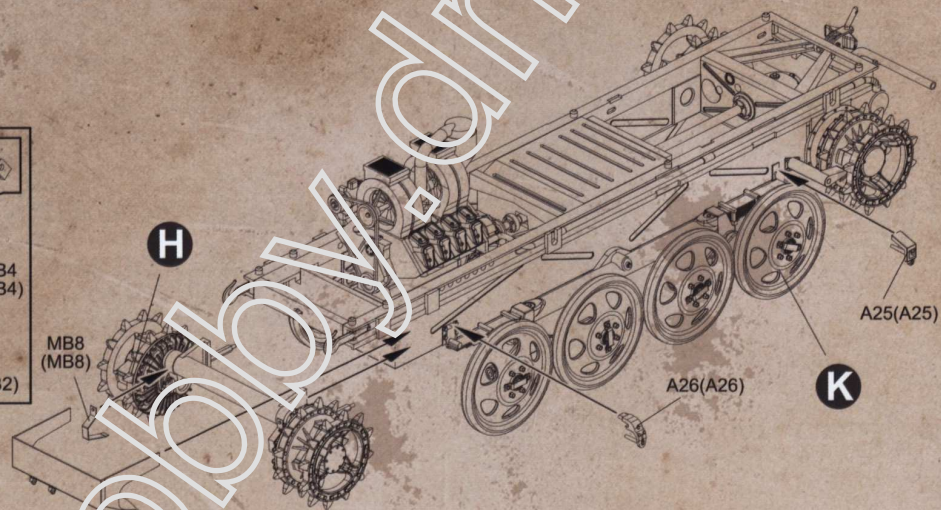
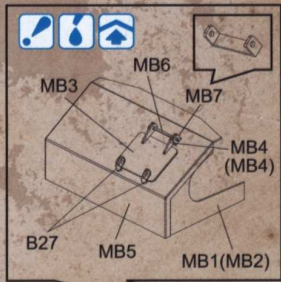

8

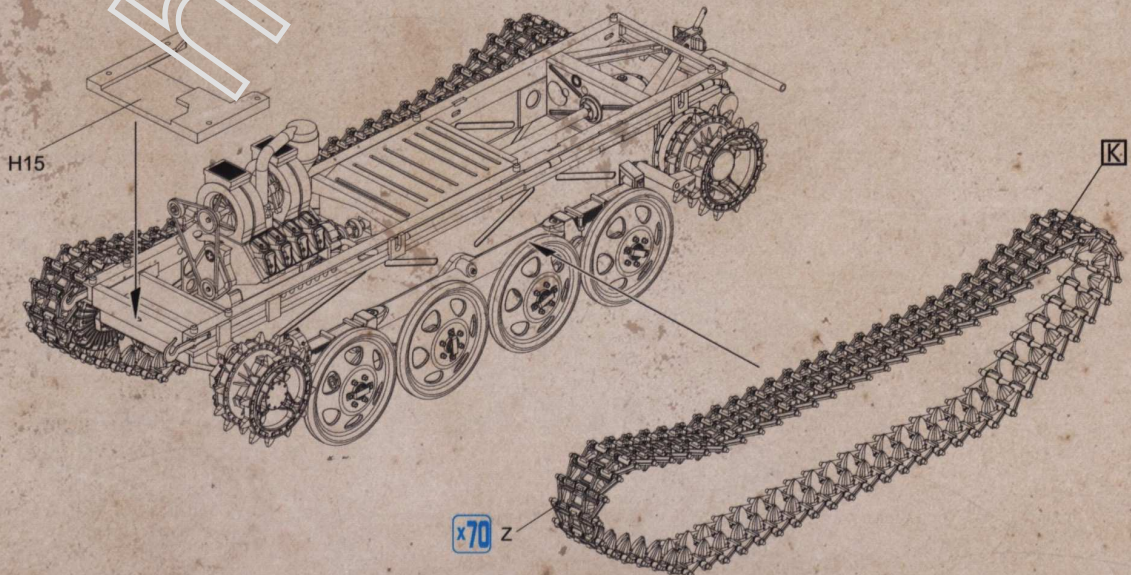

9

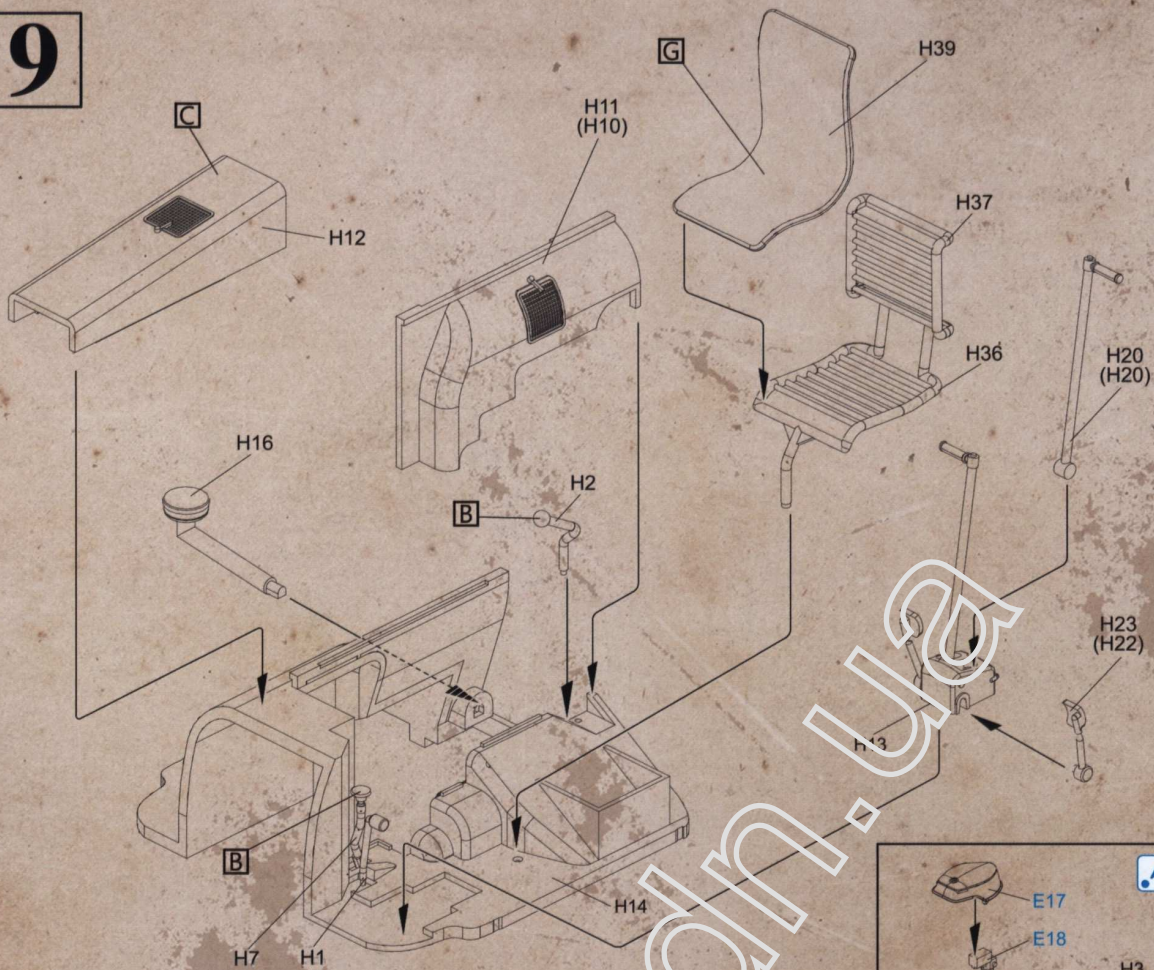

10

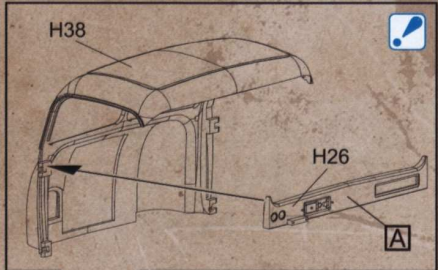
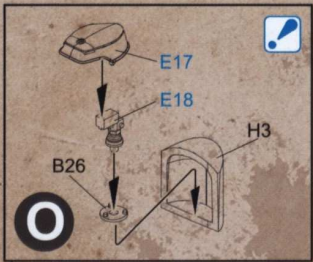
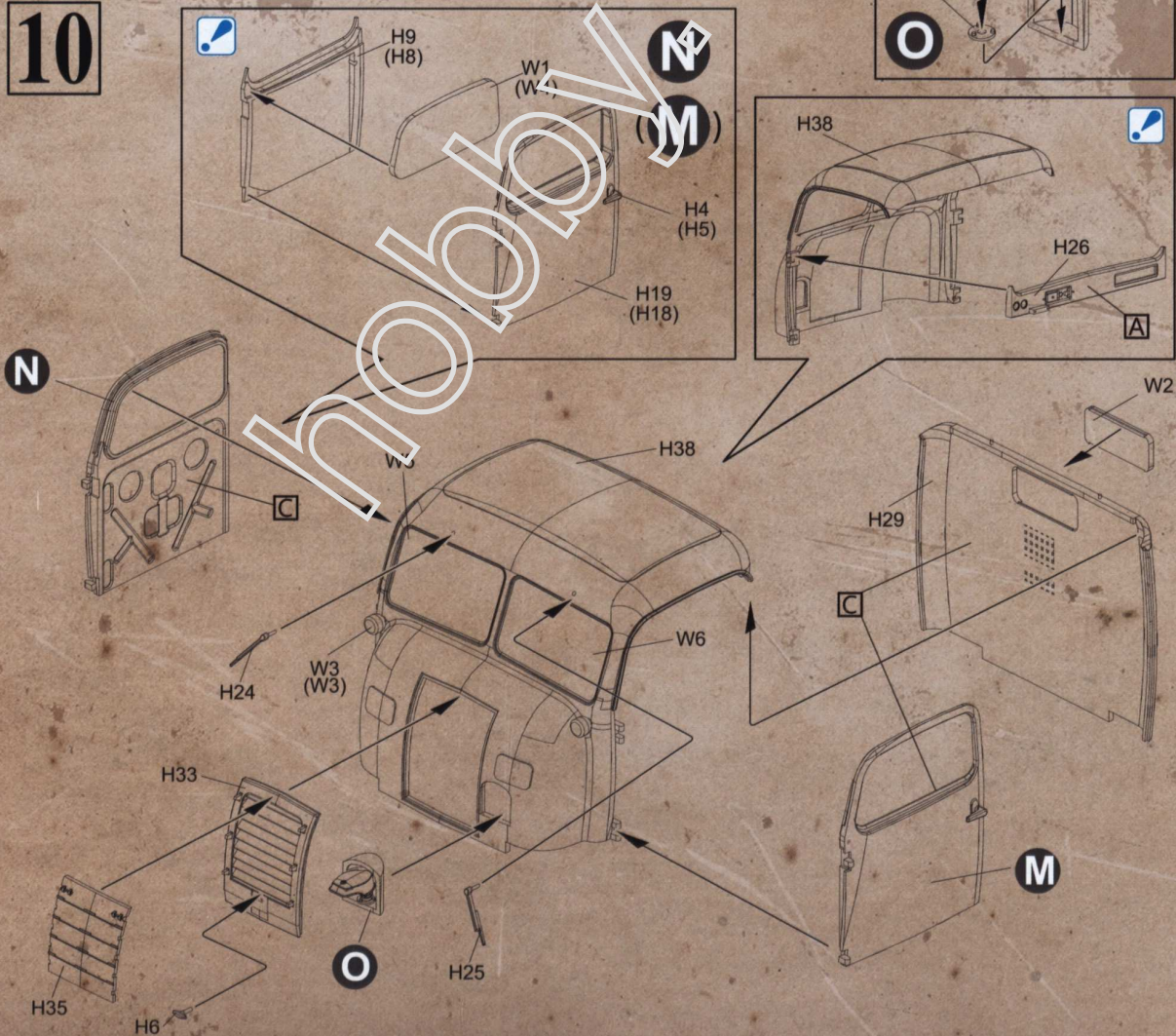

11

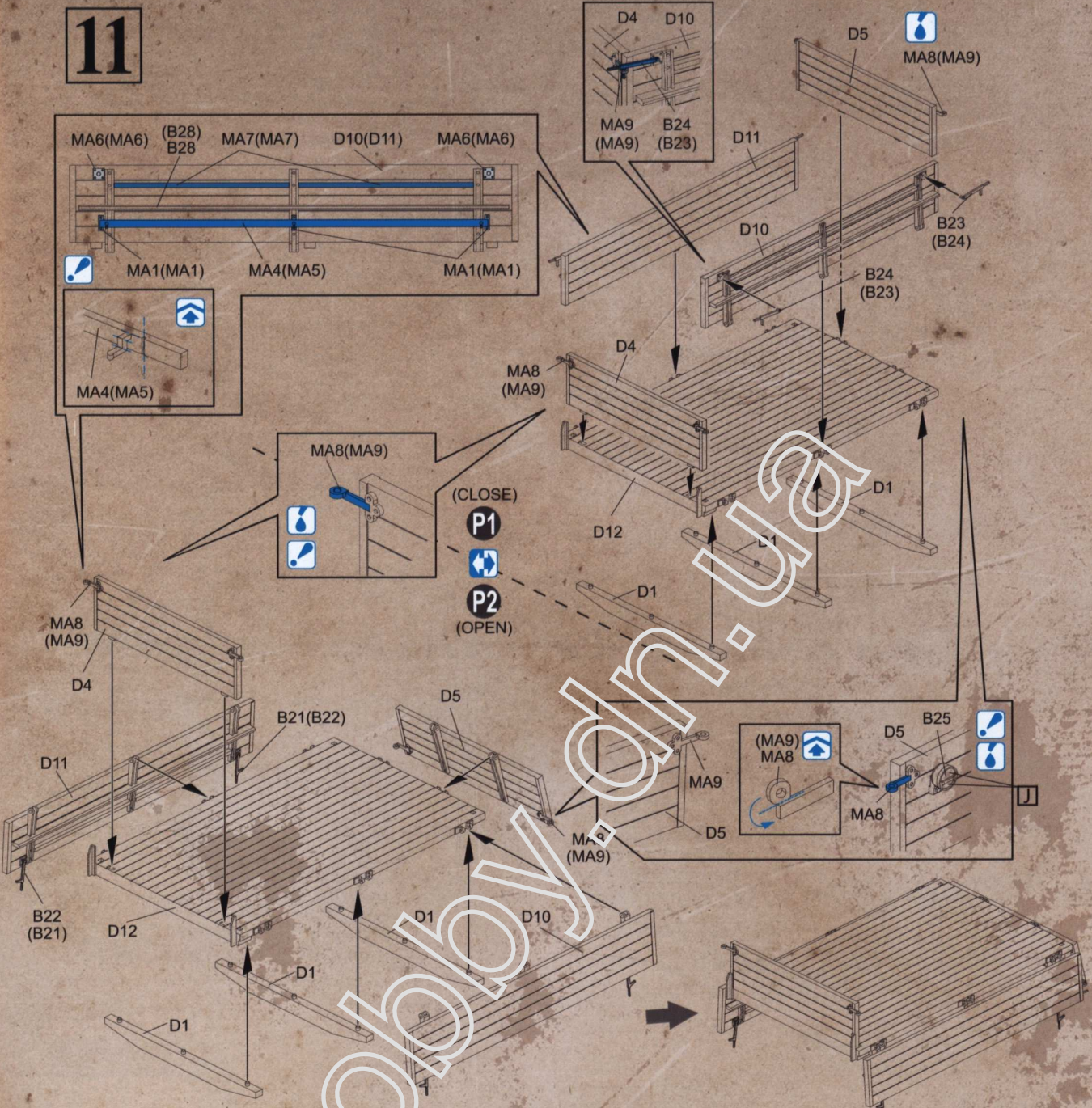

12

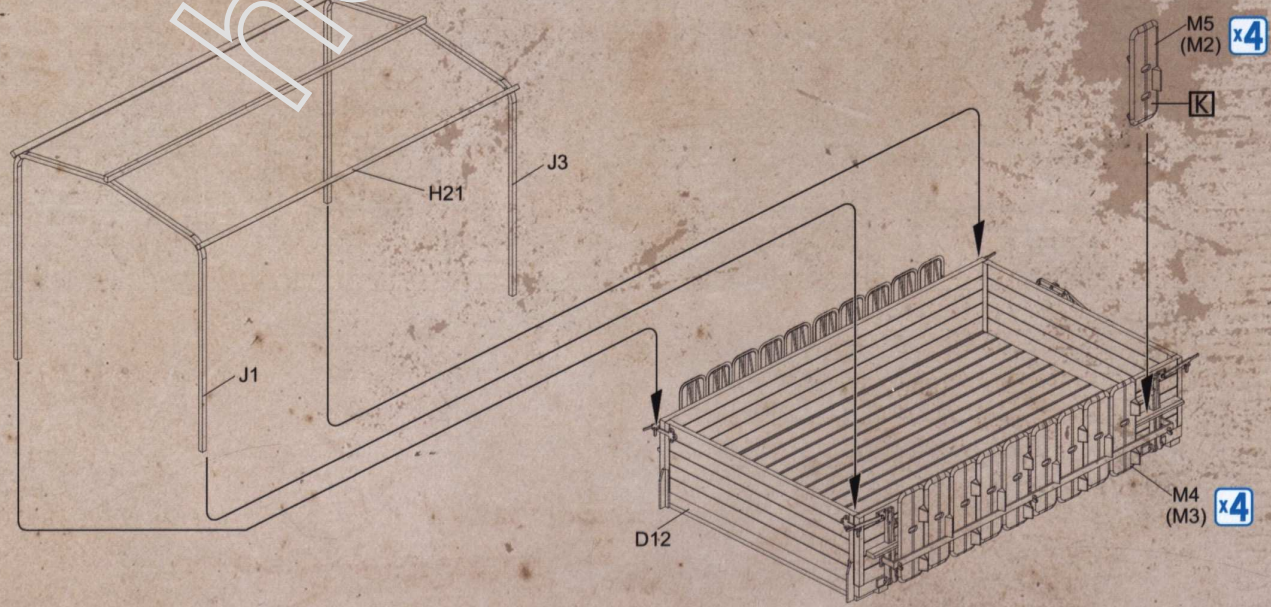

13

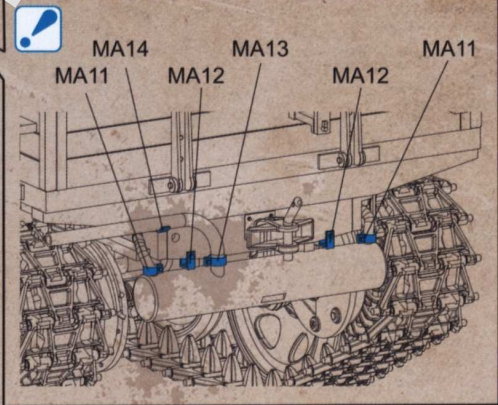
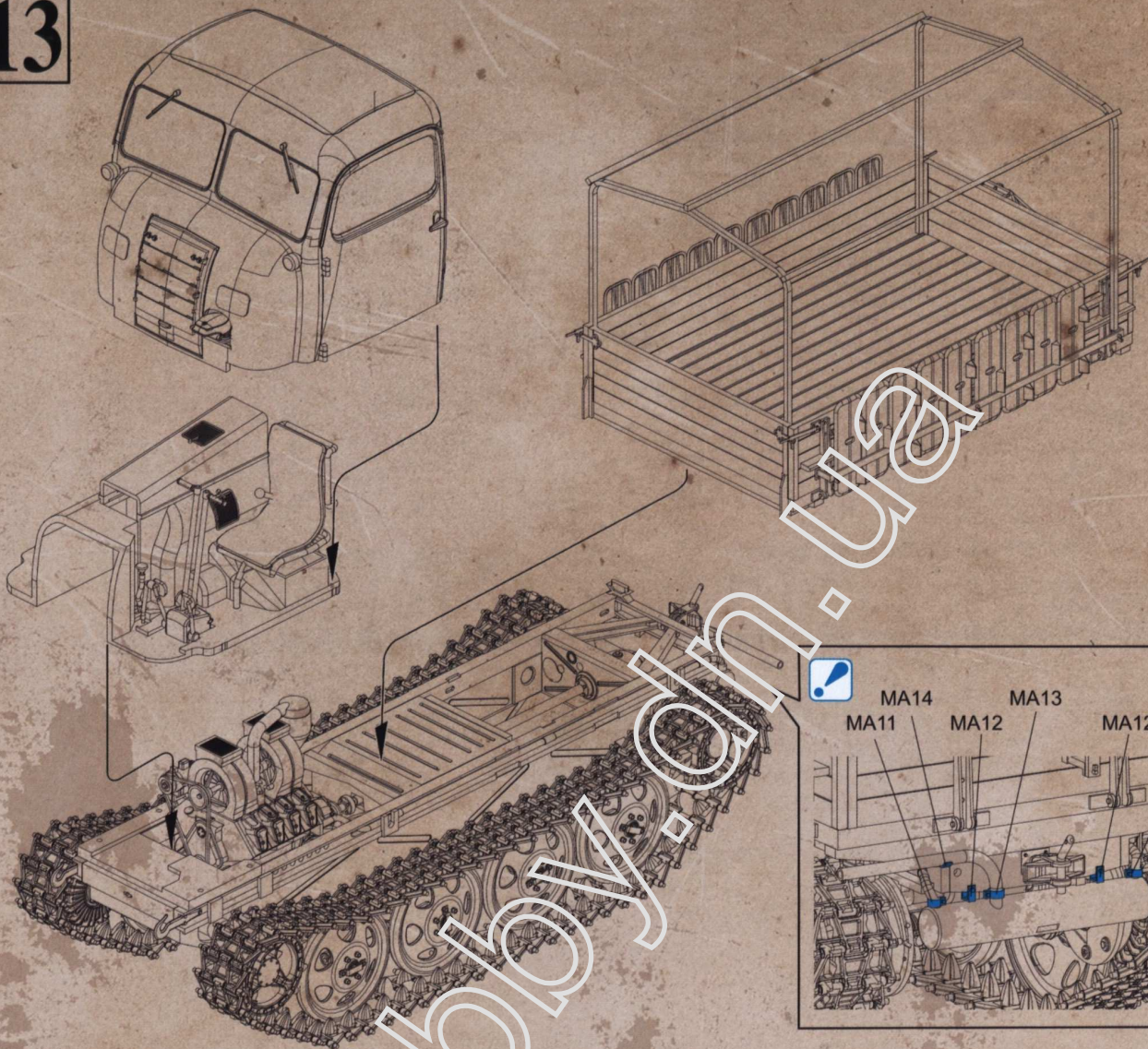

Using Window Masks prior to painting

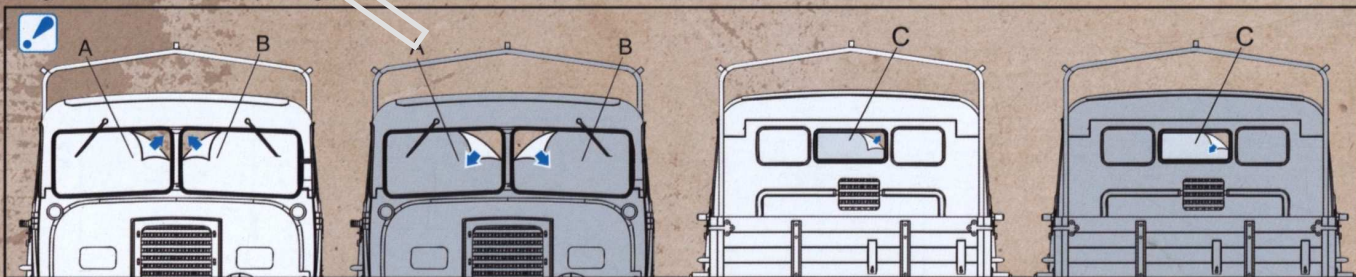

Painting and Marking Guide

19.Volksgrenadier Division, Western Front, 1944/45

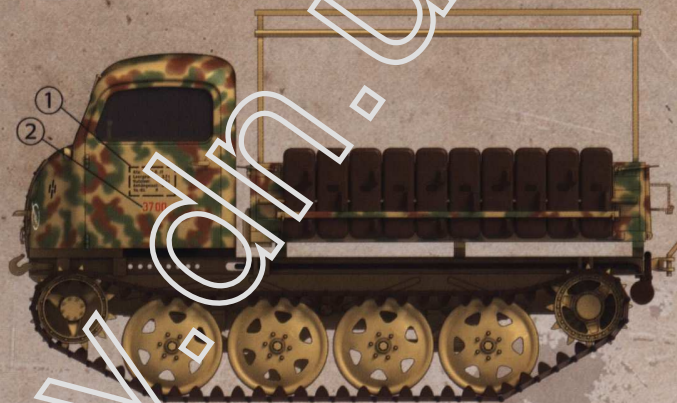
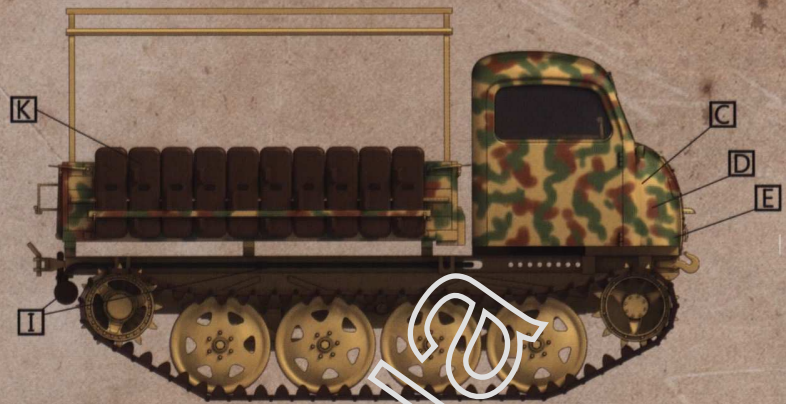
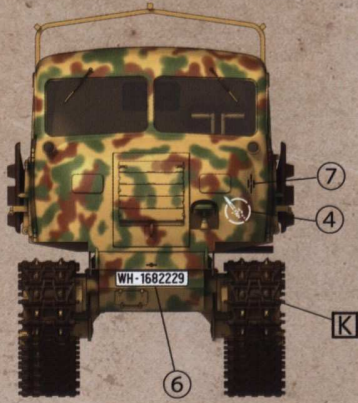

Art.Abt.430, Eastern Front, 1943

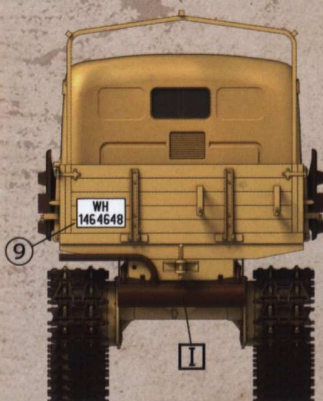
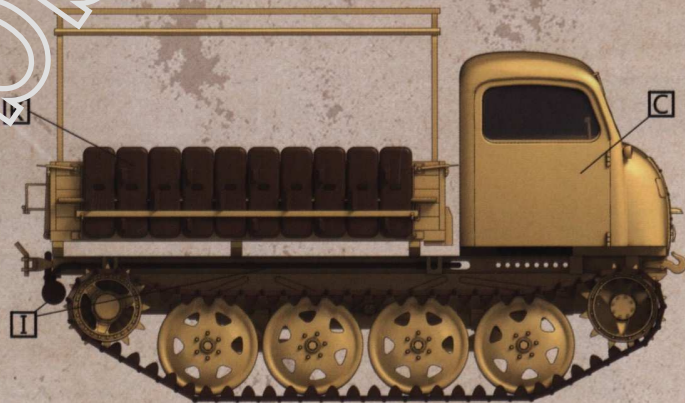
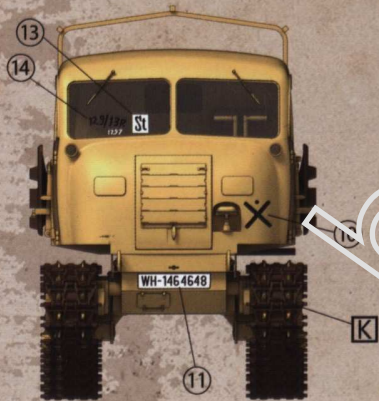

Painting and Marking Guide

Unknown Gebirgsjäger unit

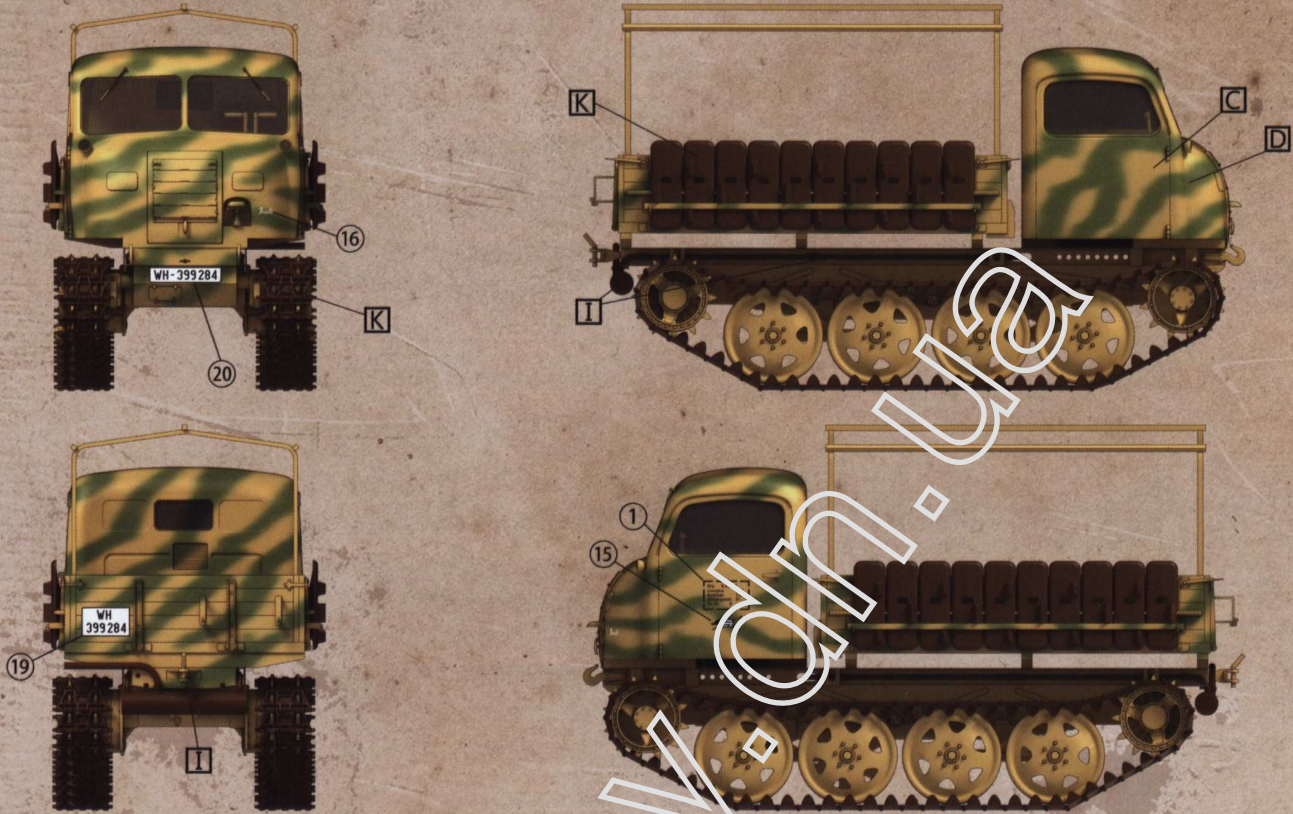

Grenadier Rgt.154, 58.Infantry Division, Eastern Front



RSO/OI Type 470

Painting and Marking Guide

Nachrichten Abteilung 45, Hungary, 1944

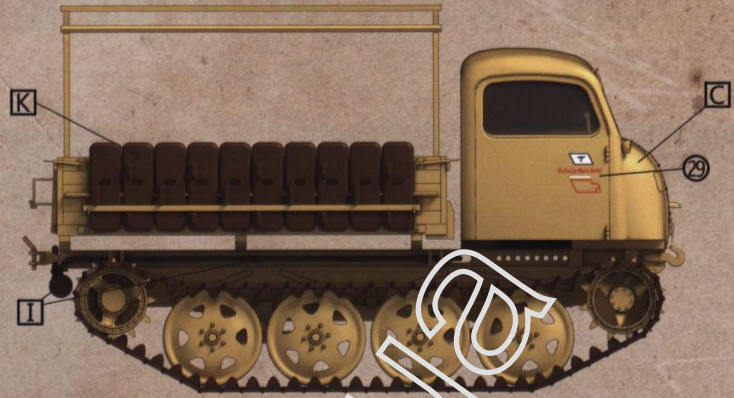

Unknown Unit, Eastern Front, summer 1944

