

632 095 CBU-105

eduard
BRASSIN

1/32 scale



R3
6pcs.



R4
6pcs.

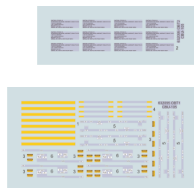

COLOURS

GSI Creos (GUNZE)			Mr.METAL COLOR	
AQUEOUS	Mr.COLOR			
[H 2]	[C 2]	BLACK		
[H 8]	[C 8]	SILVER		
[H 52]	[C 12]	OLIVE DRAB		

This product contains metal and resin detail parts for upgrading scale plastic models. When selecting this set make sure that it is for the kit mentioned in product name as these sets are made specifically for that kit. When upgrading the model some cutting or corrections may be necessary for parts to fit accurately. **WARNING!** This set contains small and sharp parts. Work carefully in a ventilated and well-lit room. Safety glasses are recommended. This product is not suitable for children below 14 years of age.

Tento výrobek obsahuje leptané a odlévané detaily pro úpravu a vylepšení plastického modelu. Při výběru sady kovových detailů zkontrolujte, zda je určena pro model, který chcete upravit. Model, pro který je sada určena, je uveden u názvu výrobku. Pro přesnou aplikaci kovových a odlévaných dílů může být zapotřebí upravit díly upravovaného modelu. **POZOR!** Sada obsahuje malé ostré díly. Pracujte ve větrané a dobře osvětlené místnosti. Doporučujeme použití ochranných brýlí. Tento výrobek není vhodný pro děti mladší 14 let.

eduard

435 21 Obrnice 170
Czech Republic

www.eduard.com



632 095 CBU-105

1/32

BRASSIN

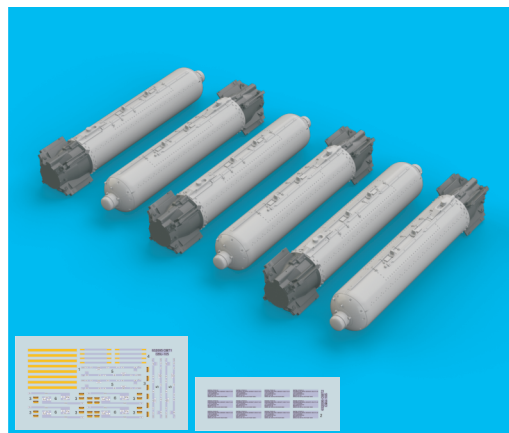





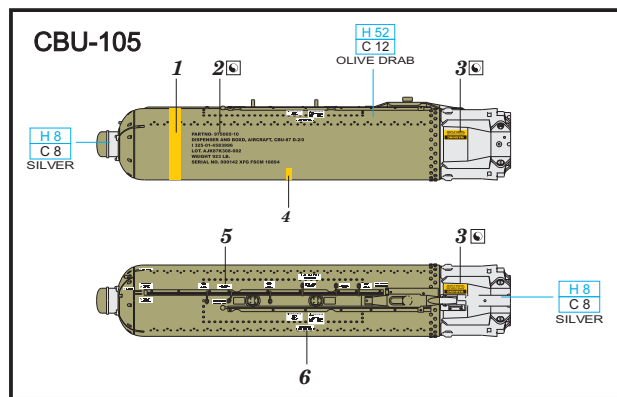



BRASSIN

eduard



BEST BRASS RESIN AROUND!

- | | |
|---|---|
|  REMOVE
ODSTRANIT |  BEND
OHNOUIT |
|  GRIND
OBROUSIT |  OPTION
VOLBA |
|  DRILL HOLE
VRTAT OTVOR |  REPLACE
NAHRADIT |
|  SYMMETRICAL ASSEMBLY
SYMETRICKÁ MONTÁŽ | |
|  SCRIBE THE PANEL AND HOLES
RYTI | |
|  REVERSE SIDE
OTOČIT | |

6 pcs.

