

1:35 Scale

Item No.:83865



Soviet T-38 Amphibious Light Tank

ソビエト T-38 水陸両用軽戦車 □ 苏联T-38水陆坦克

PLEASE READ BEFORE OPERATION!

- * Tools recommended as below: (Not included)
Adhesives; Paints; Side Cutters; Sharp Edged Pliers; Modeling Knife; Modeling File; Nippers; Drill; Scissors; Sand Paper; Soft Cloth; Cyanoacrylate Glue.
- * Make sure to read this instruction listed below before assembling.
- * The kit contains the small parts, they can be dangerous if swallowed by mistake, so keep them away from reach of children.
- * Cut the all parts off carefully and remove the waste parts into the garbage can.
- * More caution and care should be needed for cutting and handling the photo etched parts.
- * Make attention that some parts should be attached the decal when assembled.
- * During assembling, please tear up and throw away the plastic bags, or may cause the dangerous if wearing over head by children's mistake.
- * When using the adhesives and paints, please do not use them in the closed room or near the fire, also must be very careful to protect your eyes, face and clothes.
- * Adult supervised when assembled by children under 14 years old.

装配前请仔细阅读:

- * 推荐使用的模型工具(请自备):
专用模型胶水, 专用模型油漆, 水口剪刀, 长咀钳, 刀片, 锉刀, 镊子钳, 钻, 剪刀, 软布, 砂纸, 瞬间快干胶等。
- * 用水口剪刀或刀片小心切下所有塑胶零件和蚀刻片零件, 不要遗失小零件。
- * 切取蚀刻片时应特别注意防止利边划伤手指。
- * 用模型锉刀小心锉平所有零件表面的注射浇口。
- * 用适量的强力快干胶水粘合蚀刻片零件和金属轴, 切忌过量, 否则可能导致可动零件被粘住。
- * 注意某些零件表面需在装配时同步贴水上水贴纸。
- * 制作时应远离幼儿并将包装袋及时收妥, 谨防小孩玩耍而引起意外。



cyanoacrylate glue
强力胶



weight
配重



drill hole
钻孔



cut / remove
切除



option
选择



no cement
不涂胶水



decal
贴纸



bend
弯曲



repair
填补

The method to apply the decals

1. Cut off the decal from the decal paper and put it into the warm water 40°C for 10 seconds.
2. Take the decal from the water and put it on a piece of clean cloth.
3. Remove the decal slowly from the paper to the targeted location by a wet finger.
4. Use a piece of dry and soft cloth to press it gently on the decal until it getting dry and no bubble existing.

水贴纸的使用方法:

- 一. 把相关的印花从水贴上剪下, 放入40°C左右的温水中浸10秒。
- 二. 然后将印花放在干净的布上。
- 三. 拿上印花纸板, 手指蘸水将印花移到适当的位置。
- 四. 用软干布轻压印花直至水干, 气泡消失。

部品图
Parts

《车底》
Lower hull

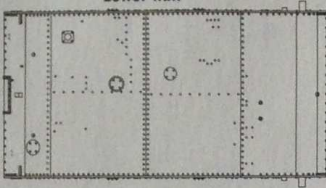

《炮塔》
Turret



Ax2

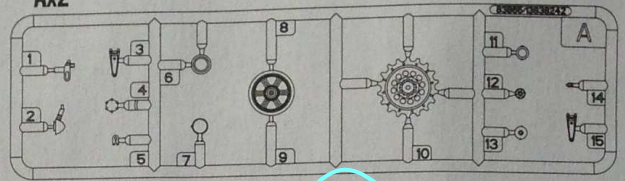

Bx4

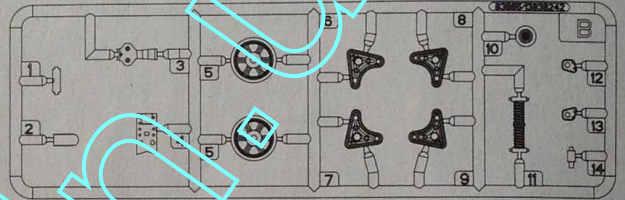

C

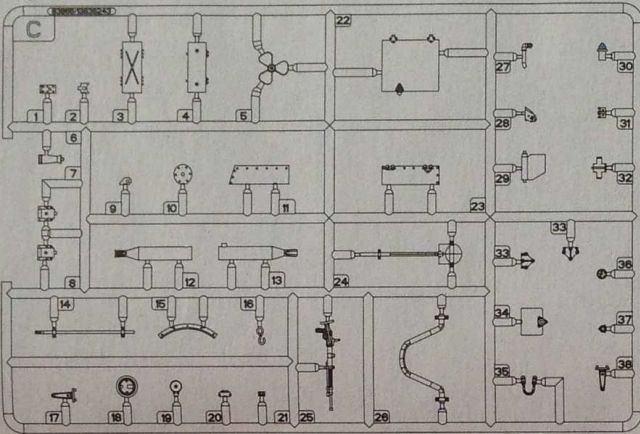

D

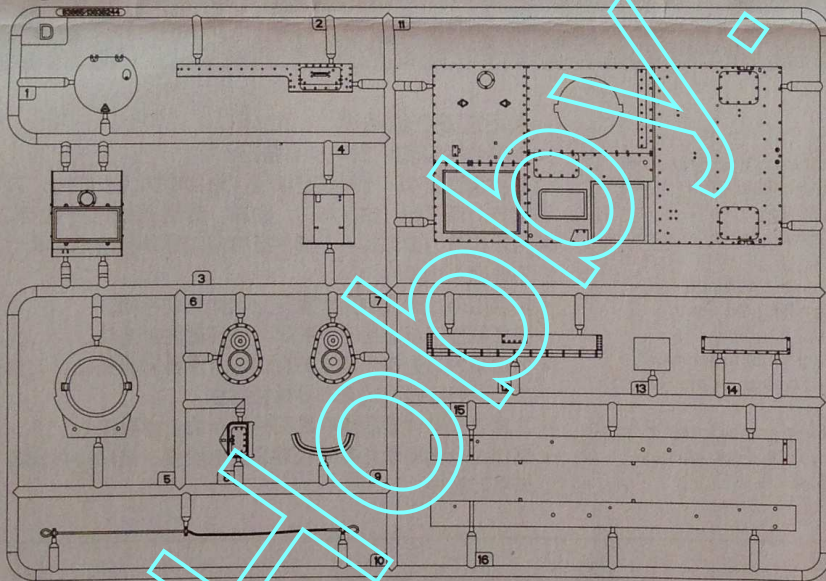

《铜丝》:Ø0.35x110mm
Brass wires

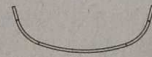

《水贴》
Decal



《蚀刻片》
Photo Etched

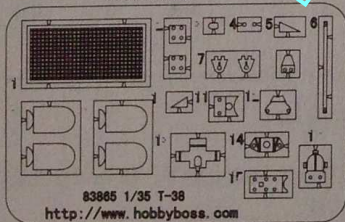

Tx7

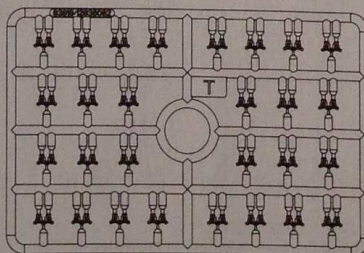

1
STEP

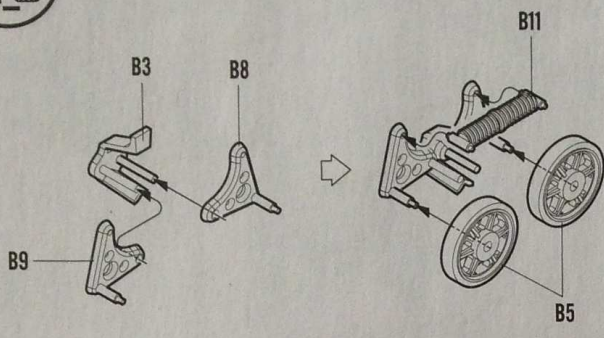

Bend PE-9
弯曲

?
Option
选择

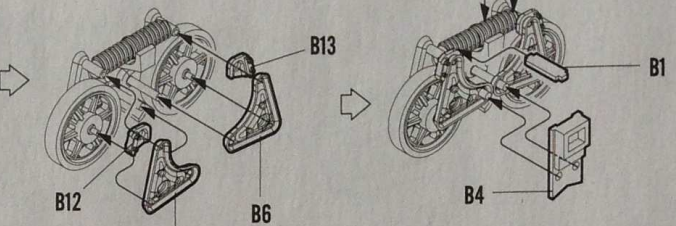

Bend 《铜丝》 X22mm
弯曲 Brass wires

《铜丝》
Brass wires

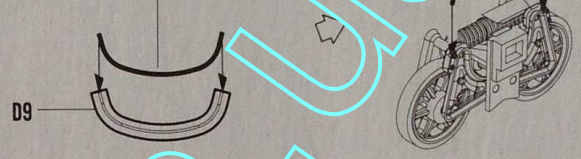

<<A-A>>
制作4组
Make Four

2
STEP

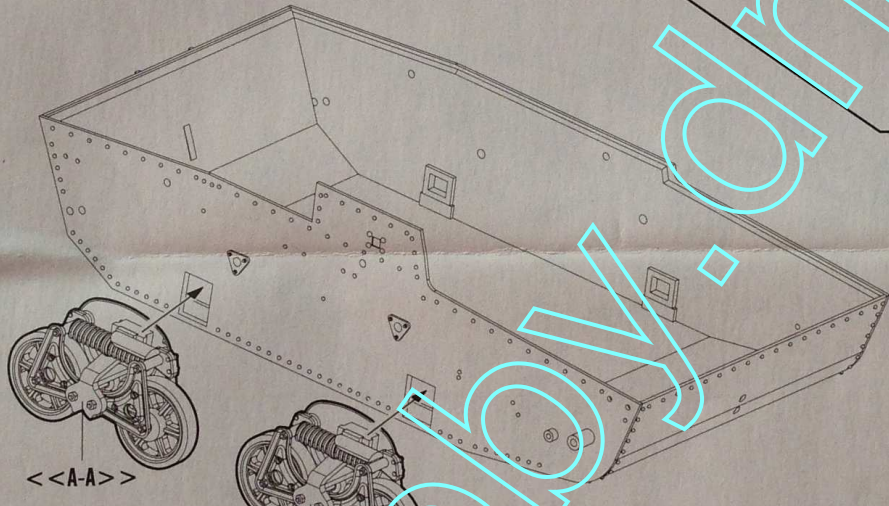

<<A-A>>

对侧相同
Both sides

<<A-A>>

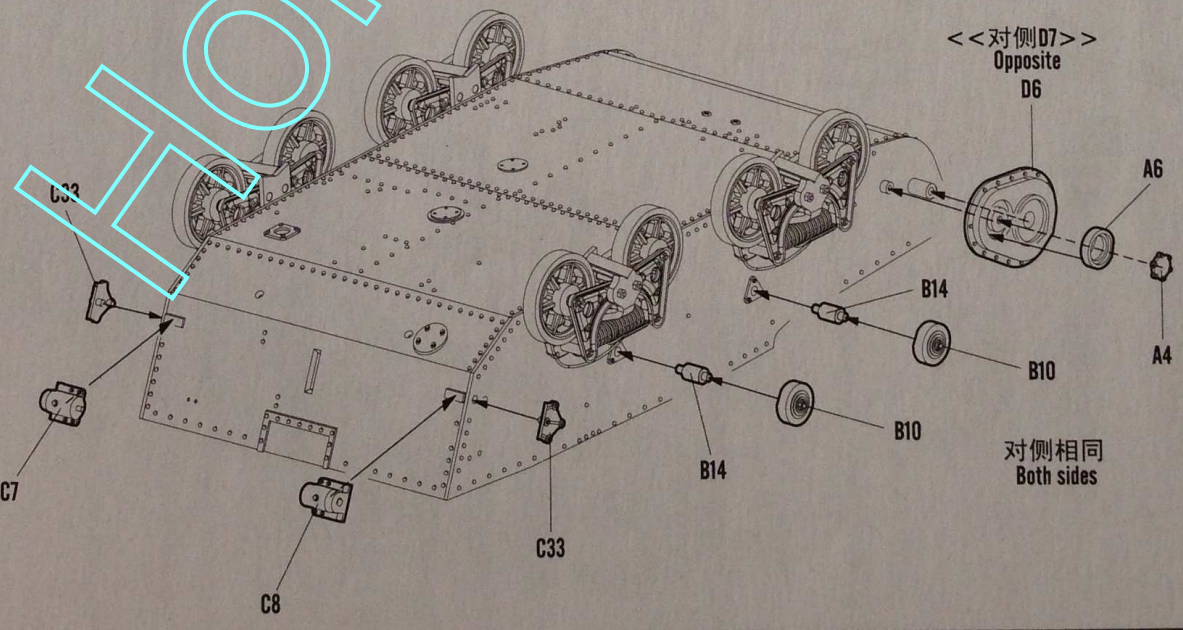

<<对侧D7>>
Opposite
D6

对侧相同
Both sides

3
STEP

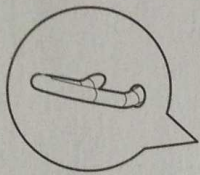

《铜丝》
Brass wires



《铜丝》X5mm
Brass wires

Bend
弯曲

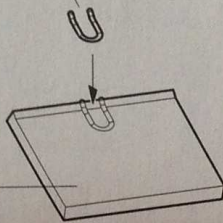

D13

制作2组
Make two

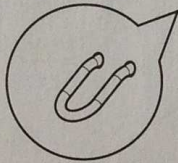

《铜丝》
Brass wires

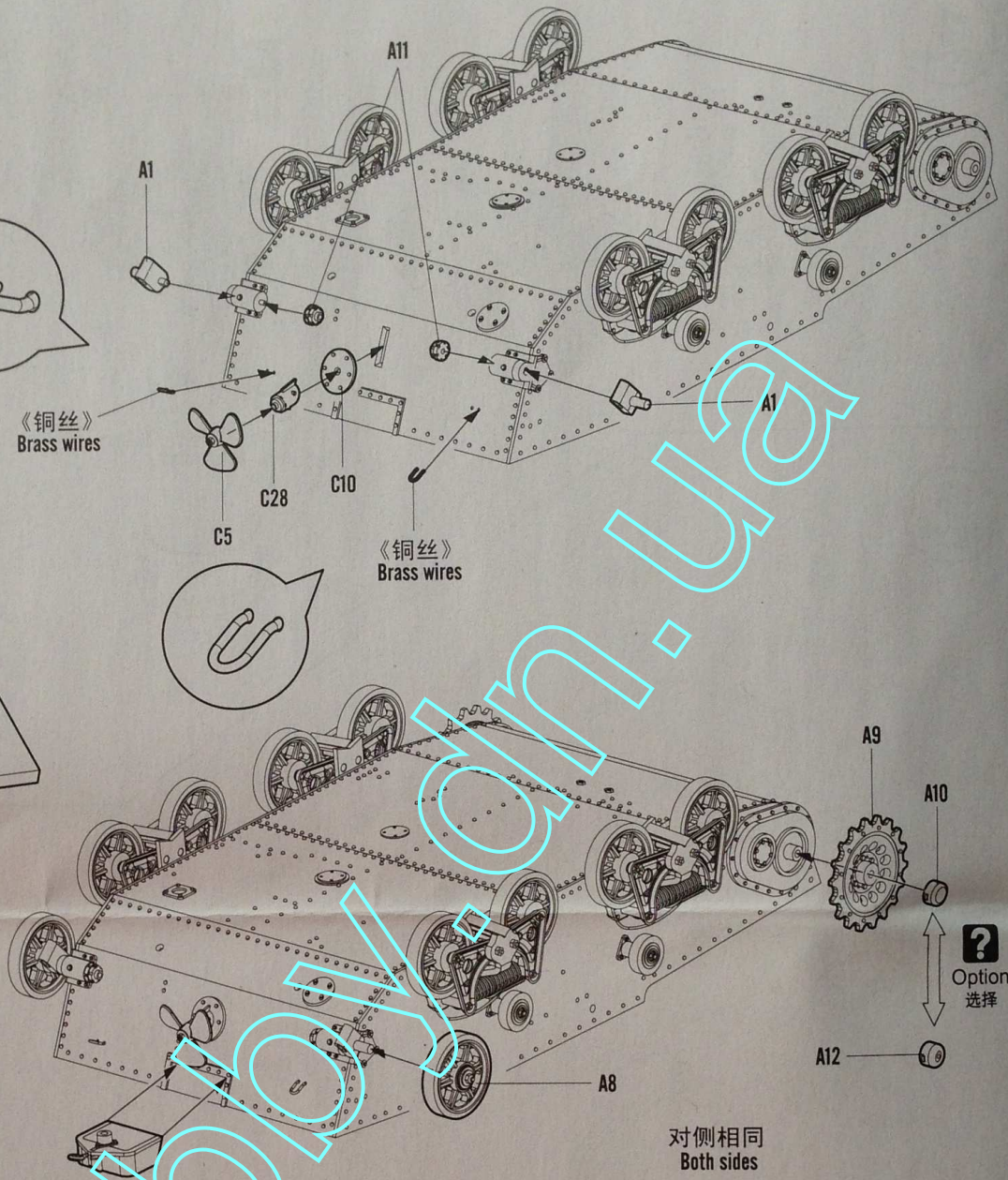

?
Option
选择

对侧相同
Both sides

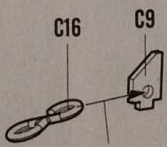

No cement
不涂胶水

C34

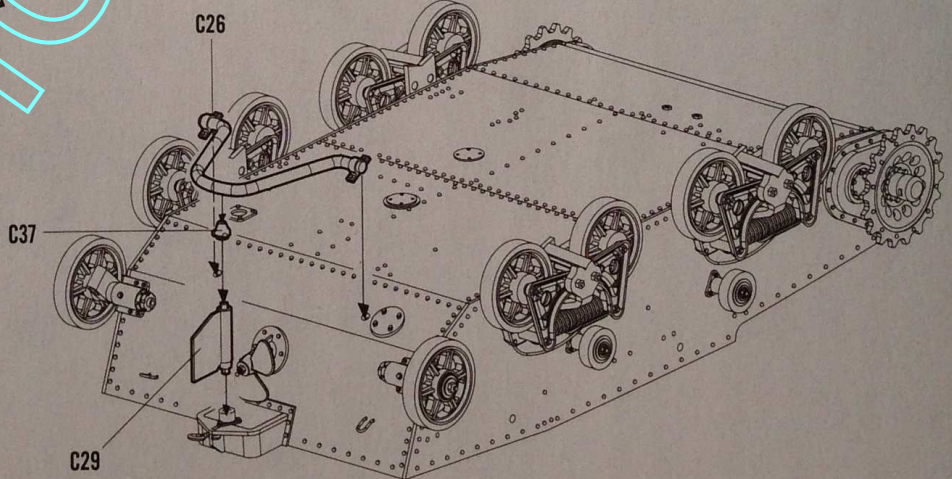



履带联接
Track construction

单侧履带需86节
Complete track for one side requires 86 links



制作2组
Make two

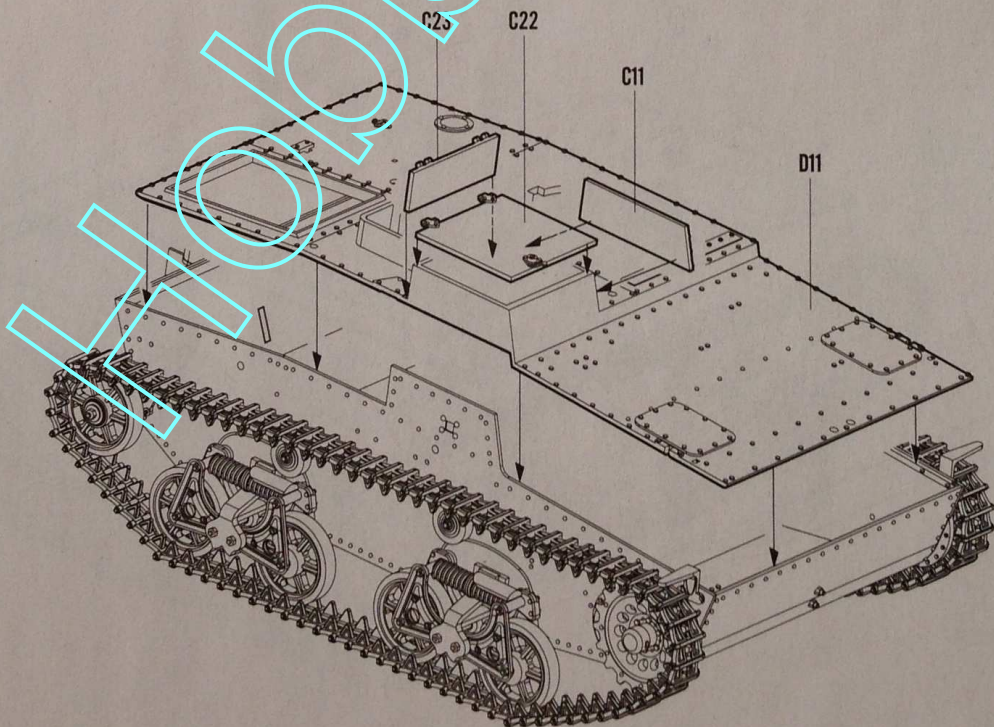
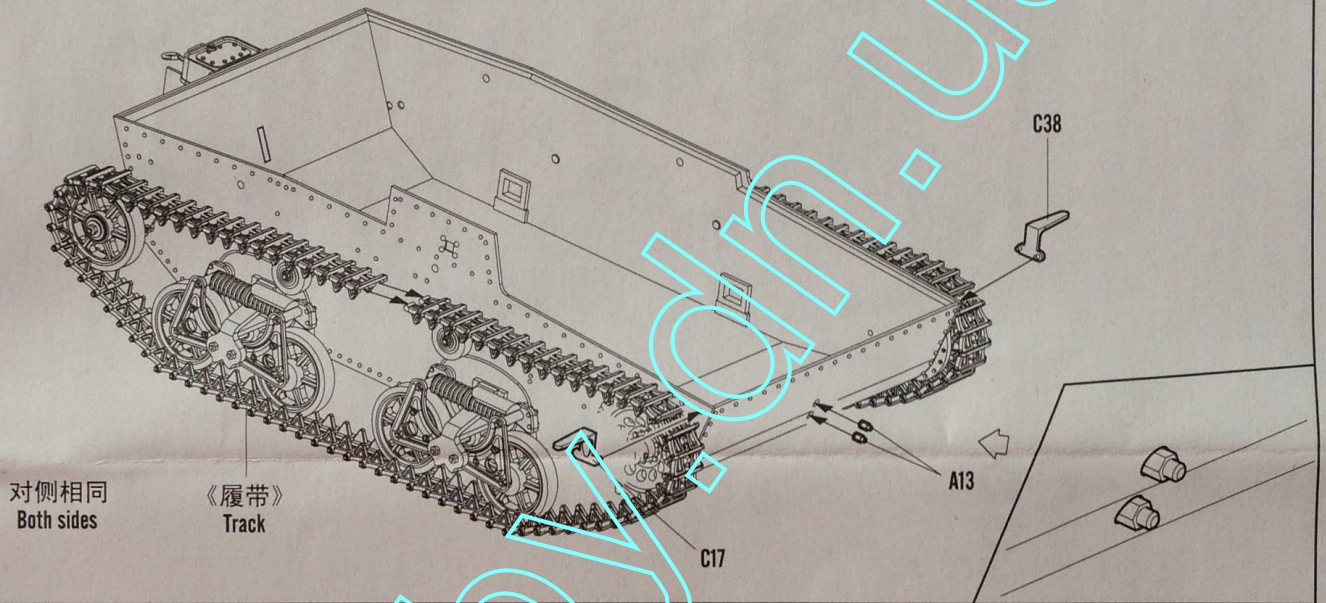

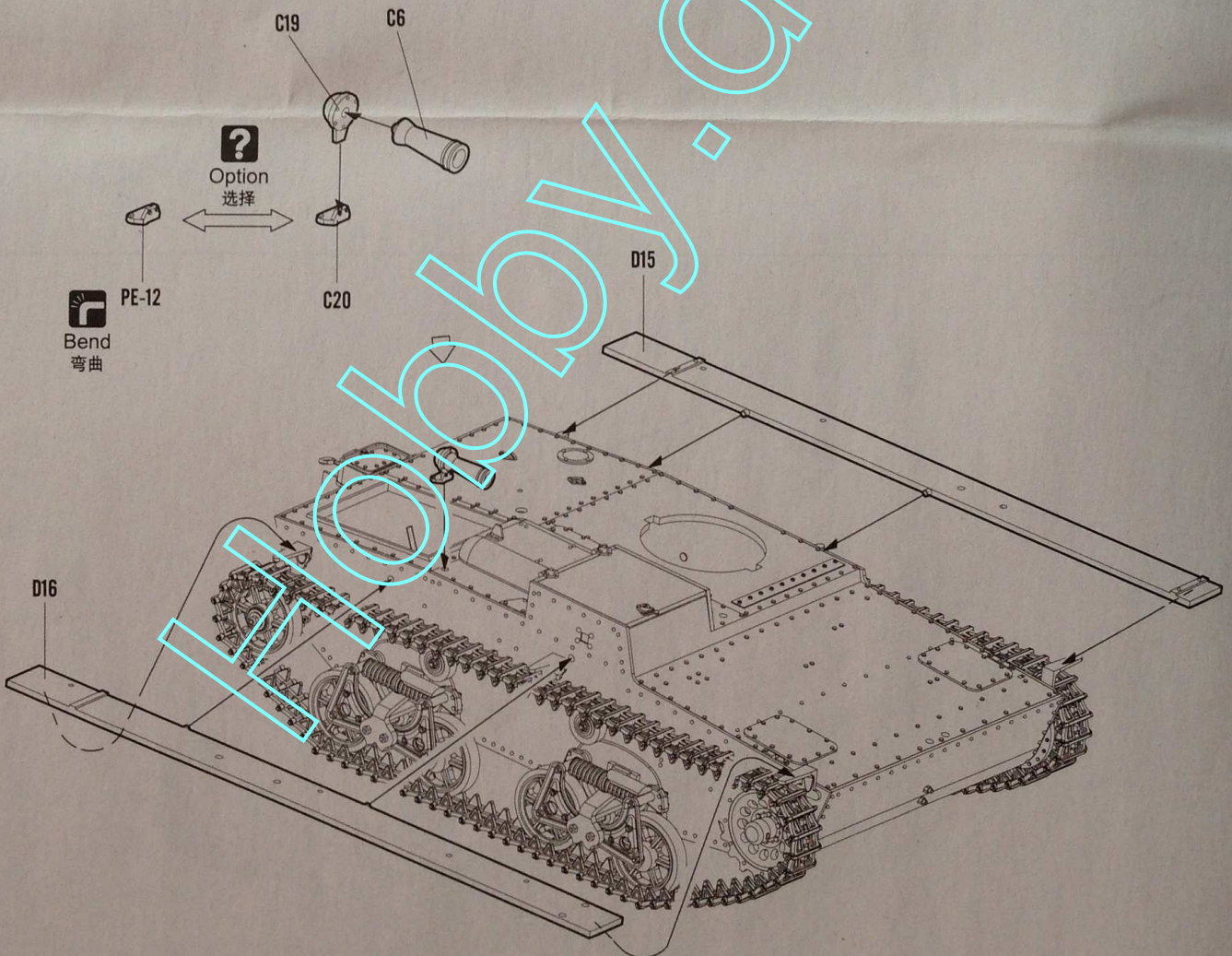
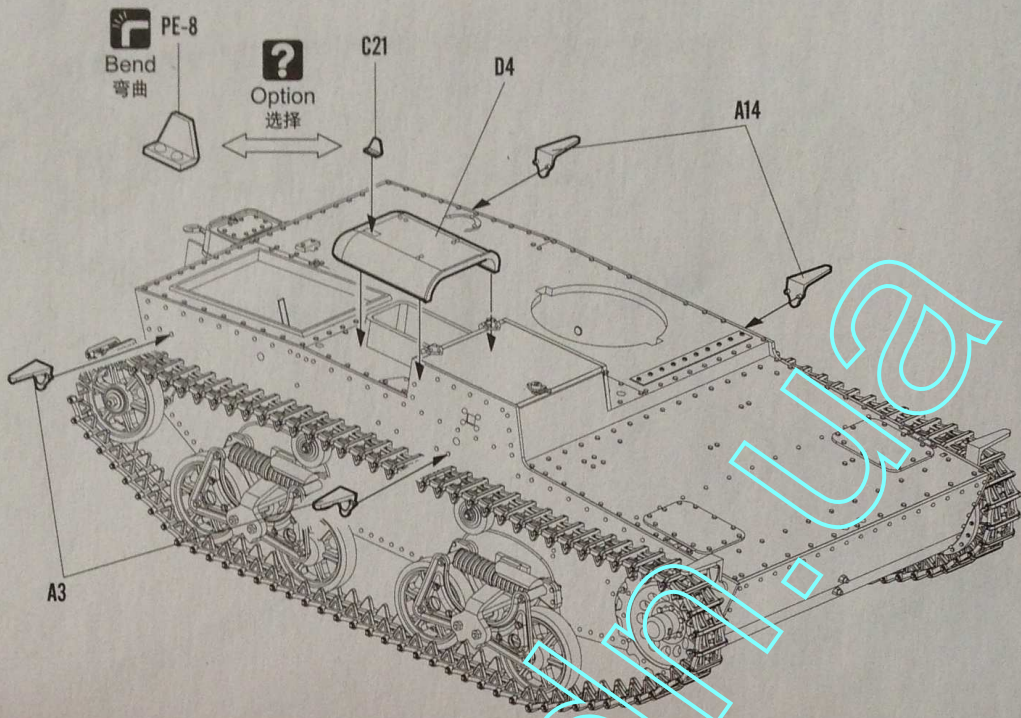

7
STEP

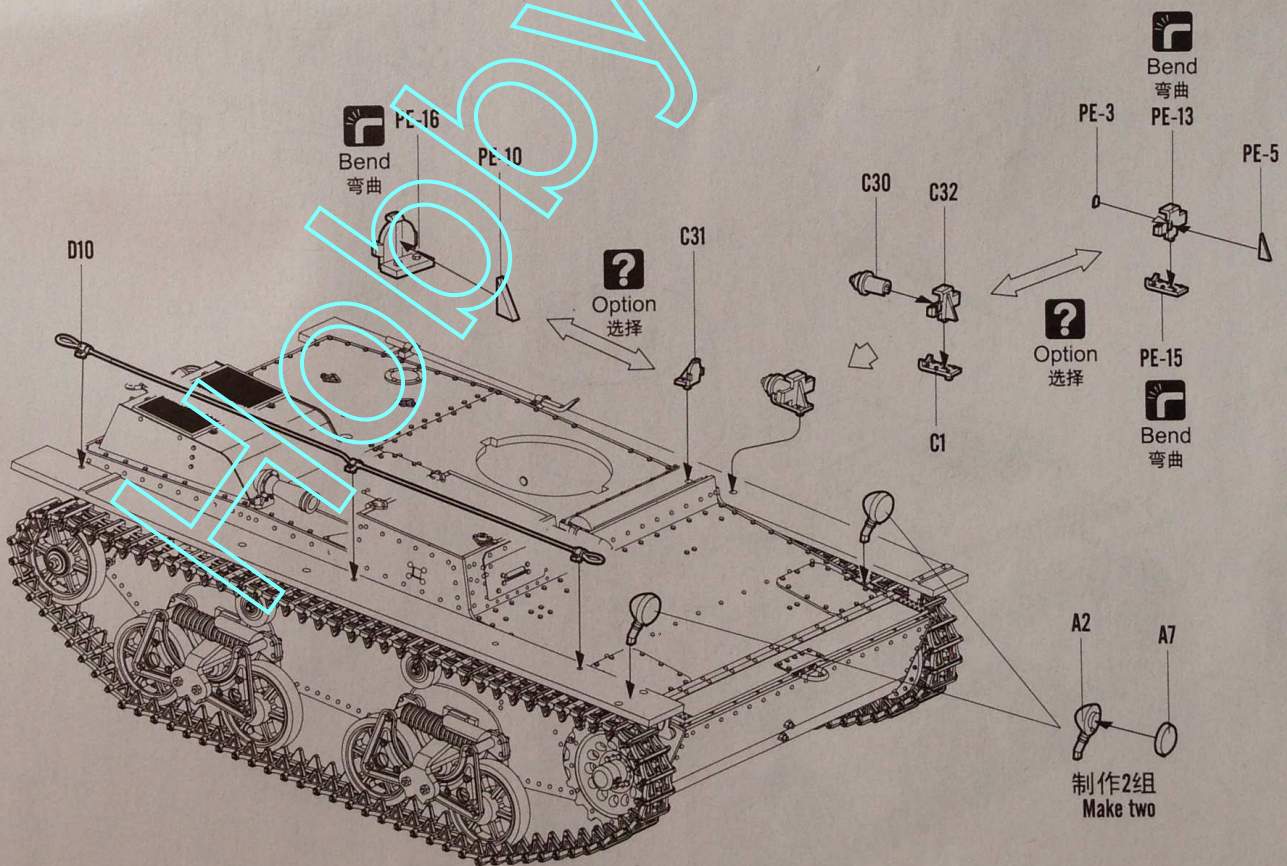
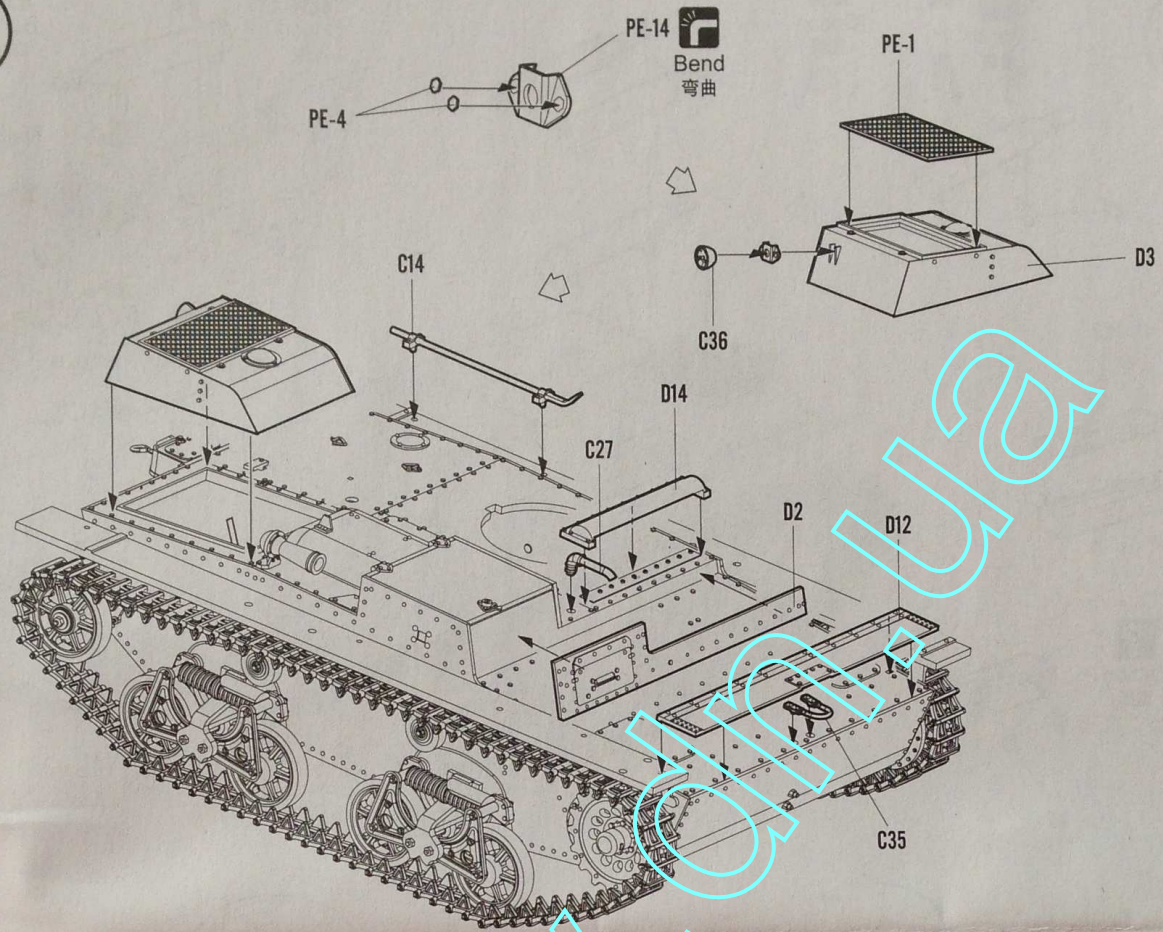



PE-6
Bend
弯曲

?
Option
选择

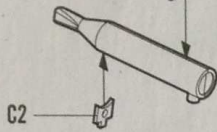
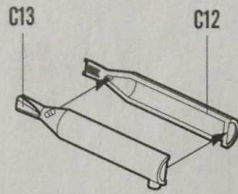

? PE
Option
选择

PE-6
Bend
弯曲

PE-11
Bend
弯曲

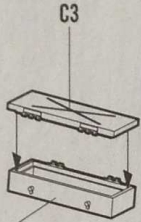
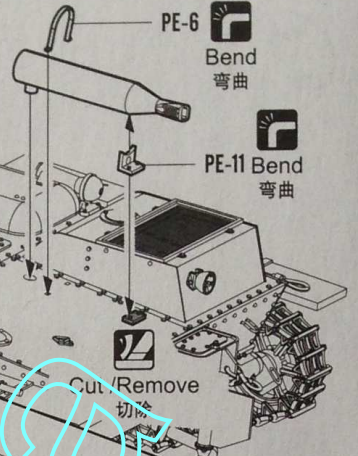

C4

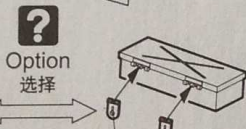

?
Option
选择

PE-7

A5

D1

C24

D17

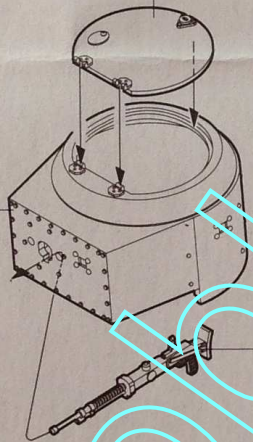

PE-2

C18

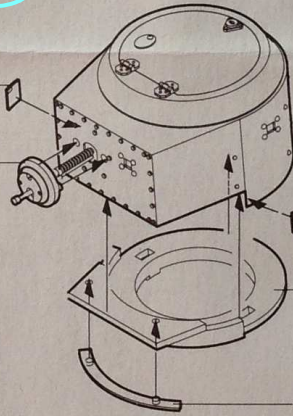

PE-2

D5

C15

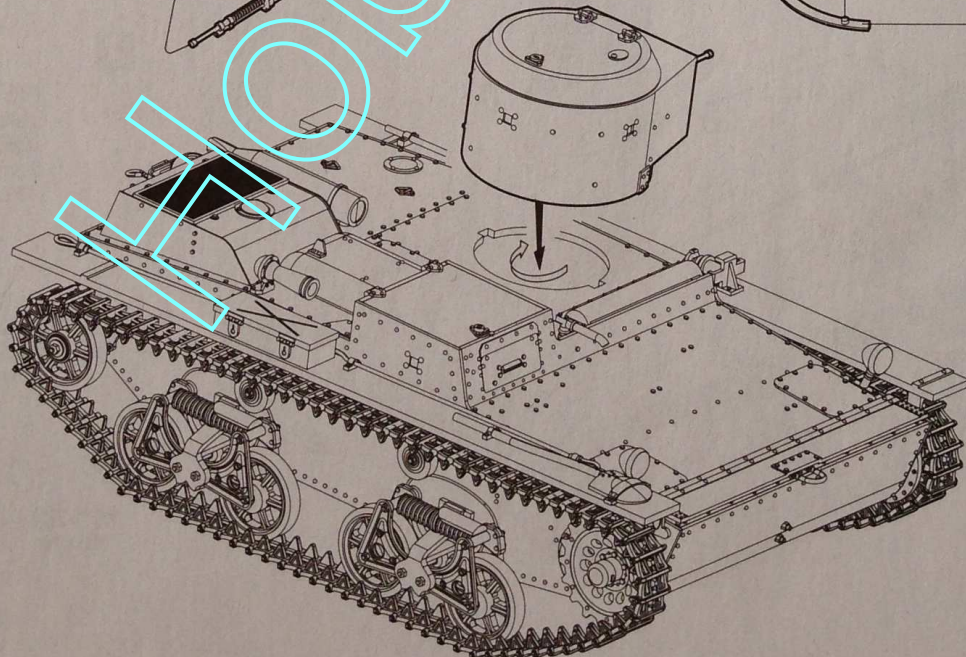

II

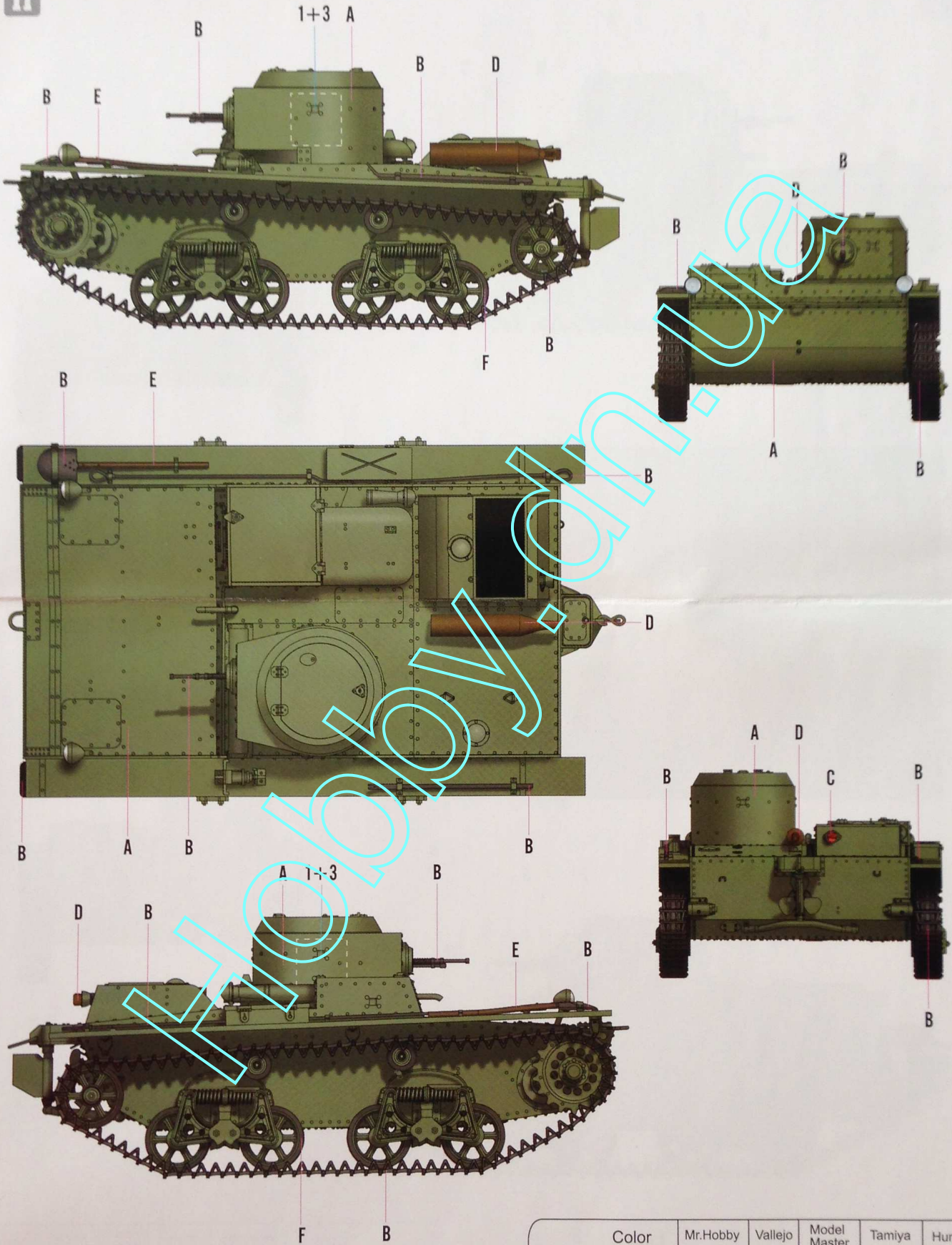

	Color	Mr.Hobby	Vallejo	Model Master	Tamiya	Humbrol
D	烧铁色 Burnt Iron	H 76 61	863	1795	X10	53
E	木棕色 Wood Brown	H 37 43	983	1701	--	186
F	胎黑色 Tire Black	H 77 137	--	--	--	--

NO.:83865

※ Some paints may not be available in your country. Please check your local hobby shop for substitute

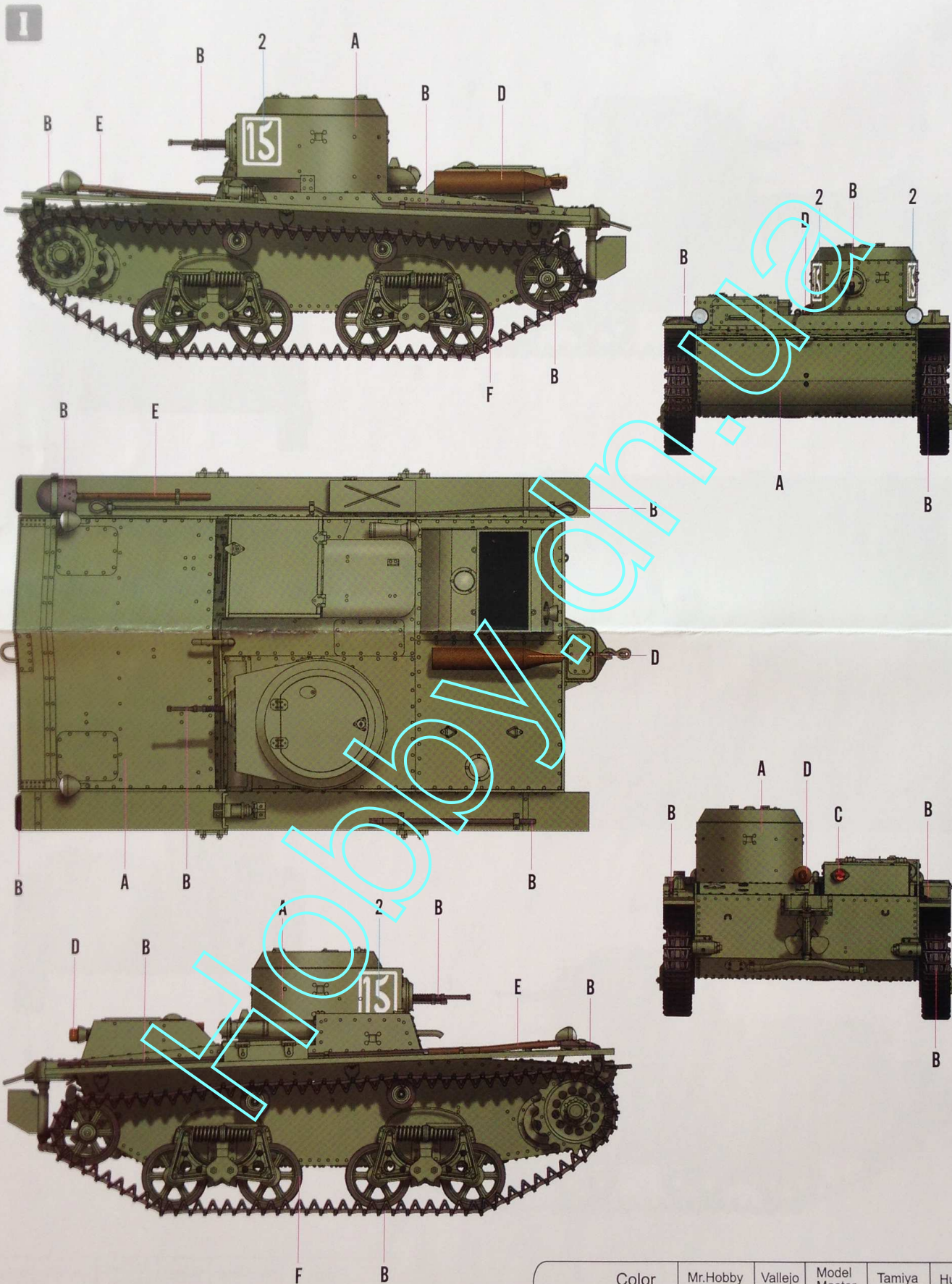

	Color	Mr.Hobby	Vallejo	Model Master	Tamiya	Humbrol
A	苏联绿 Russian Green(1)	H 136	--	--	--	--
B	黑铁色 Steel	H 18 28	864	1402	--	--
C	透明红 Clear Red	H 90 47	934	--	X27	--