

Pz.Kpfw.VIII MAUS

1:35 Scale Model Kit



Instruction & Painting Manual



HOBBY 2000
35003

PARTS

REMOVE ENTFERNEN WYCIĄC ODSTRANIĆ	RETIRER CORTAR SEPARARE	OPEN HOLE OFFNEN WYKONAC OTWÓR VYVRTAT OTVOR	FORO APERTO HACER AQUEIRO FAIRE UN TROU	CA GLUE CA KLEBER KLEJ CA CA LEPIDLO	COLLA CA PEGAMENTO CA COLLE CA
--------------------------------------------	-------------------------------	-------------------------------------------------------	-----------------------------------------------	-----------------------------------------------	--------------------------------------

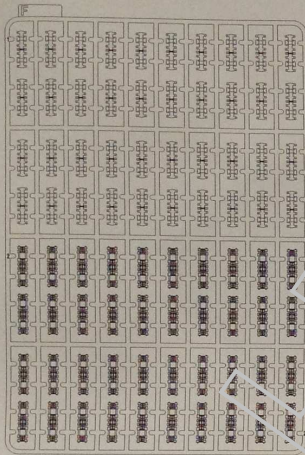

X3

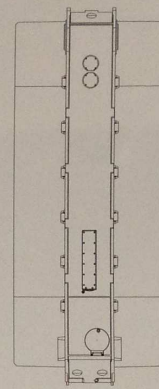
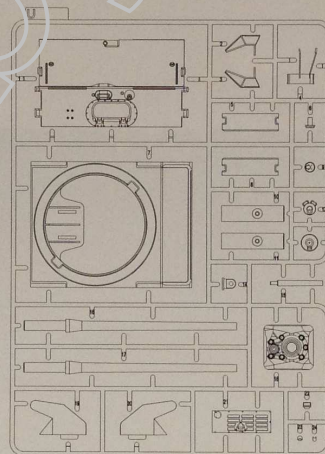
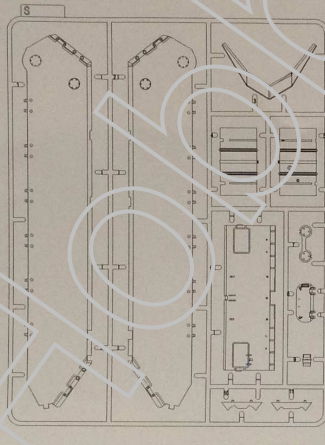

Lower Hull

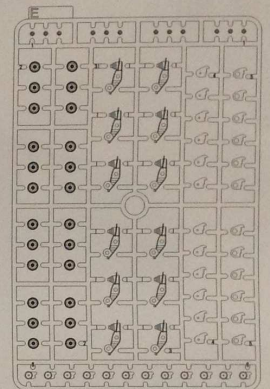

X2

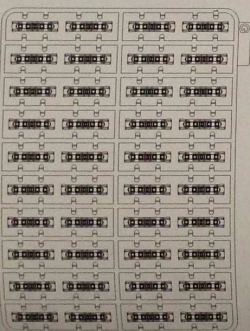

X3



TP

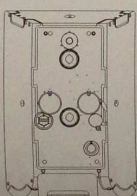

Turret

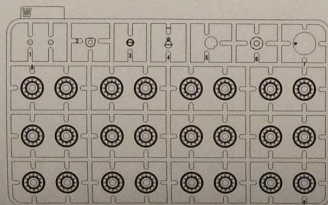

X2

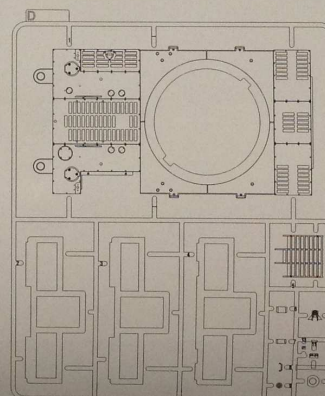

2

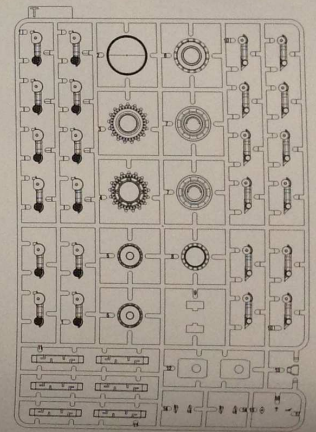

X2

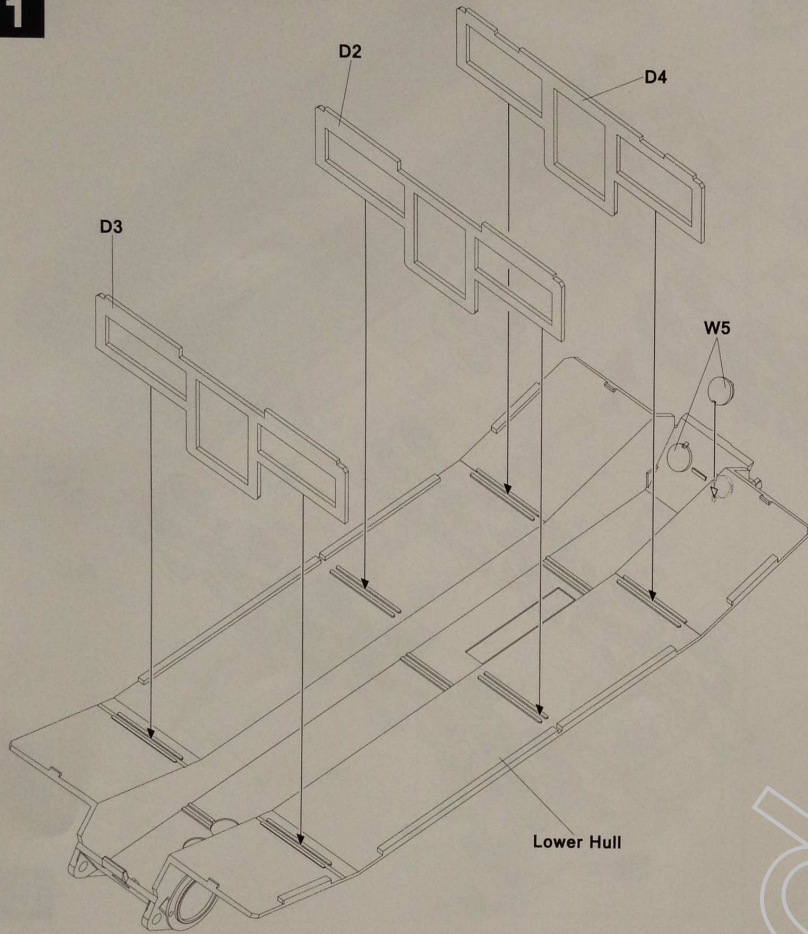
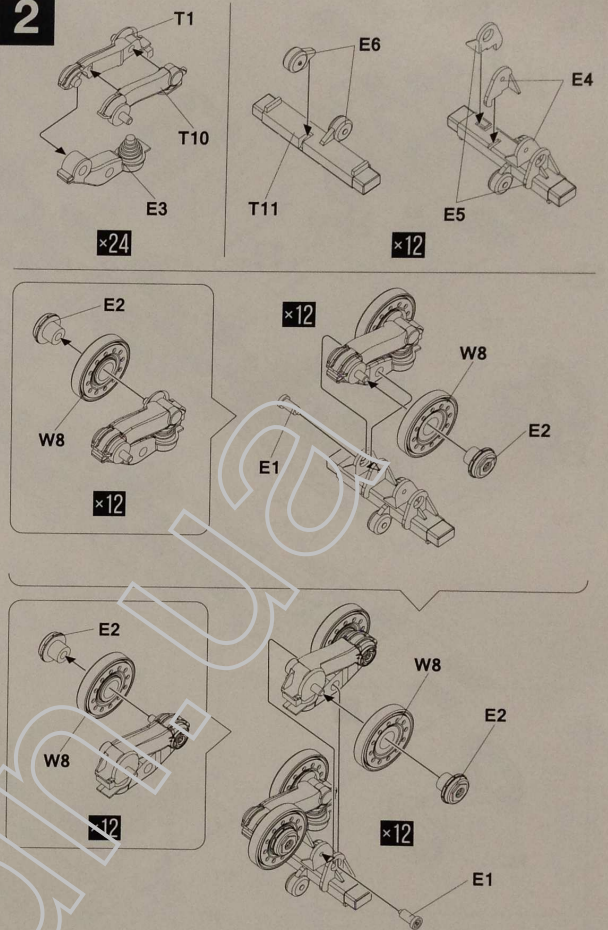
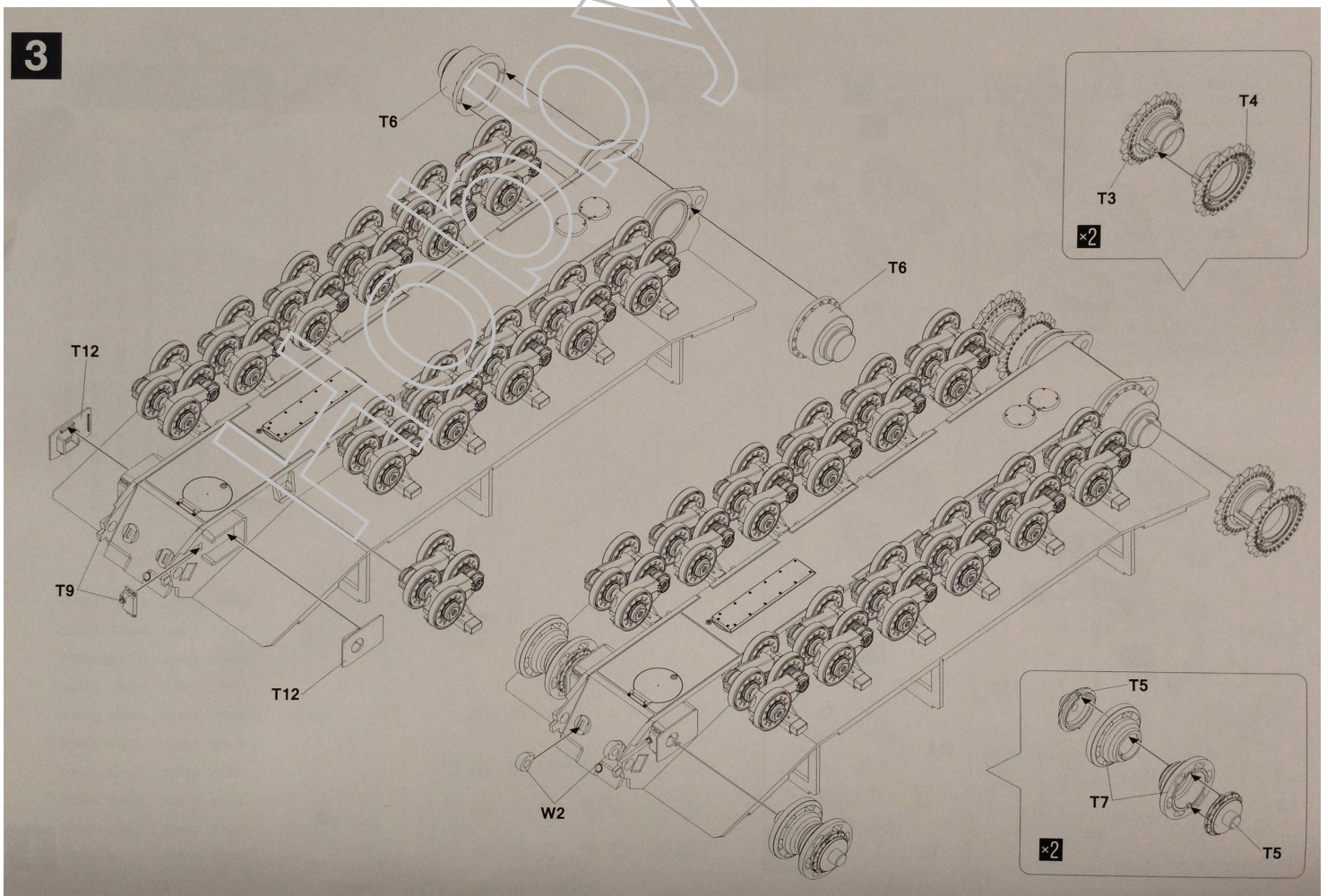
1**2****3**

4

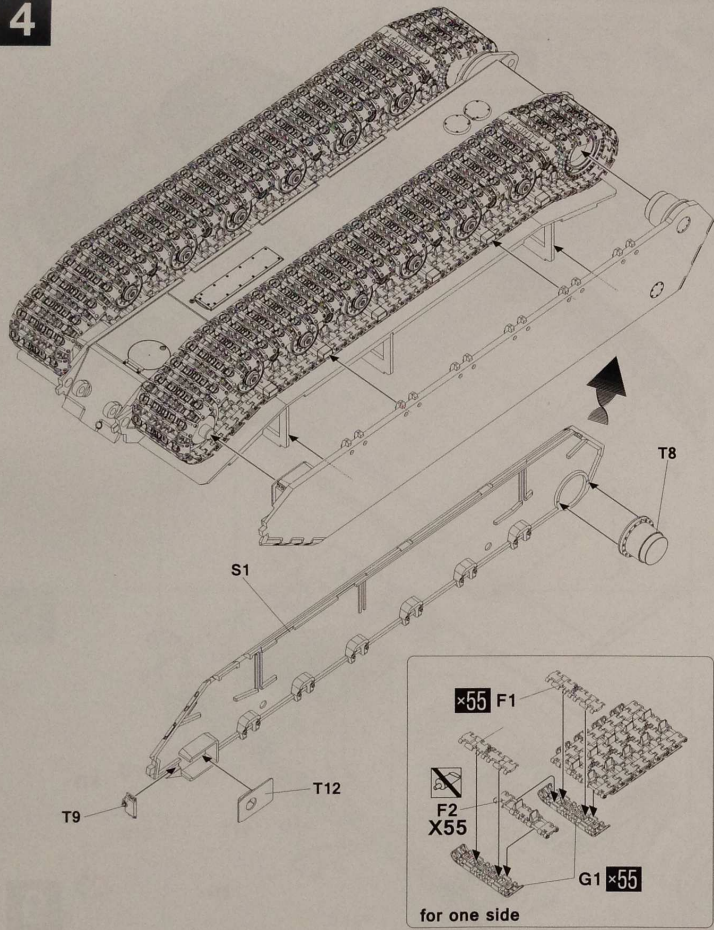

5

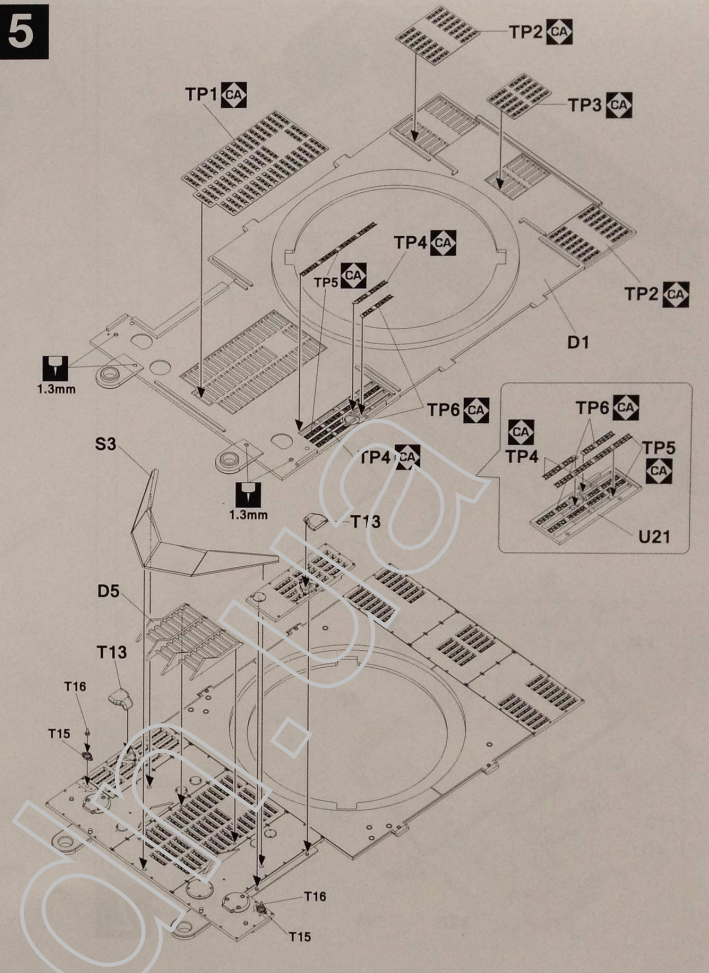

6

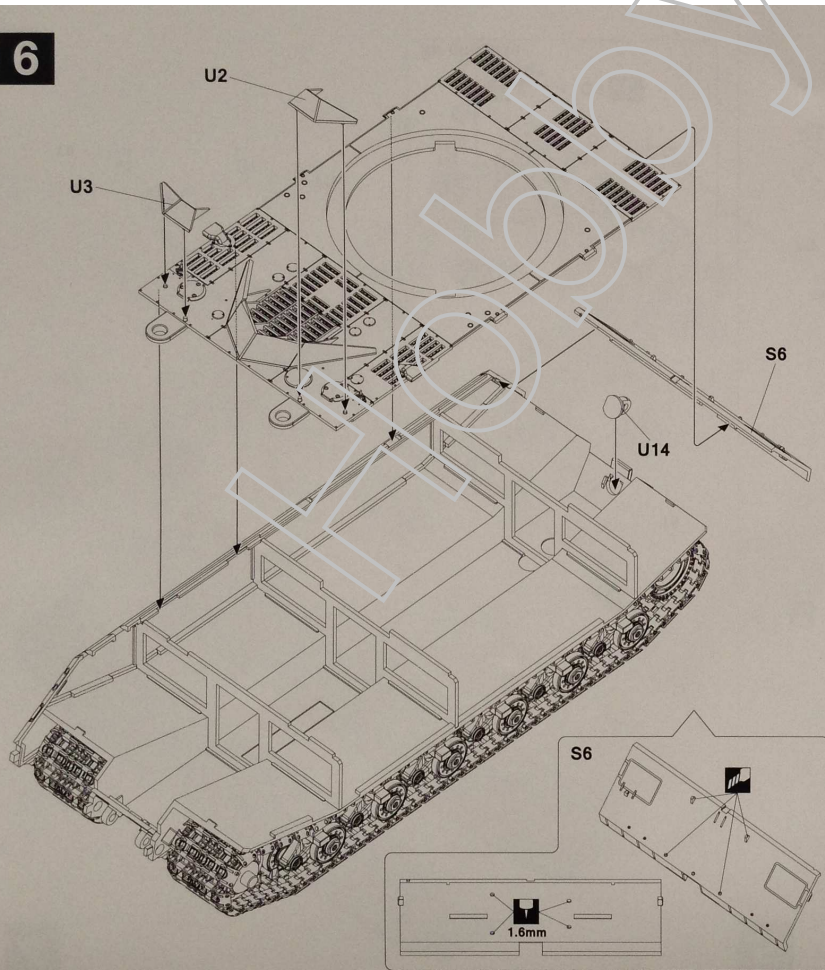

7

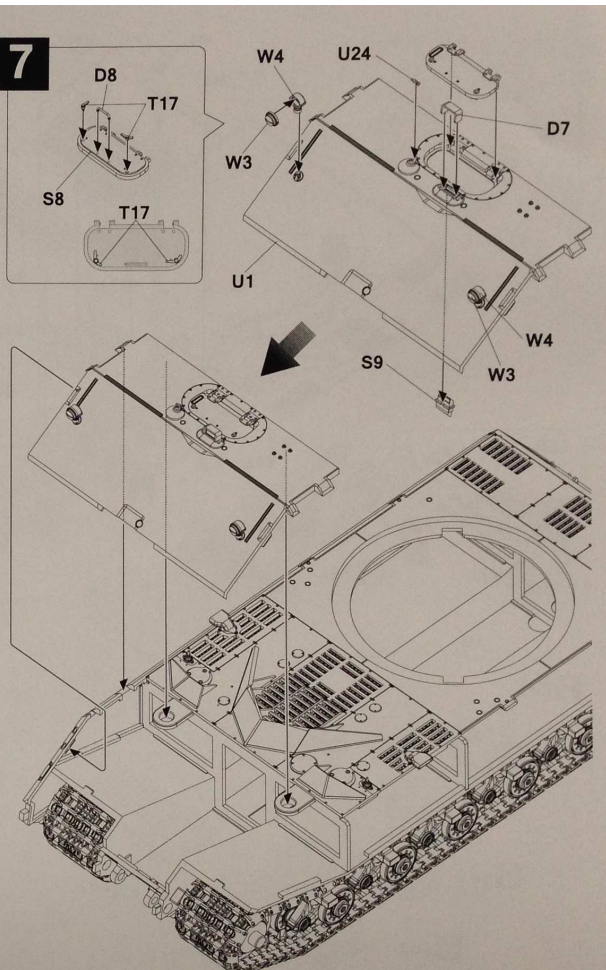

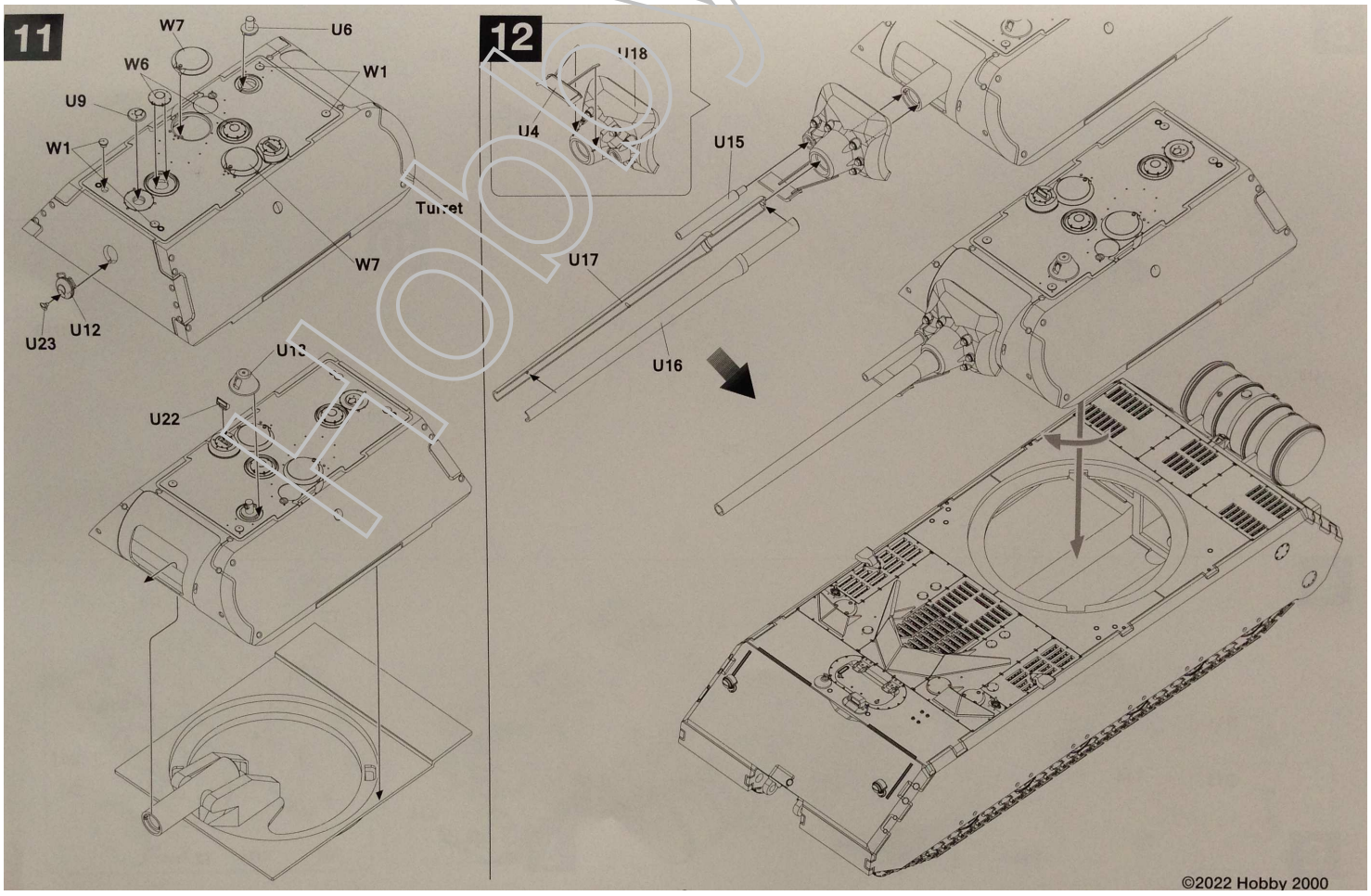
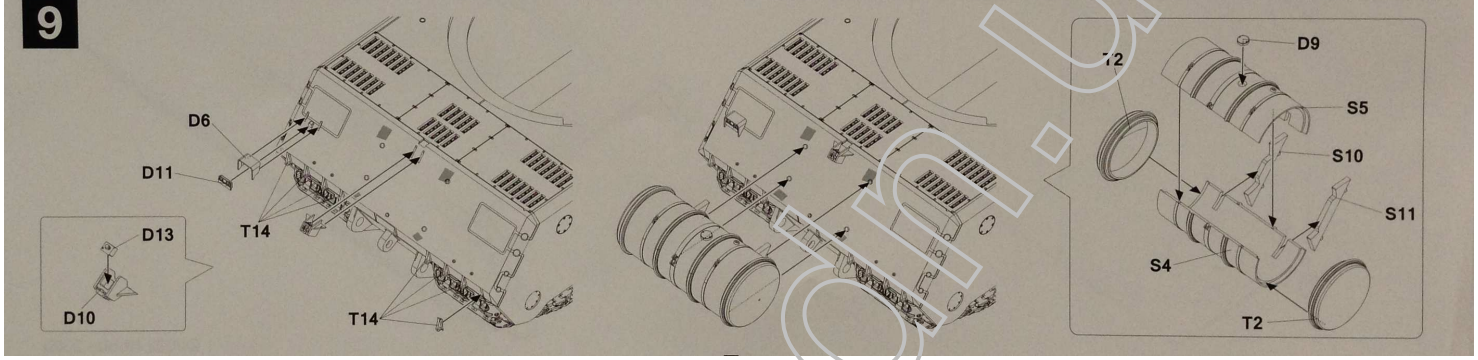
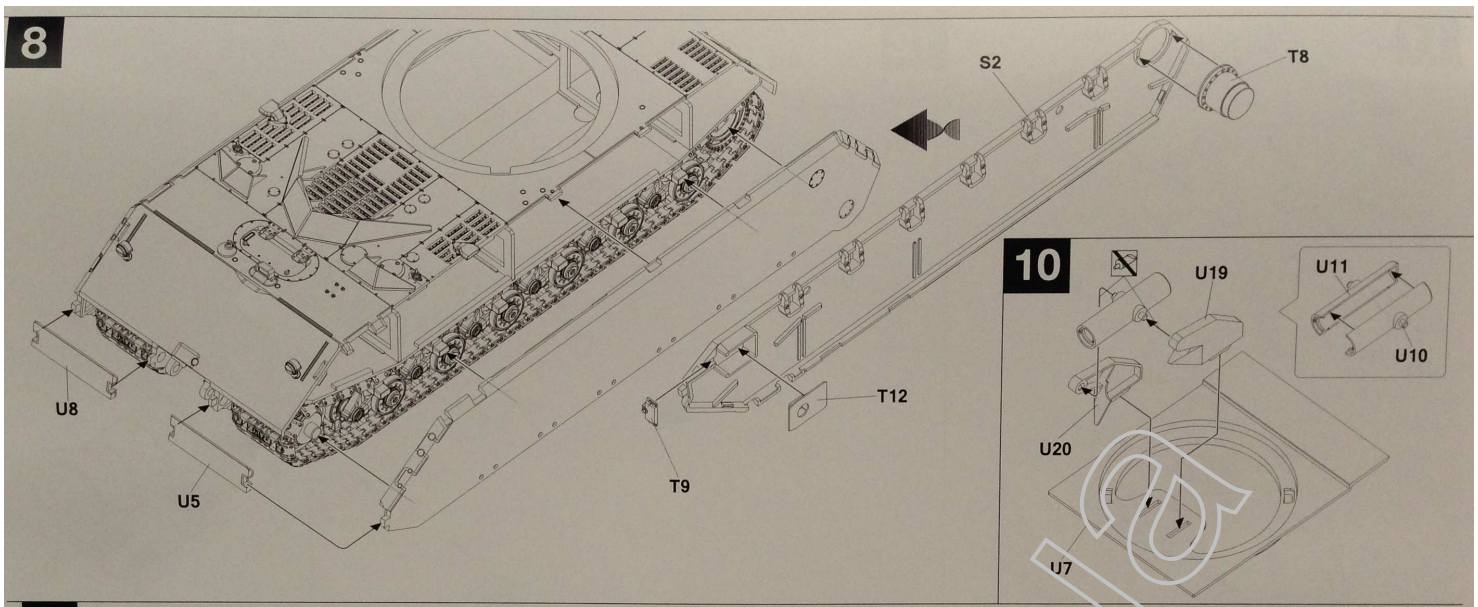

Pz.Kpfw.VIII MAUS

1:35 Scale Model Kit

Pz.Kpfw.VIII MAUS, Bobblingen, summer 1944

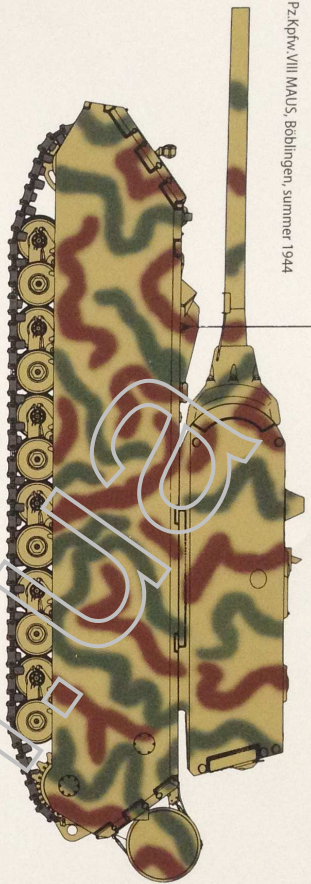

Pz.Kpfw.VIII MAUS, late 1945

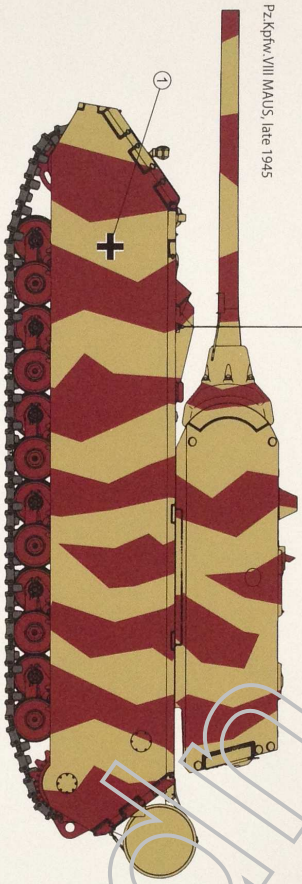

Pz.Kpfw.VIII MAUS, schwere Pz.Abt. 505, late 1945

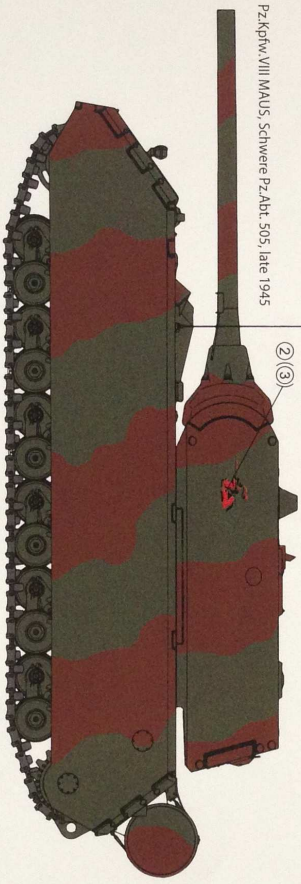

Pz.Kpfw.VIII MAUS, summer 1945

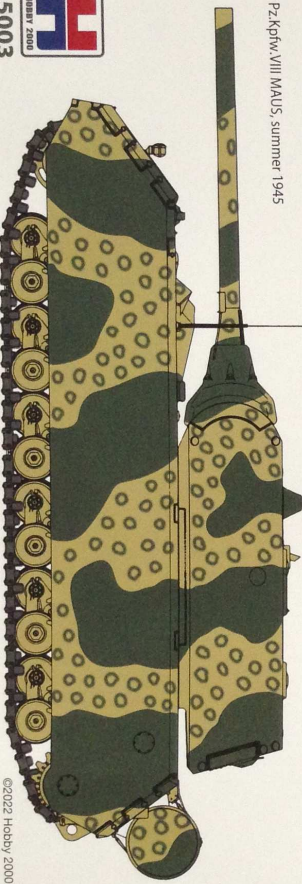

Color Chart	Mt. COLOR	TAMIYA	AMMO	AK Interactive	HATKA
Dunkelgelb 7028	A 039	XF-88	012	RC061	250
Olivgrün 6003	B 054	XF-89	001	RC047	169
Rotbraun 8017	C 041	XF-90	014	RC068	147
Rotbraun 8012	D 043	XF-64	920	RC067	175



35003

©2022 Hobby 2000

Hobby