

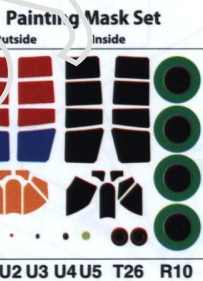

# P-40N

## Aces of 49th Fighter Group

### 48001

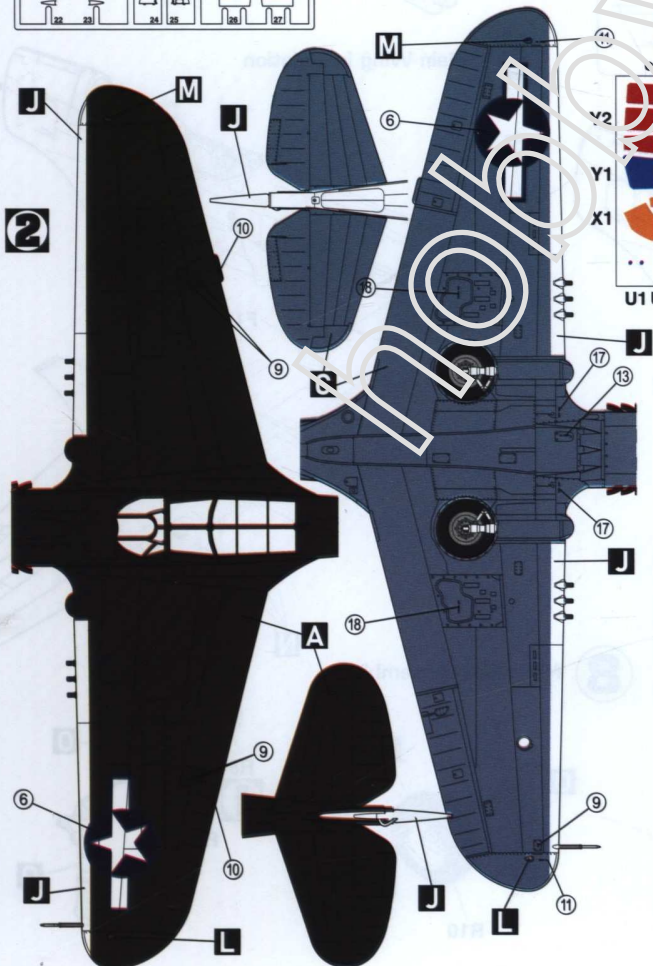
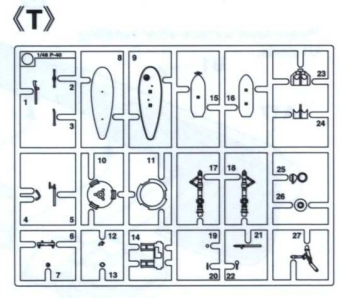
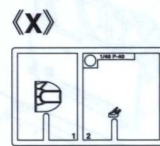
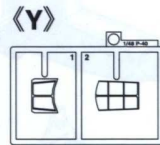
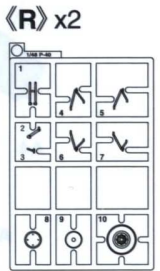
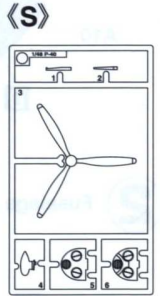
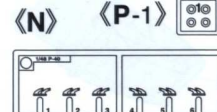
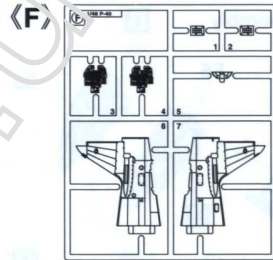
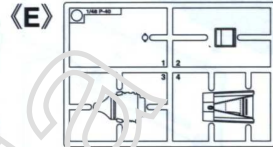
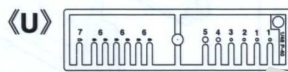
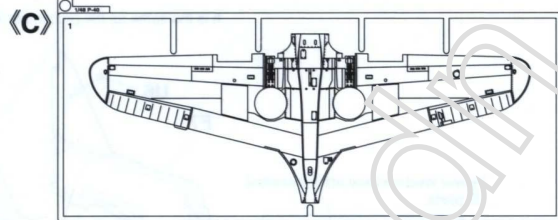
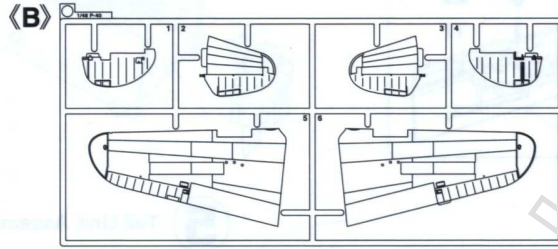
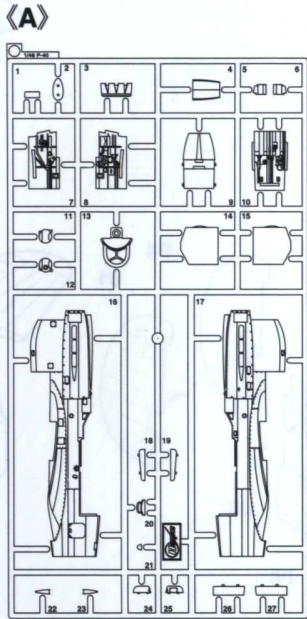
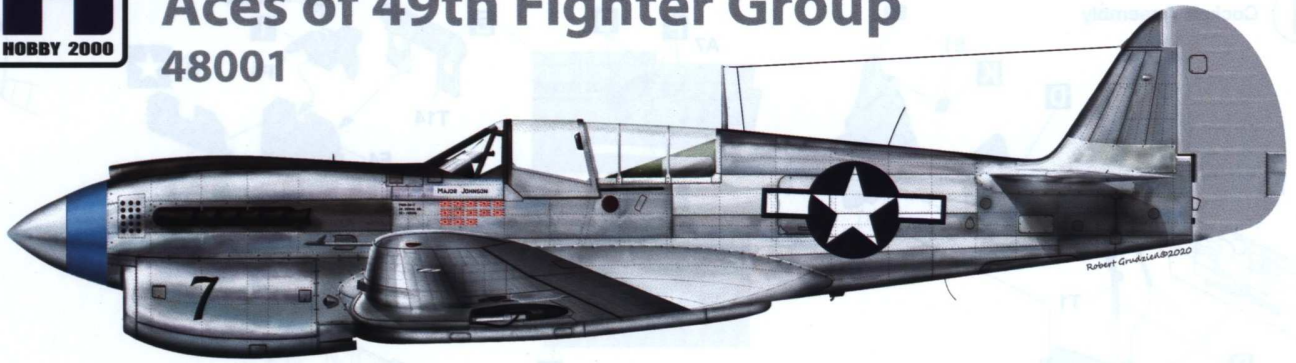

- OPEN HOLE  
FORO APERTO  
OFFNEN  
HACER AGUJERO  
WYKONAC OTWOR  
FAIRE UN TROU  
VYVRTAT OTVOR
- DECAL  
DECALCOMANIE  
ABZIEHBILD  
CALCOMANIA  
KALKOMANIA  
DECALCOMANIE  
OBTISK
- REMOVE  
RETIERER  
ENTFERNEN  
CORTAR  
WYCIAC  
SEPARARE  
ODSTRANIT
- DO NOT CEMENT  
NE PAS COLLER  
NICHT KLEBEN  
NO PEGAR  
NIE SKLEJAC  
NON INCOLLARE  
NELEPT
- OPTION  
FACULTATIF  
NACH BELIEBEN  
HACER AGUJERO  
DO WYBORU  
FACOLTATIVO  
VOLBA

Color Chart	AK Interactive	Alciad2	AMMO	HATAKA	Mr. COLOR	TAMIYA
Olive Drab 41	A RC 259	E617	926	018	304	XF-62
Aluminium	B RC 020	119	194	078	MC-218	XF-16
Neutral Grey 43	C RC 261	E660	239	033	013	XF-53
Yellow Green	D RC 262	E309	220	211	C027	XF-4
Yellow	E RC 007	E658	032	104	004	X-8
Red	F RC 005	E657	049	103	033	X-7
Burnt Metal	G RC 015	121	187	016	061	XF-84
Medium Green 42	H RC 260		238	019	302	XF-58
Flat Black	I RC 001	E102	046	100	033	XF-1
Flat White	J RC 004	101	050	101	062	XF-2
Leather	K AK-3031	302	133	186	044	XF-10
Clear Red	L RC 503	401	093	CC02	047	X-27
Clear Blue	M RC 504	403	098	CC01	050	X-23
Steel	N AK-670	112	191		028	X-11
Silver	O RC 020	112	195	189	008	X-11
Blue	P RC 011	E640	123	220	314	XF-8



**ASSEMBLY INSTRUCTION**    **Bauanleitung**    **Instructions de Montage**    **Instrucciones de Montaje**  
**Istruzioni di Assemblaggio**    **Instrukcja Montażu**    **Montážní Instrukce**

**1 Cockpit Assembly**

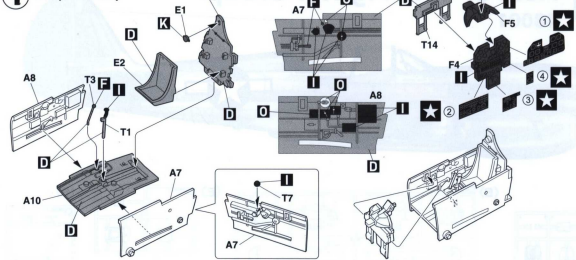

**2 Fuselage Assembly**

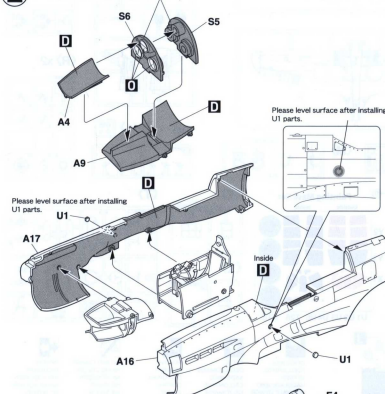

**3 Exhaust Stacks Installation**

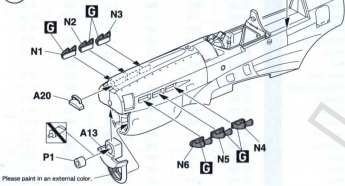

**5 Tail Unit Assembly**

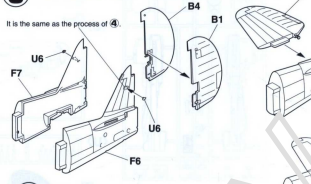

**6 Main Wing Installation**

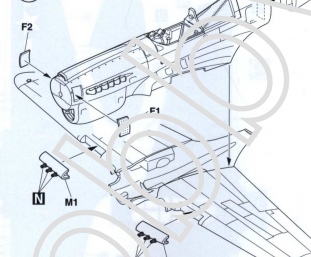

**8 Main Gear Assembly**

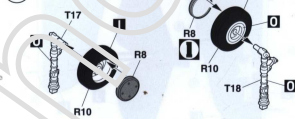

**4 Main Wing Assembly**

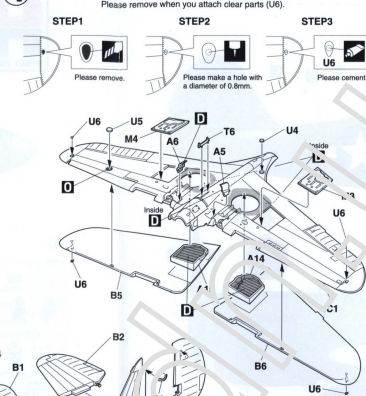

**9 各部分の取り付け**

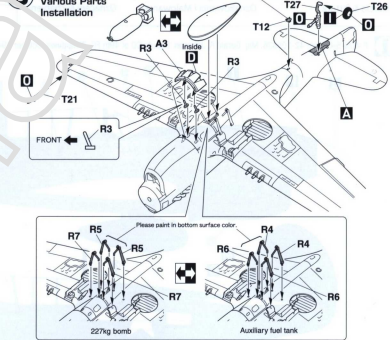

**10 Main Gear Installation**

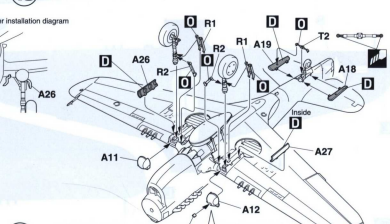

**7 Auxiliary Fuel Tank & Bomb Assembly**

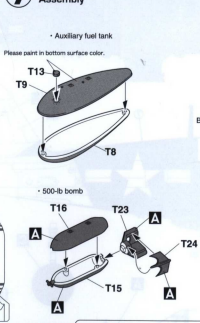

**11 Propeller Assembly**

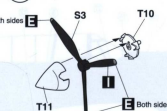

**12 Final Assembly**

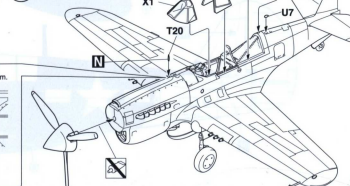

**MARKINGS AND PAINTING**  
 Marcio & Pittura

Markierungen und Bemalung  
 Oznakowania i Malowanie

Decoration et Peinture  
 Označeni & Zbarveni

Decoracion y Pintura

**1** P-40N-5-CU, s/n 42-105826, Maj. Gerald R. Johnson, Deputy CO of 49th FG, Philippines, October 1944

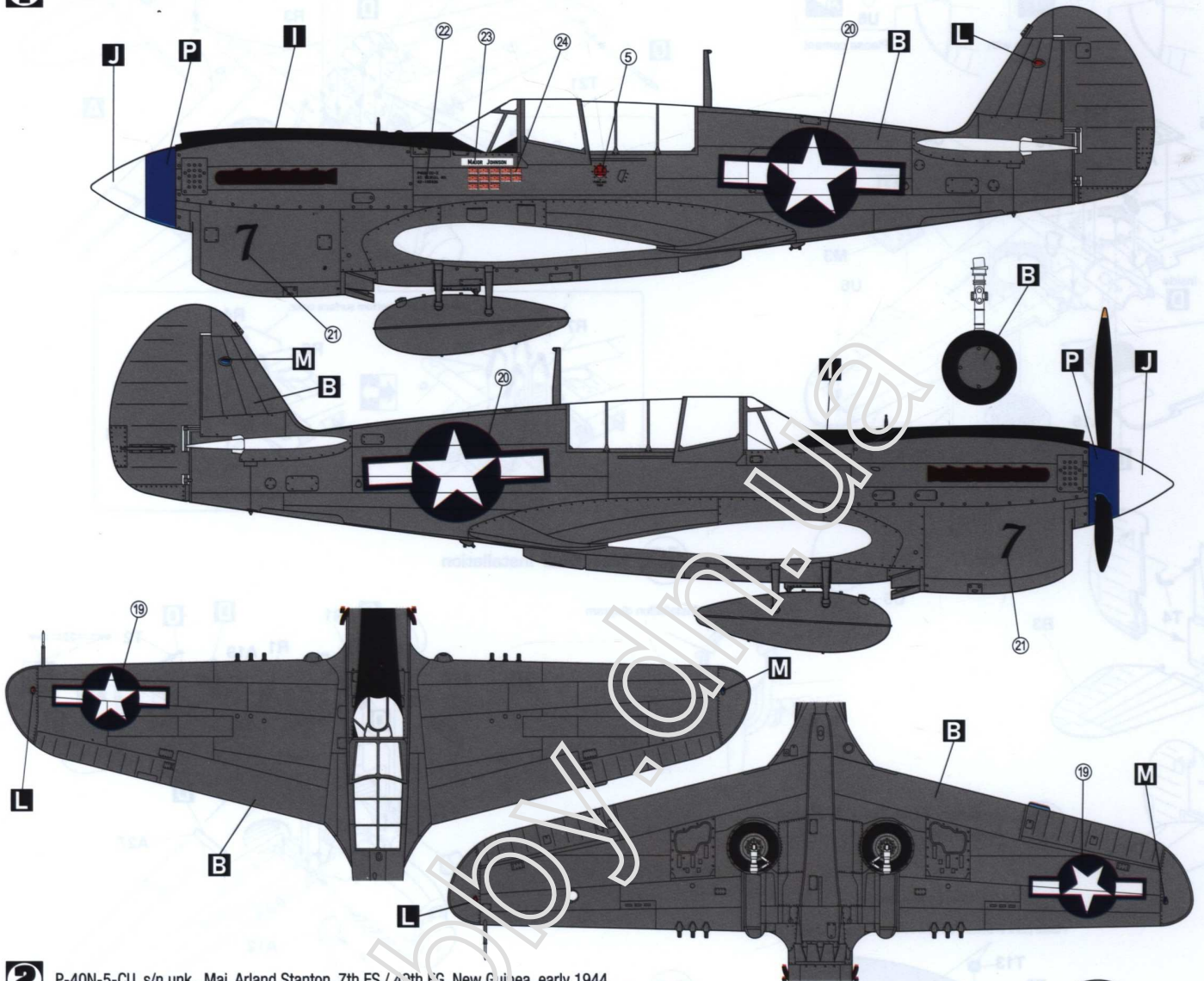

**2** P-40N-5-CU, s/n unk., Maj. Arland Stanton, 7th FS / 49th FG, New Guinea, early 1944

