

Plastic model  
scale 1/72

# Roland D II

## Pfalz D II

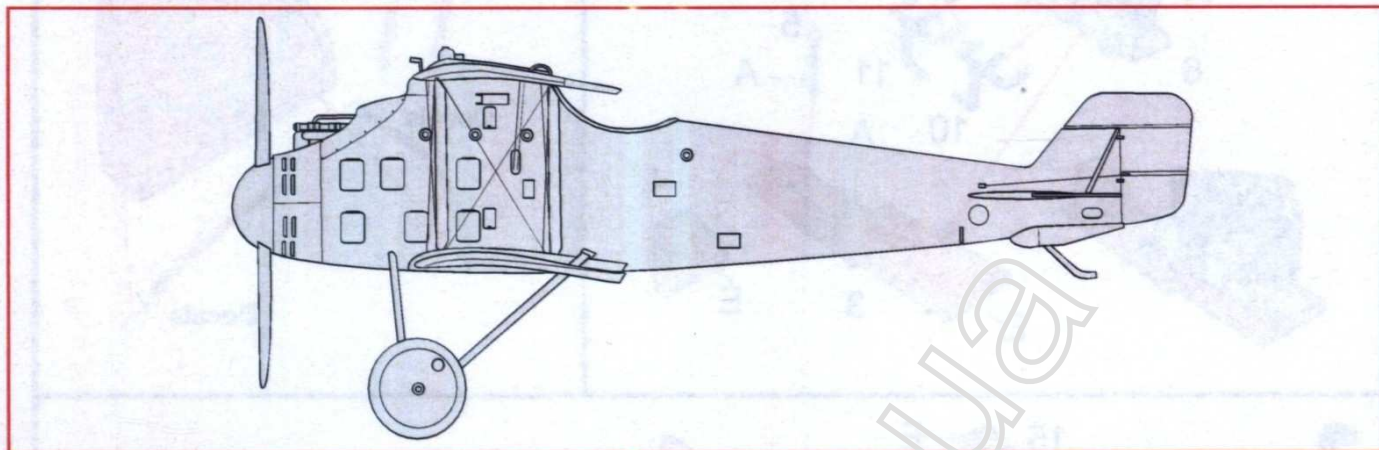

### Historie / History

[https://en.wikipedia.org/wiki/LFG\\_Roland\\_D.II](https://en.wikipedia.org/wiki/LFG_Roland_D.II)

### Plastikové díly - Plastic parts

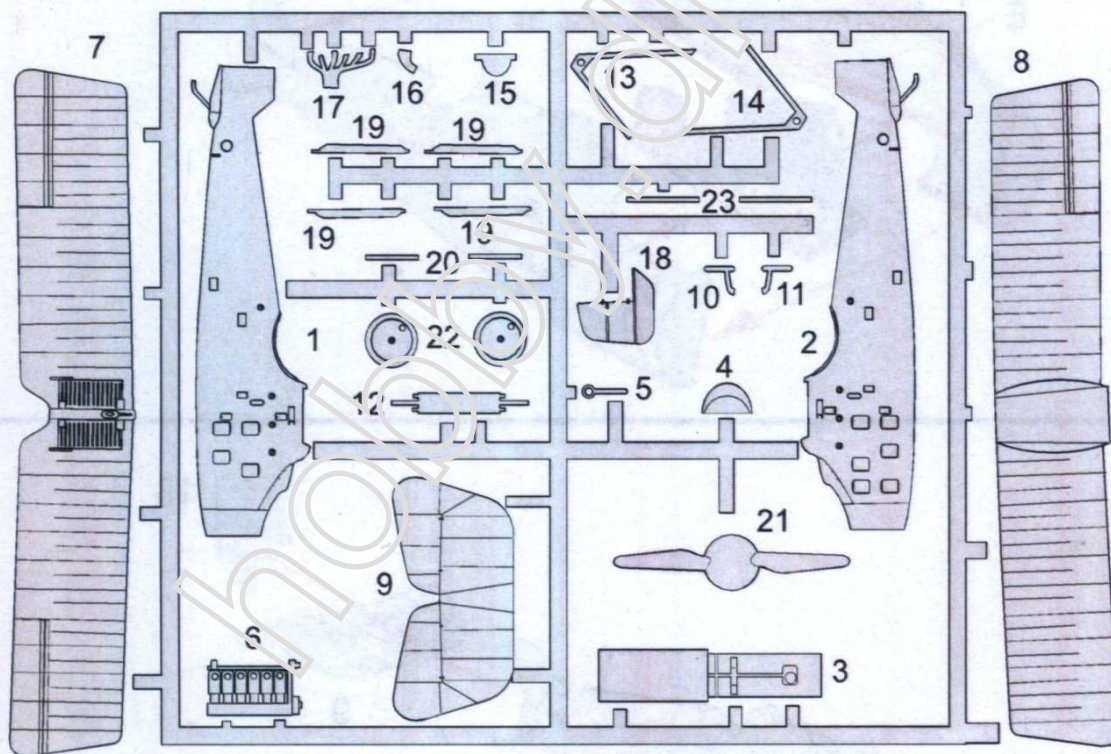

Používejte pouze vhodné nářadí, lepidlo a barvy. Během práce nejezte a nepijte.  
POZOR - obsahuje malé součásti, které mohou mít ostré hrany. Není vhodné pro děti.

Use proper tools, glue and paints. Do not eat and drink during the work.  
WARNING - contains small parts with possible sharp edges. Not suitable for children.

  
VOLITELNÉ  
OPTIONAL

  
VYVRTAT  
DRILL HOLE

  
ZBROUSIT  
REDUCE

  
ODSTRANIT  
REMOVE

Colour name	Humbrol	Colour name	Humbrol
A Black	H33	G Aluminium	H56
B White	H34	H Silver	H11
C Light Blue	H106	I Linen	H74
D Light Grey	H64	J Red	H132
E Wood	H110	K Tyre	H85
F Yellow	H24	L Rust	H113

Stavební postup - Assembly instructions

1

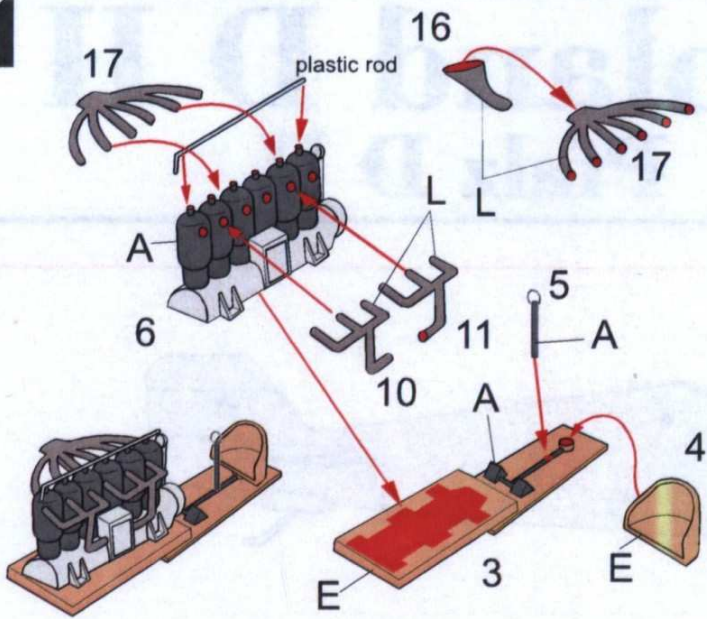

2

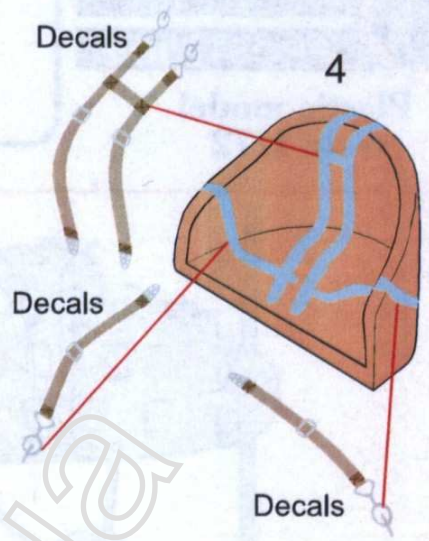

3

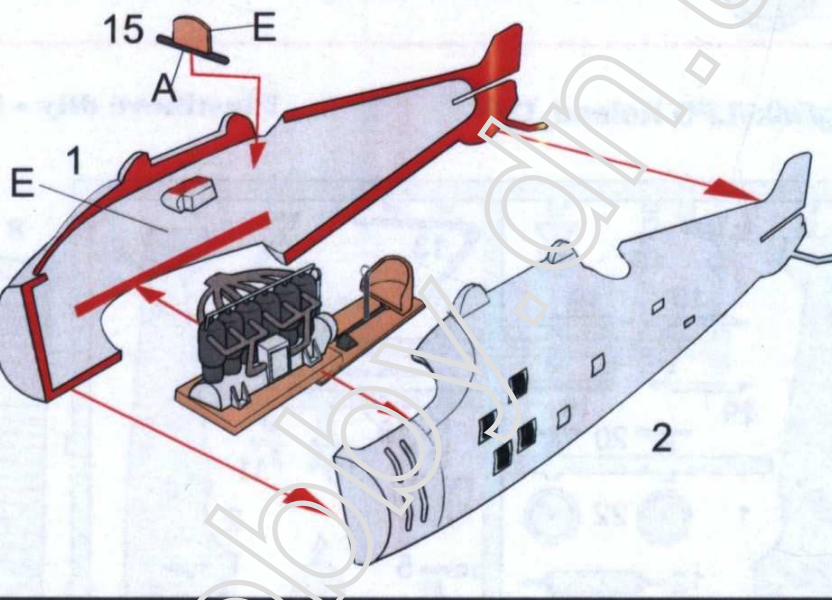

4

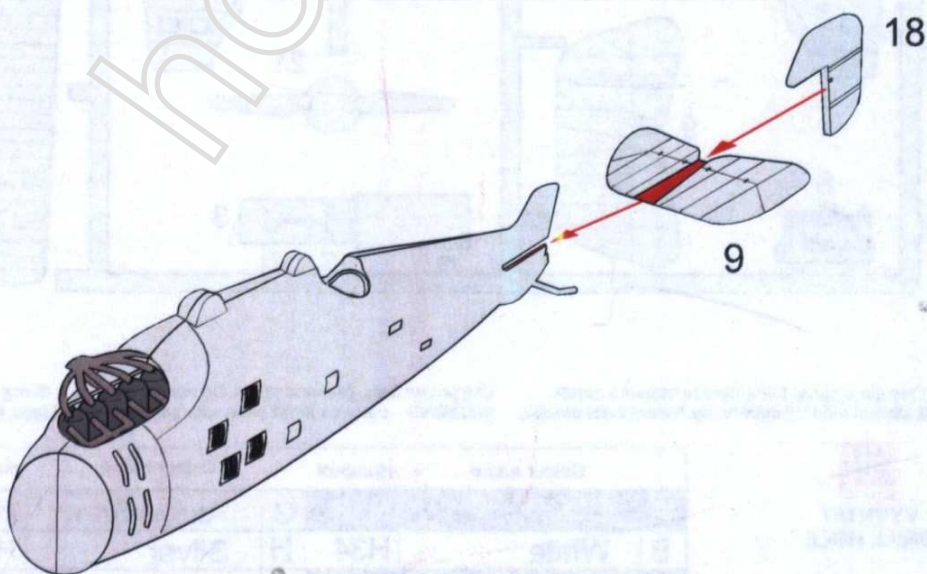

5

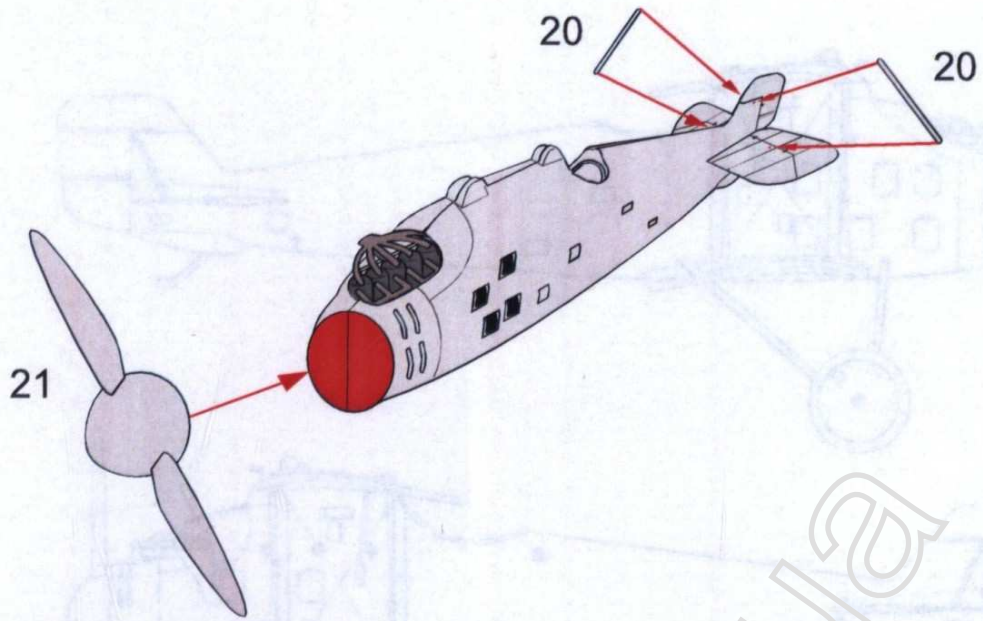

6

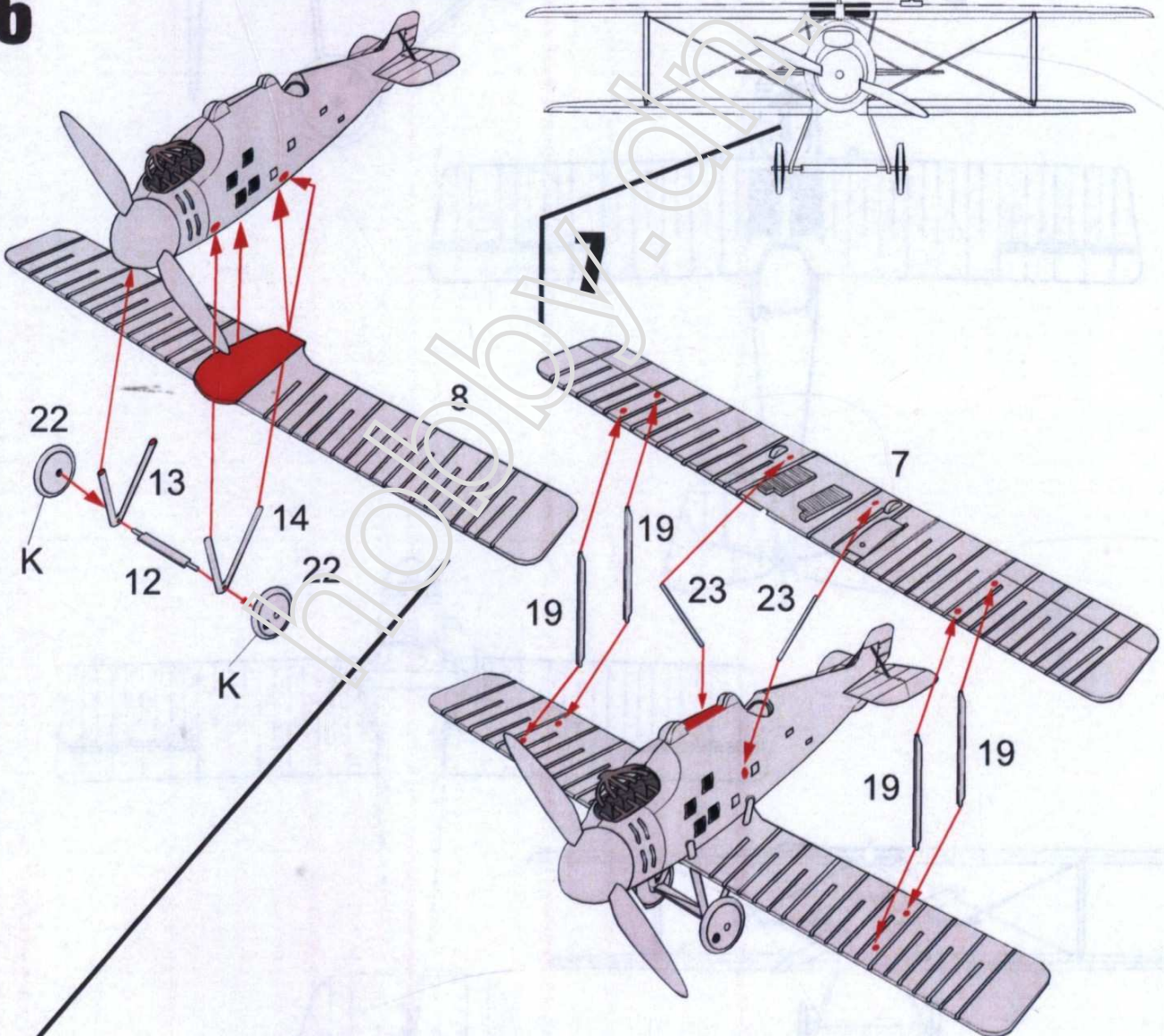

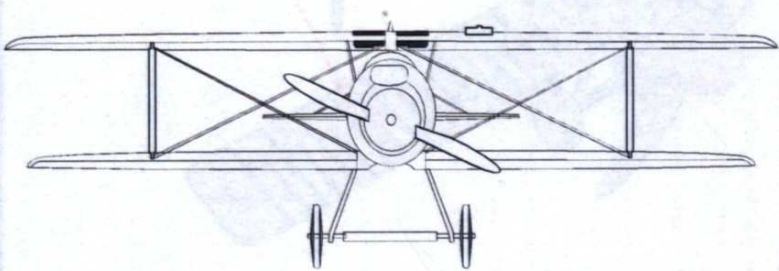
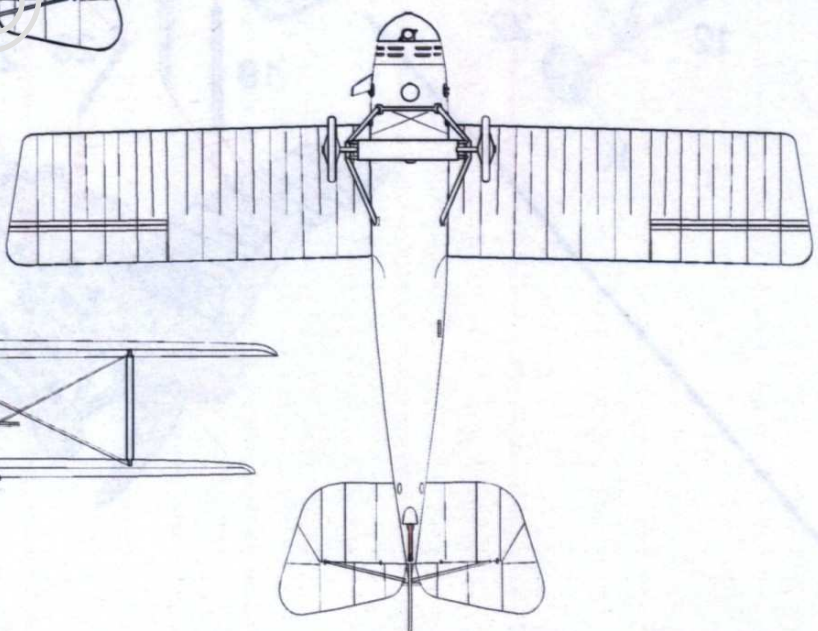
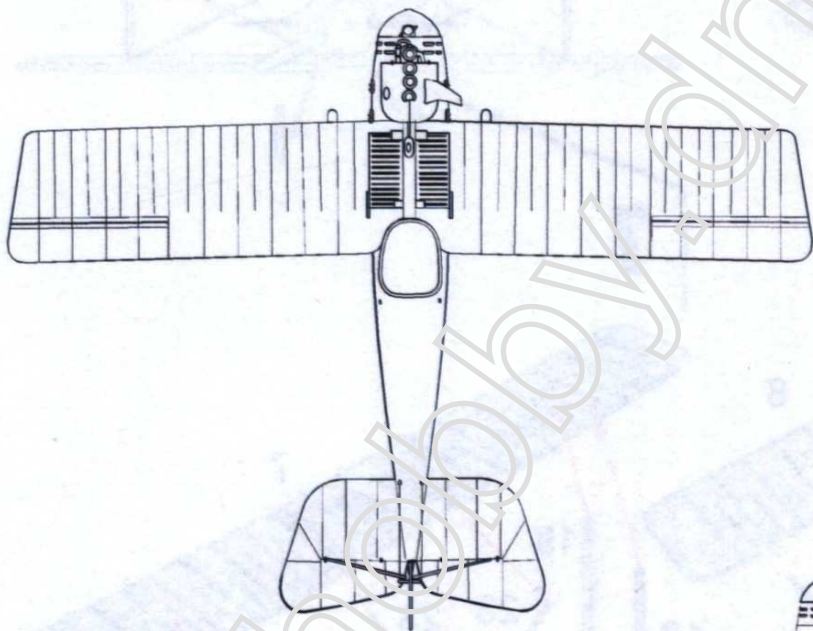
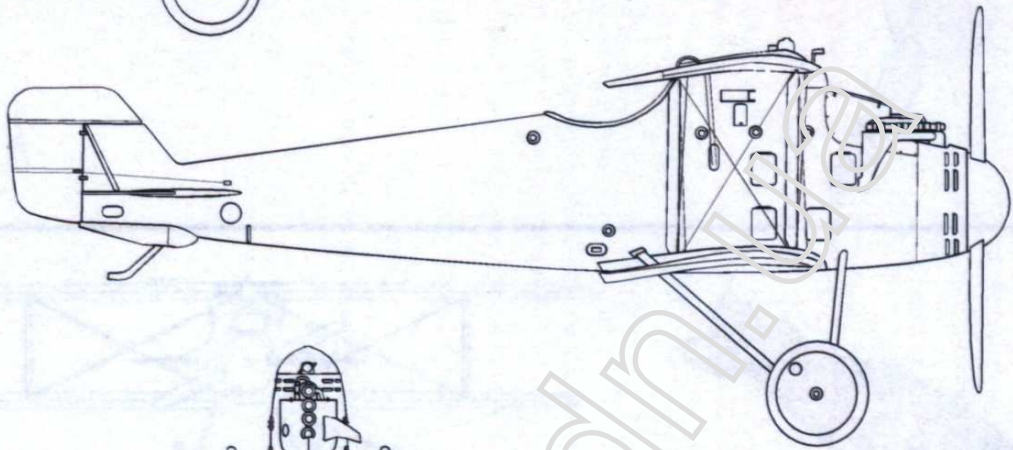
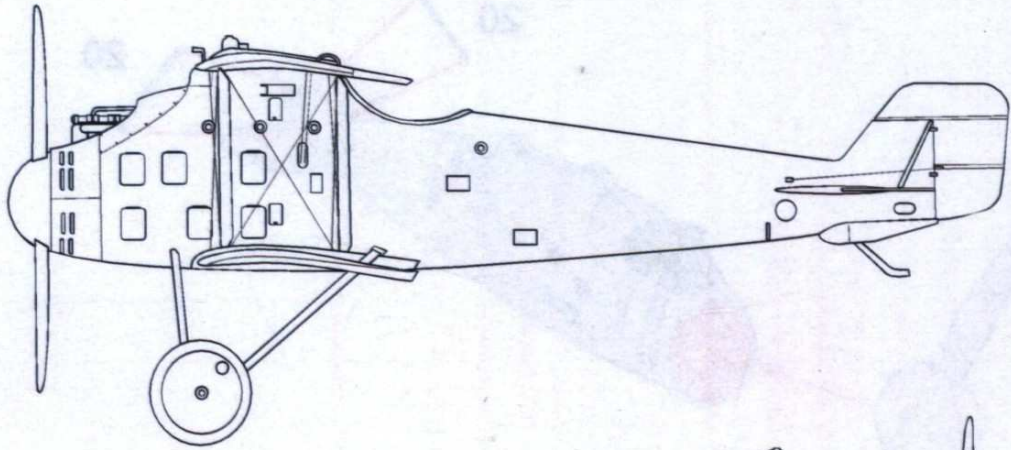

**1** Pfalz D II, 2876/16, pilot Hans Pippart, 1917.  
 Pfalz D II, 2876/16, flown by Hans Pippart, 1917.

**Zbarvení & Označení**  
**Colours & Markings**

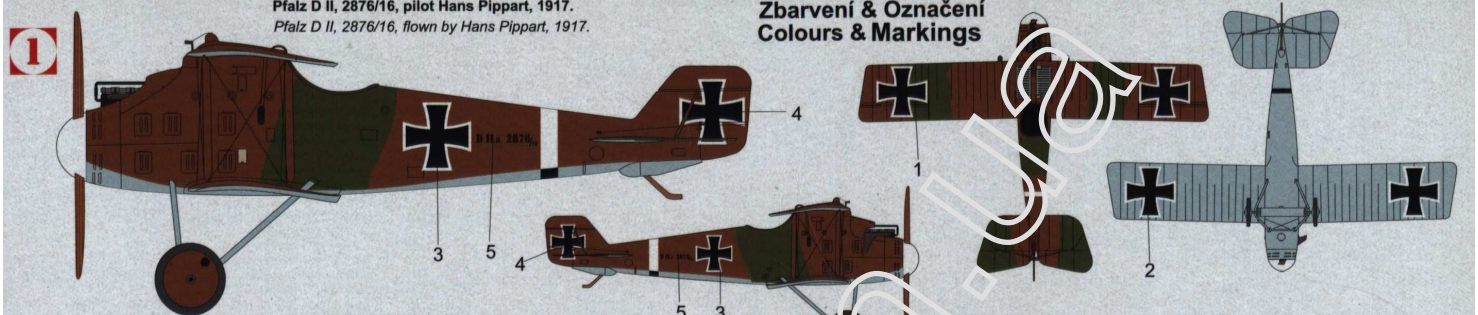

**2** Pfalz D II, východní fronta, 1917.  
 Pfalz D II, Eastern Front, 1917.

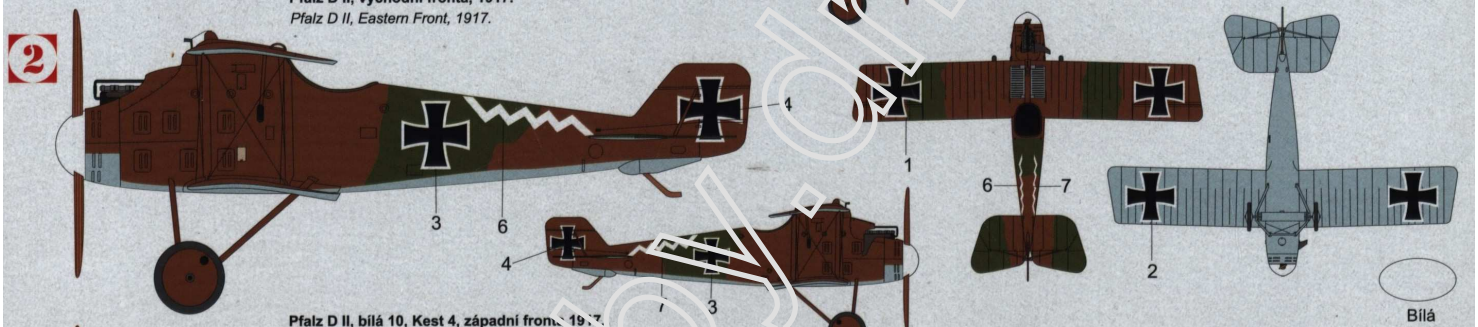

**3** Pfalz D II, bílá 10, Kest 4, západní fronta, 1917.  
 Pfalz D II, White 10, Kest 4, Western Front, 1917.

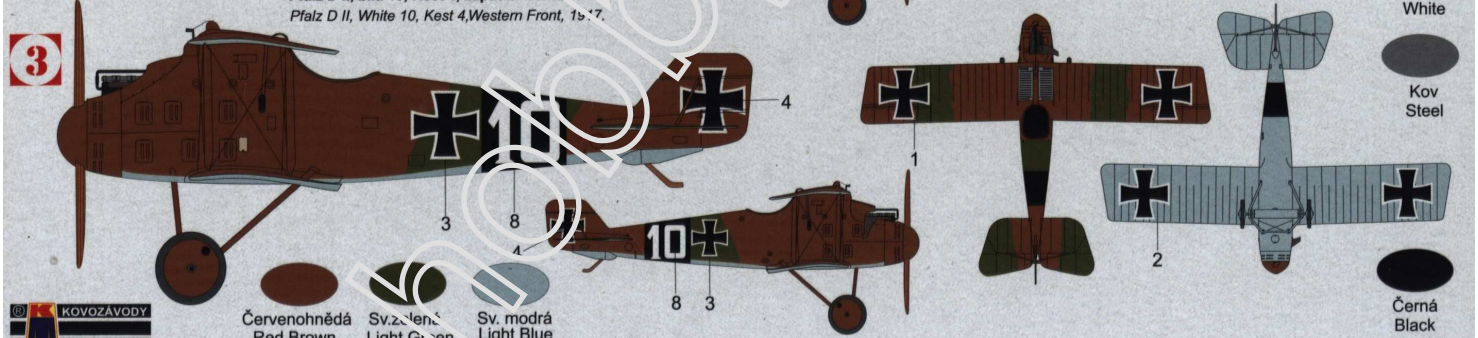

-  Bílá  
White
-  Kov  
Steel
-  Černá  
Black

-  Červenohnědá  
Red Brown
-  Sv. zelená  
Light Green
-  Sv. modrá  
Light Blue