

Suchoj Su-7UMK

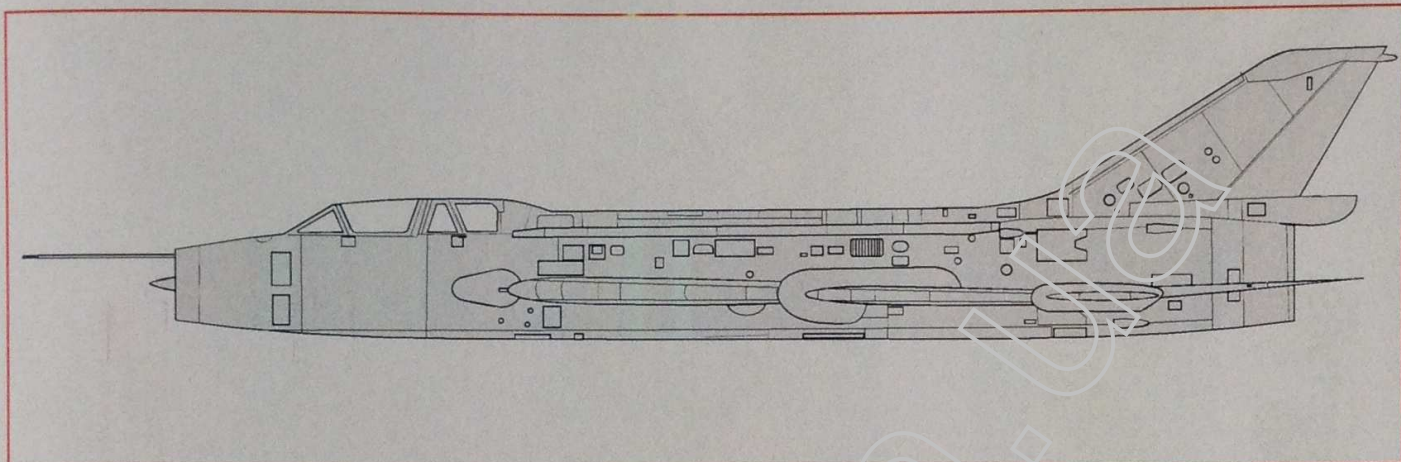

Historie / History

https://en.wikipedia.org/wiki/Sukhoi_Su-7

21

?

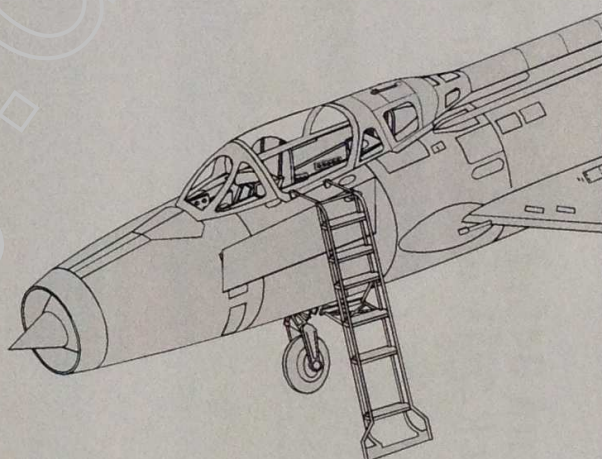
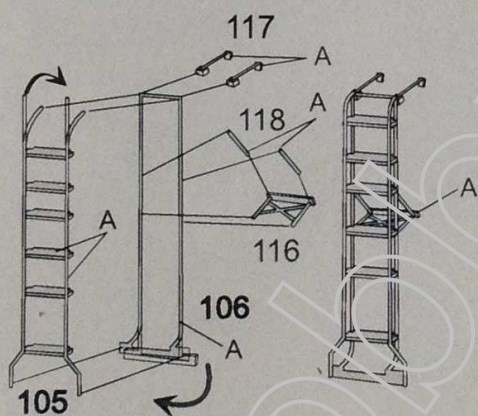



VOLITELNÉ
OPTIONAL

VYVRTAT
DRILL HOLE

ZBROUSIT
REDUCE

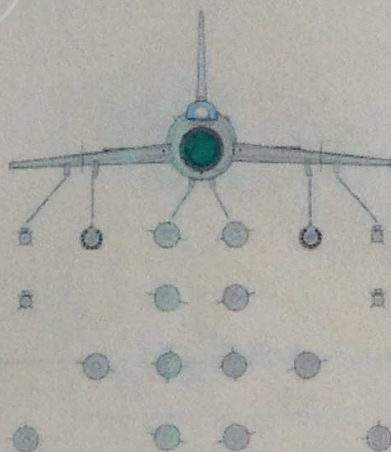
ODSTRANIT
REMOVE



Zavěsníky/External stores

Použité barvy/Paints used:

AGD Code	Barva/Colour	HUMBROL	AGAMA
A	Oranžová Orange	82	03
B	Červená Red	60	04
C	Černá Black	33	07
D	Stříbrná Silver	11	08
E	Stříbrná Glossmetal	53	32
F	Námořní Steel	56	46
G	Zelená Green	76	A52
H	Tmavá zelená Dark Green	105	A36
I	Světlá šedá Light Grey	64	A6
J	Hnědá Brown	29	B2
K	Šedá Grey	106	C-11
L	Kůže Leather	98	F6
M	Světlá hnědá Light Brown	110	24
N	Modrošedá Blue Grey	175	N3
O	Světlá modrá Light Blue	85	N5
P	Tmavá zelená Dark Green	114	R1

Plastikové díly - Plastic parts

Průhledné díly / Clear parts

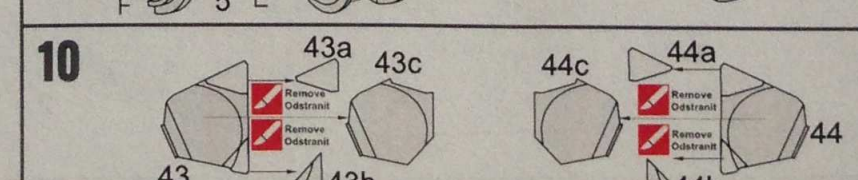
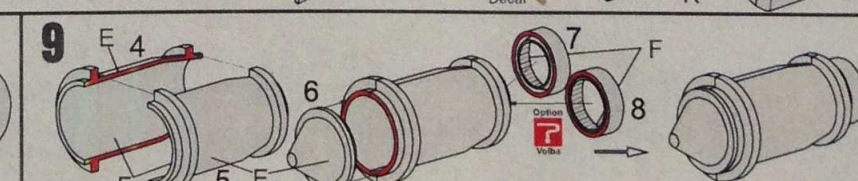
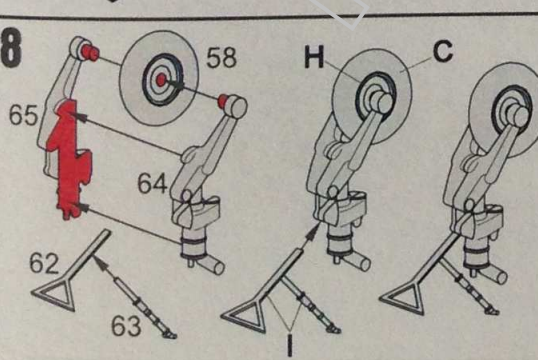
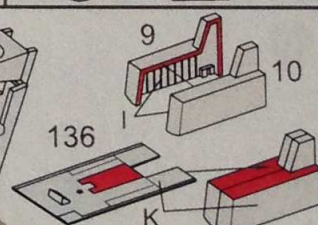
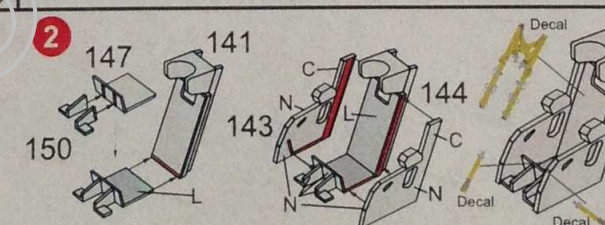
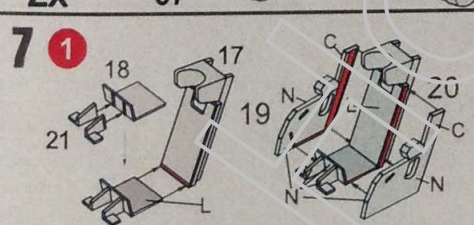
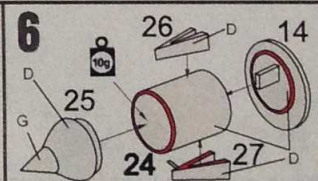
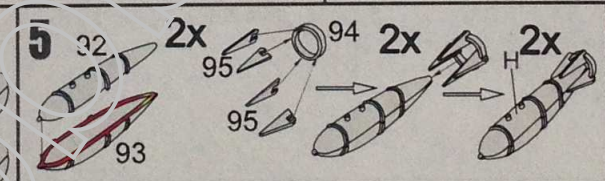
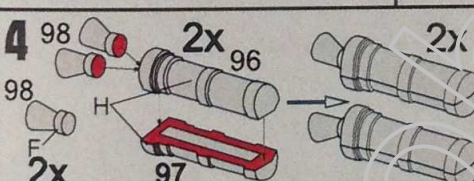
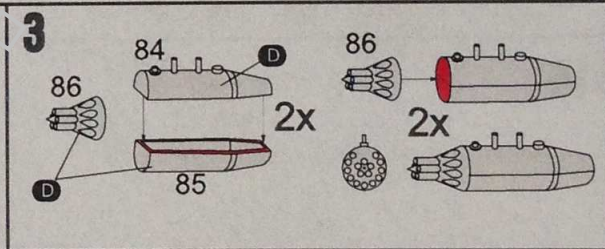
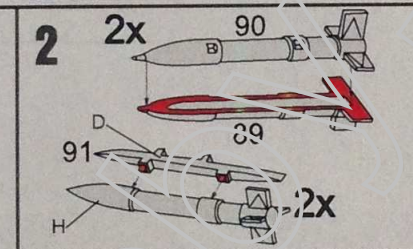
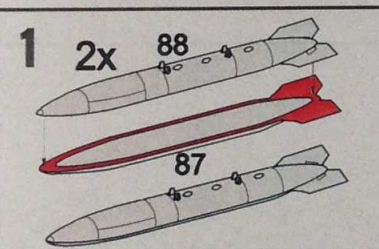
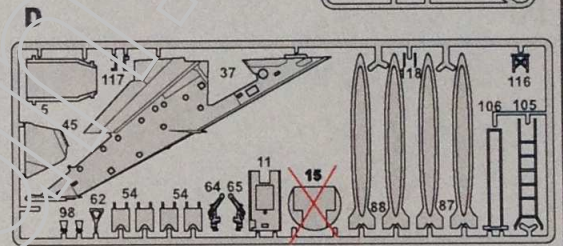
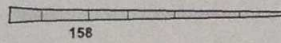
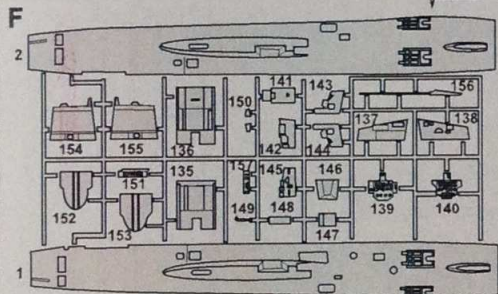
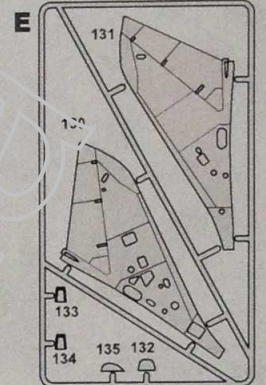
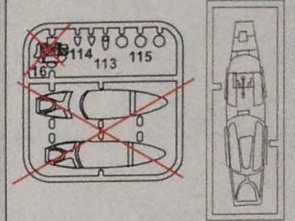
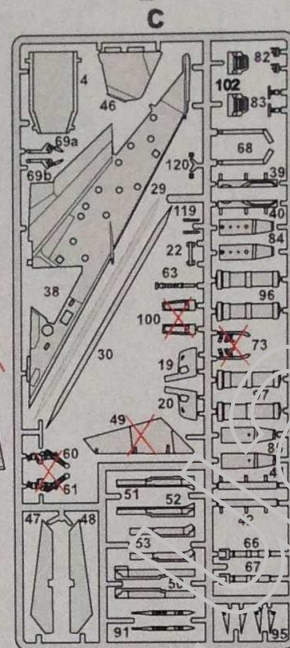
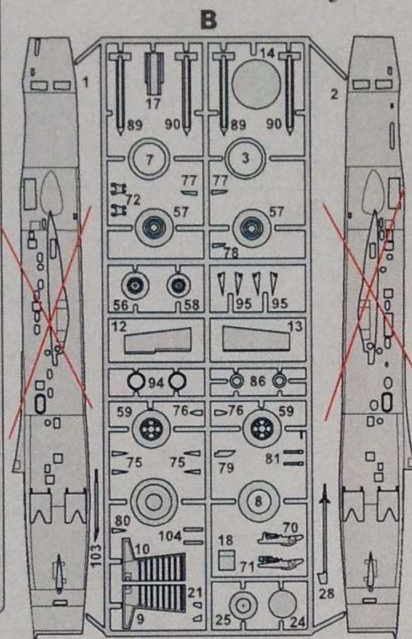
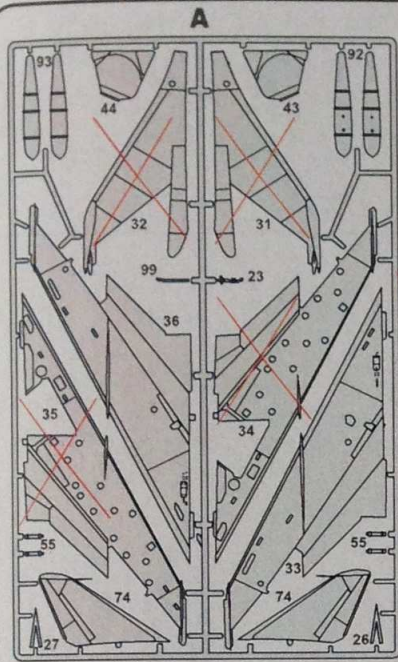

17

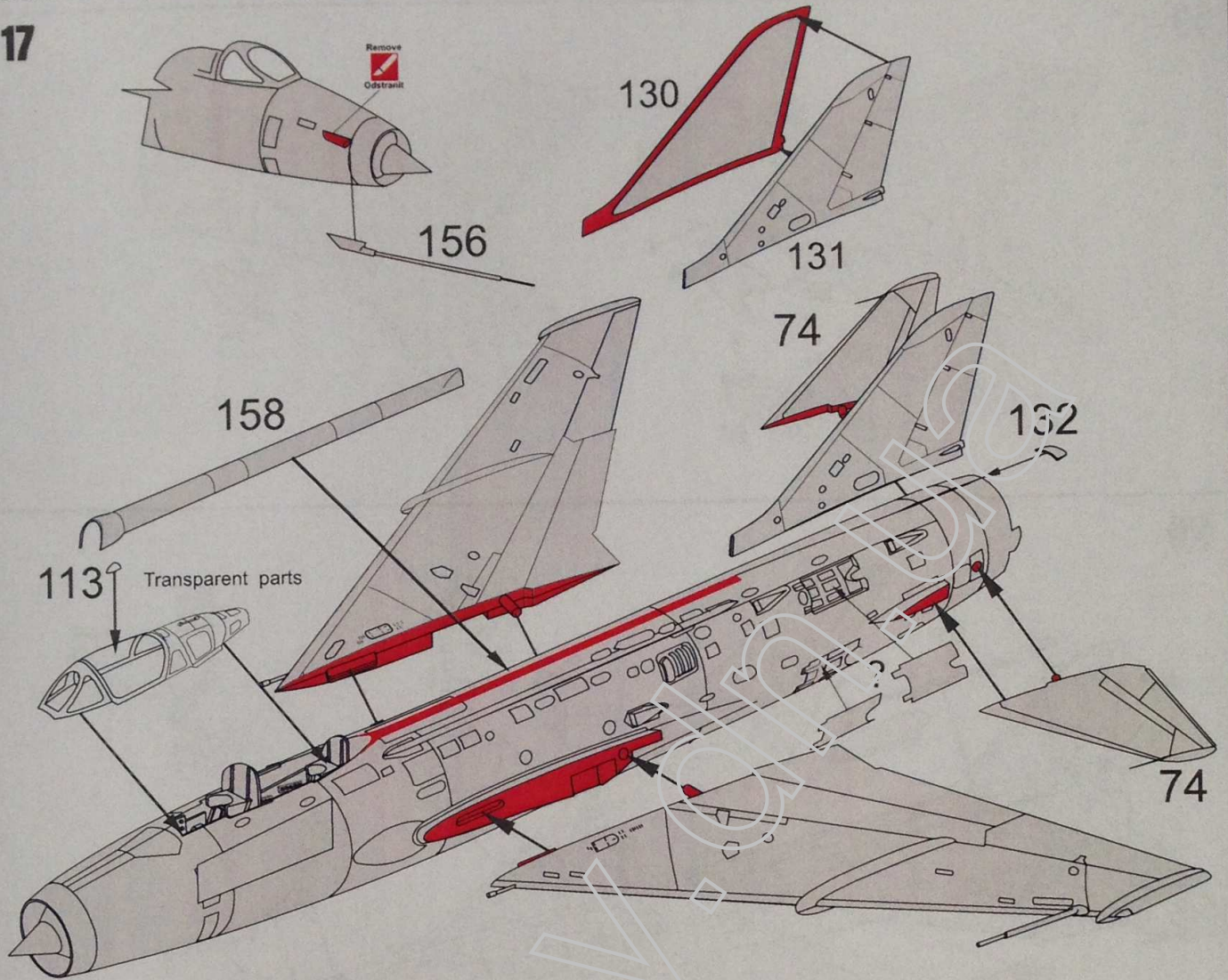

18

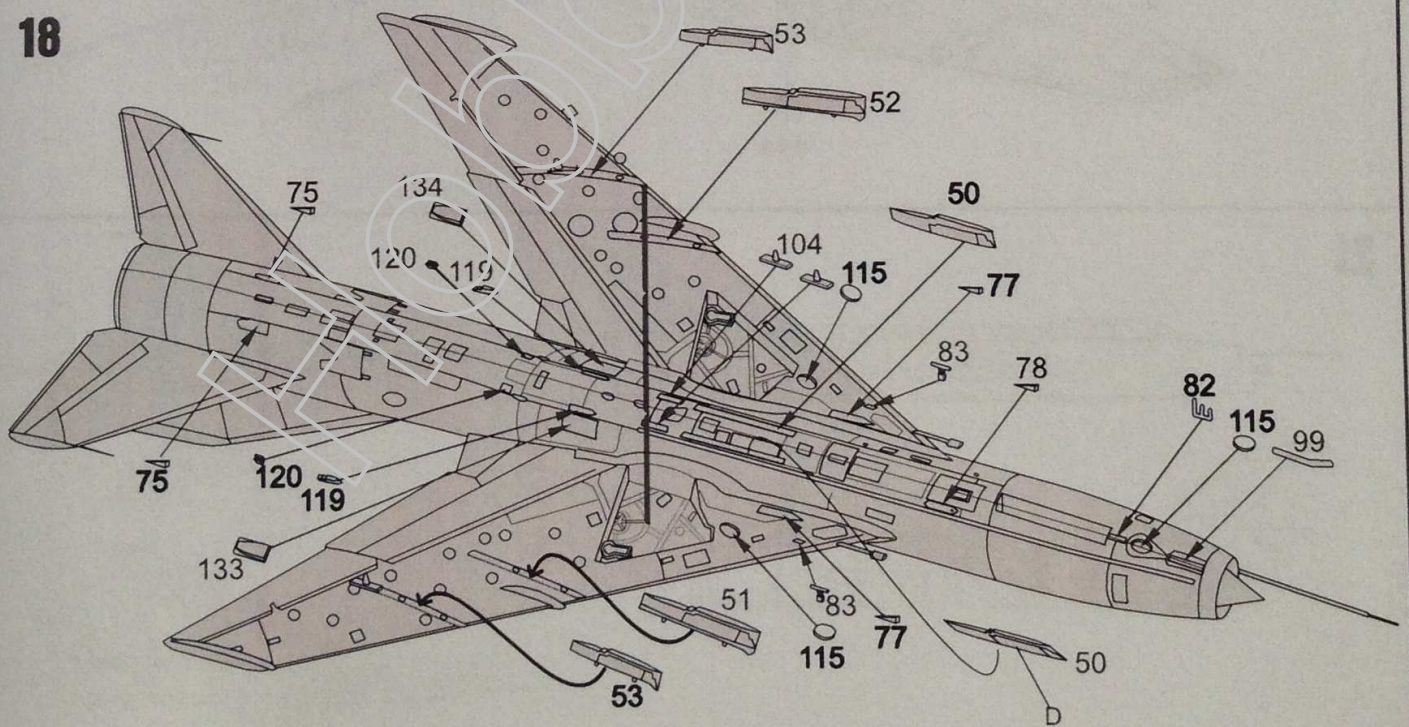

19

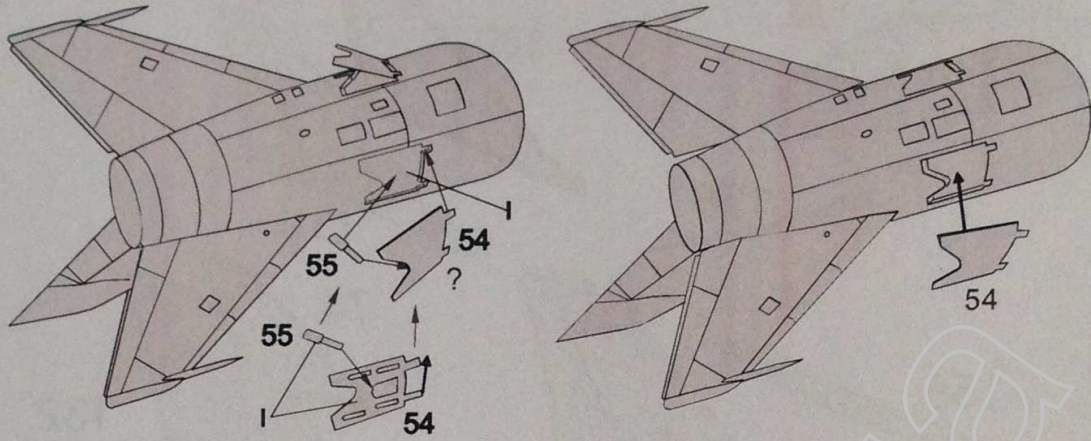

20

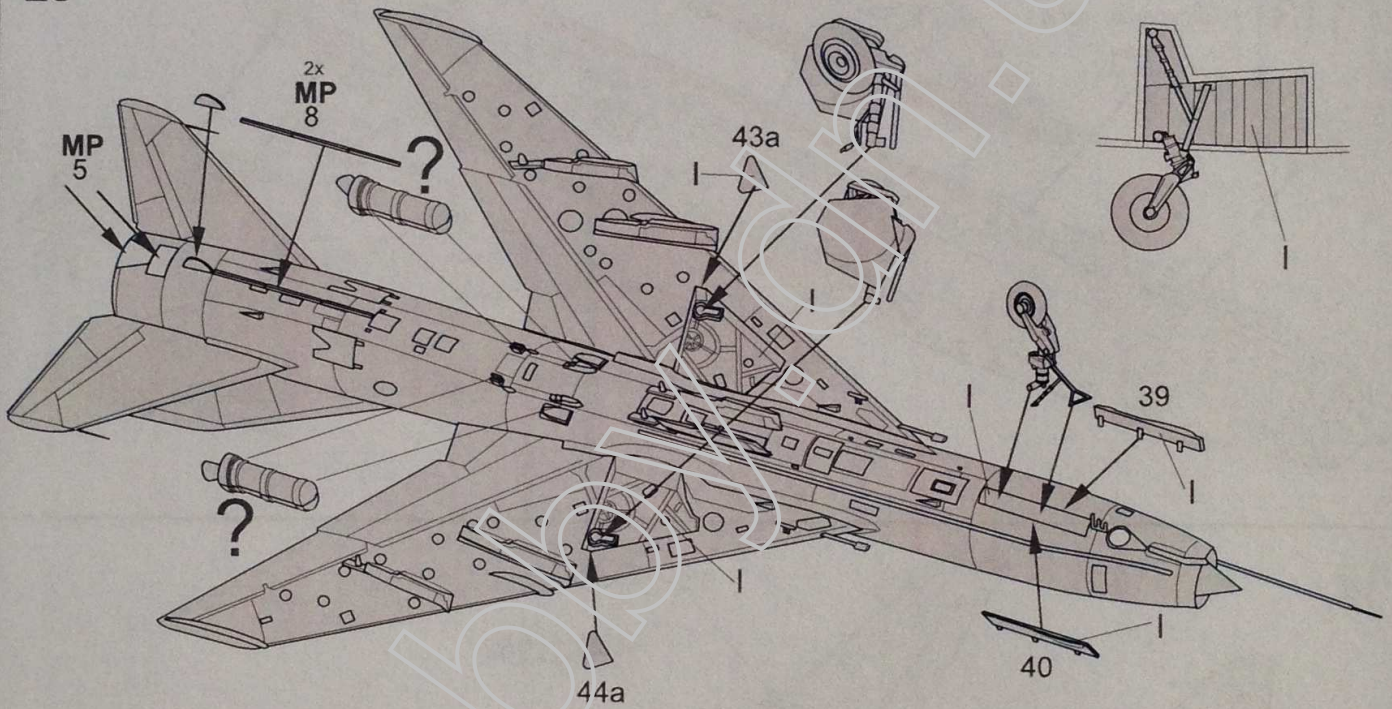

21

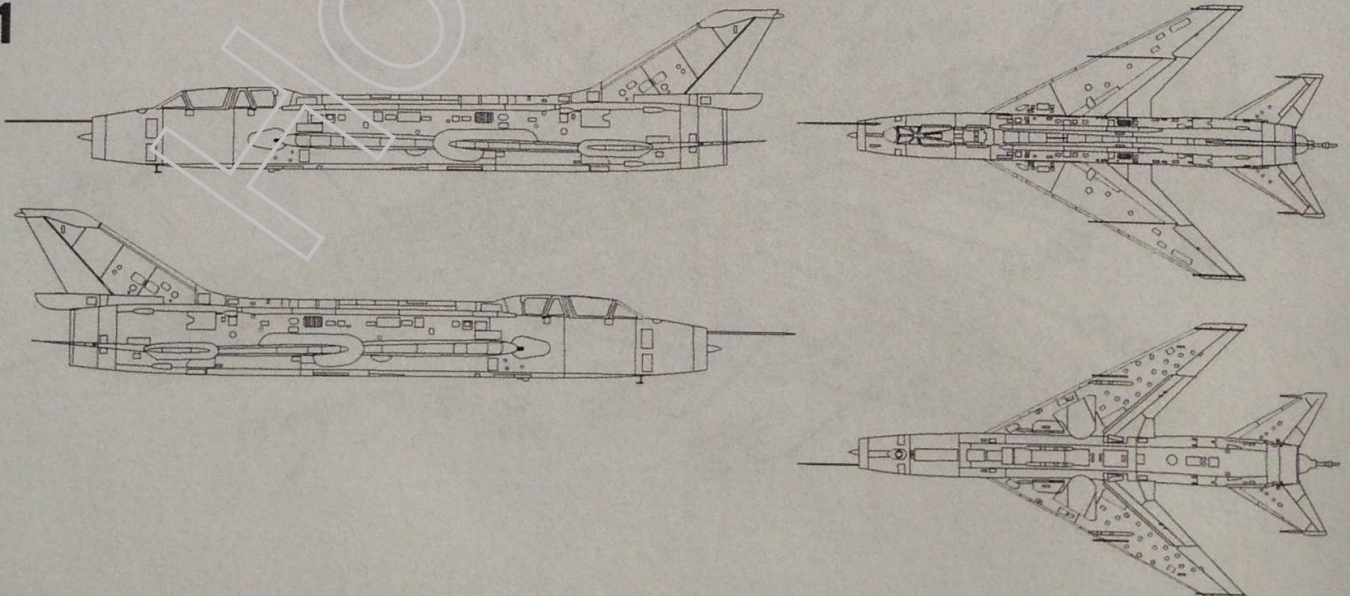

1

Su-7UMK, černá 340, Alžírské voj. letectvo 1989.
Su-7UMK, black 340, Algerian Air Force 1989.

Zbarvení & Označení
Colours & Markings

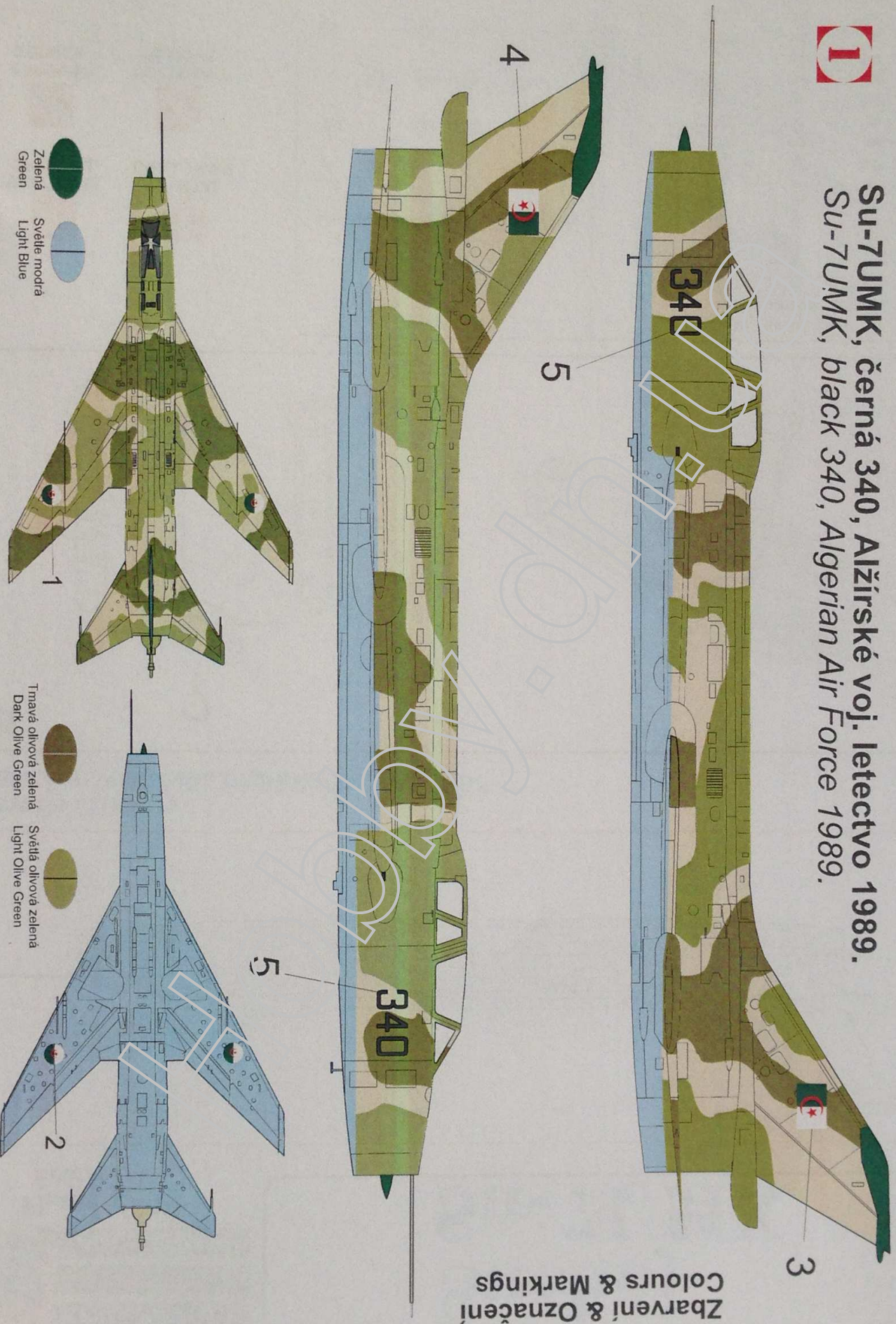

Zelená
Green

Světle modrá
Light Blue

Tmavá olivová zelená
Dark Olive Green

Světlá olivová zelená
Light Olive Green

Su-7UMK, Egyptské voj. letectvo 1989.
 Su-7UMK, Egyptian Air Force 1989.

Zbarvení & Označení
 Colours & Markings

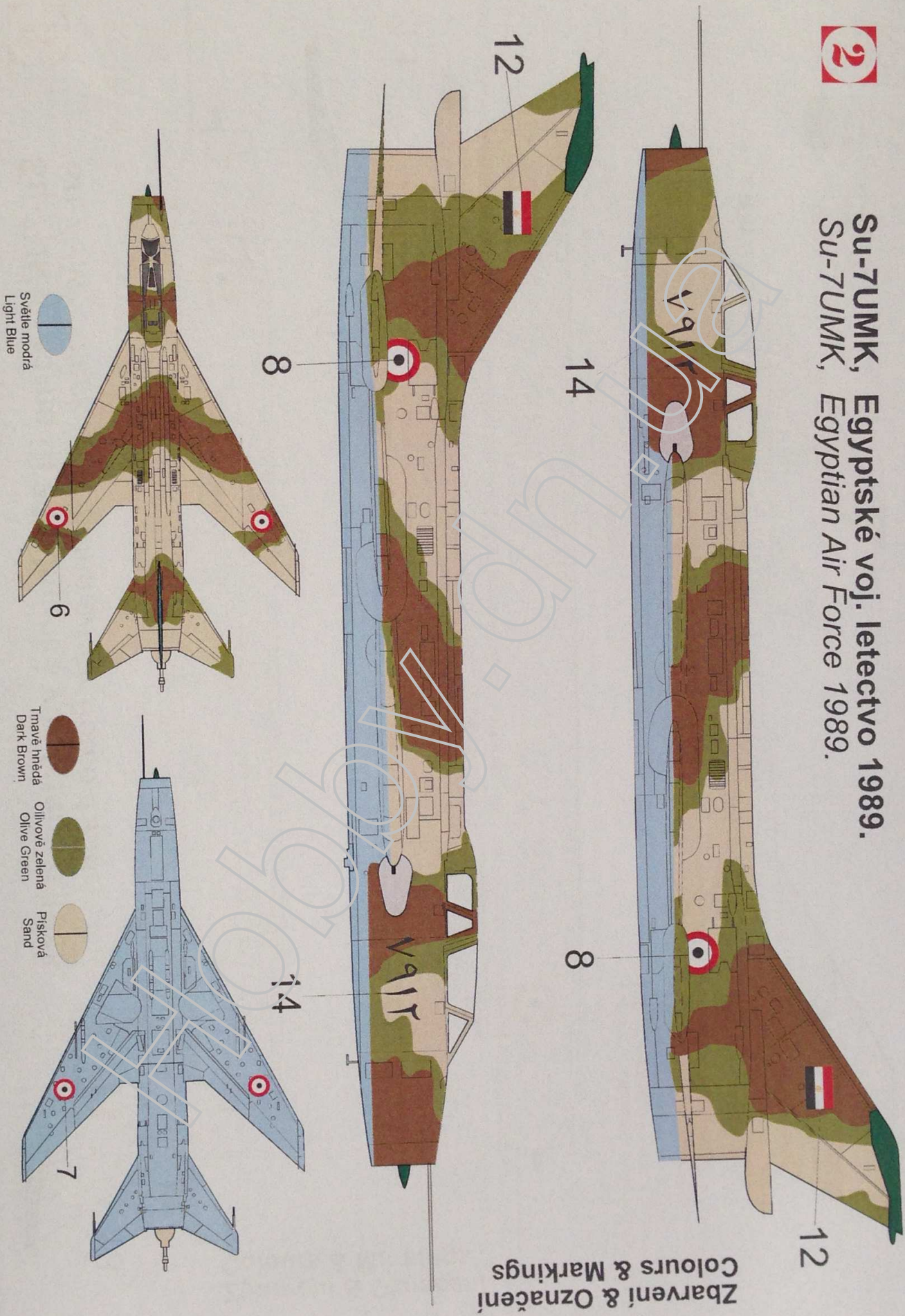

Světle modrá
 Light Blue

Tmavě hnědá
 Dark Brown

Olivově zelená
 Olive Green

Písková
 Sand

Su-7UMK, černá UI 358, Indické voj. letectvo 1988.
Su-7UMK, black UI 358, Indian Air Force 1988.

