

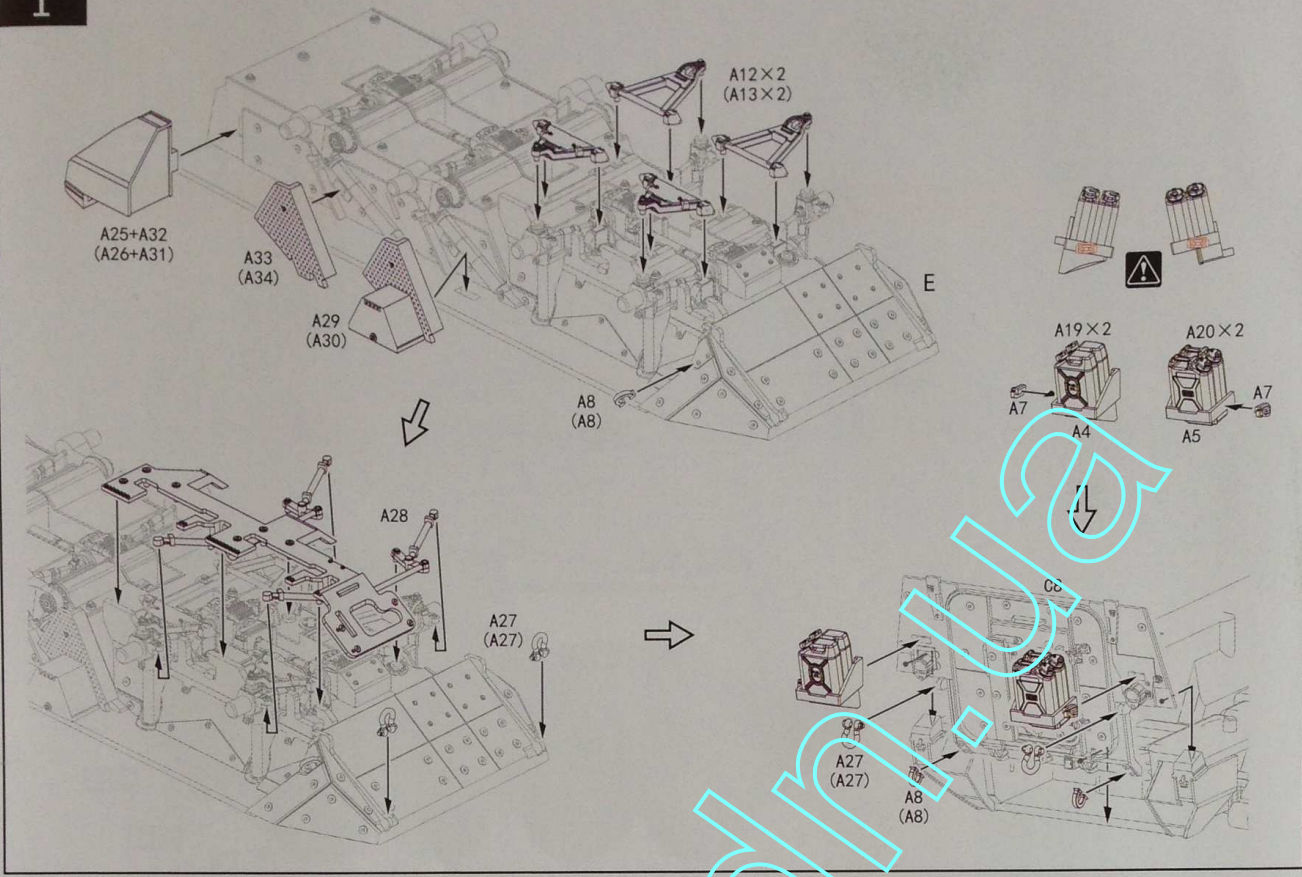



1



2

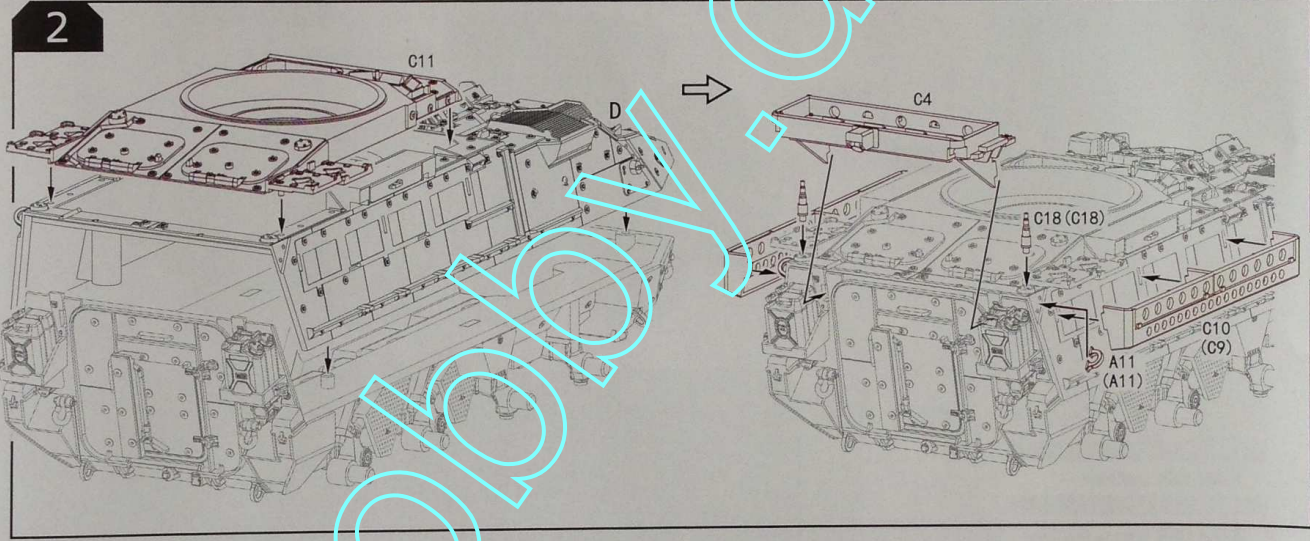

3

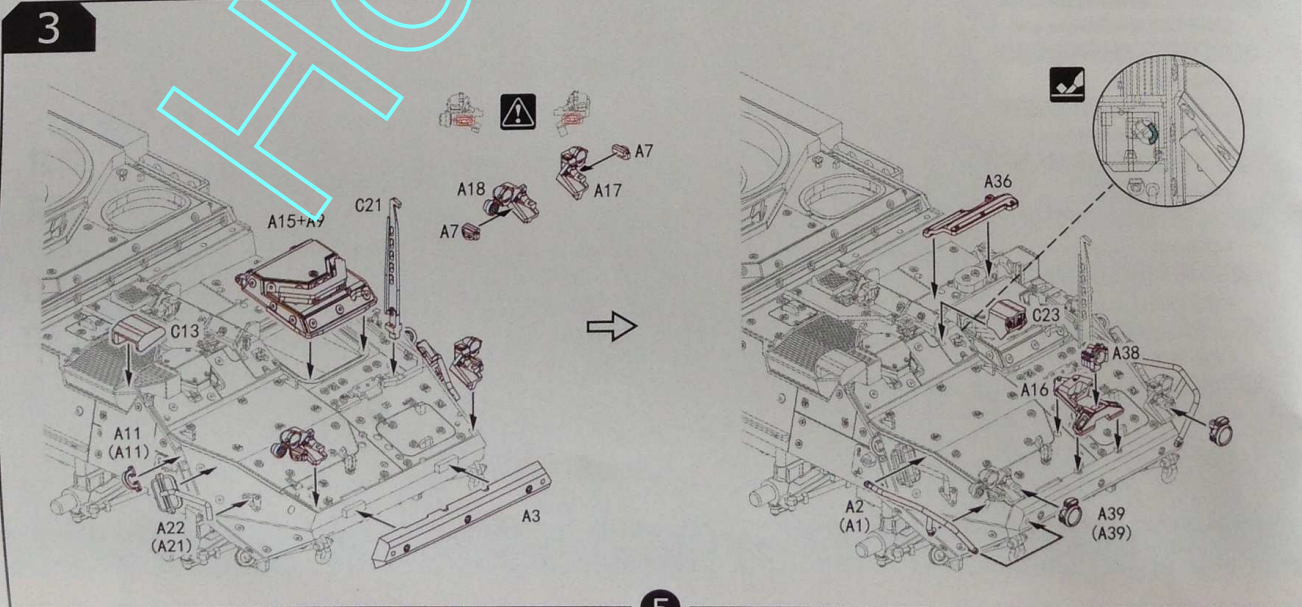

5







# STRYKER M1296 DRAGOON



S1

## PAINTING AND MARKING GUIDE

REF: TK7007

 A.MIG-0025 US Modern Vehicles FS 33446	 A.MIG-0033 Rubber & Tires	 A.MIG-0038 Light Wood	 A.MIG-0045 Gun Metal
 A.MIG-0049 Red	 A.MIG-0065 Forest Green FS 34102	 A.MIG-0093 Crystal Red	 A.MIG-0094 Crystal Glass
 A.MIG-0095 Crystal Smoke	 A.MIG-0097 Crystal Orange	 A.MIG-0099 Crystal Black Blue	 A.MIG-0191 Steel
 A.MIG-0195 Silver			

MVOALE  
MVOALE  
MVOALE

1/2CAV  
1/2CAV

1/2CAV  
1/2CAV

HHT-22  
HHT-22

HHT-22  
HHT-22

### 1 GENERAL WASH

A.MIG-1008 Dark Wash

### 2 FILTER

A.MIG-1508 Green for Grey Green

### 3 STREAKING

A.MIG-1253 Streaking brusher Grimy

### 4 WHEELS WASH

A.MIG-1403 Earth

### 5 RAINMARKS

A.MIG-1208 Rainmarks Effects

### 6 DUST

A.MIG-3030 Factory Dirt Ground Pigment

### 7 MUD

A.MIG-1703 Moist Ground

### 8 SPLASHES

A.MIG-1752 Loose Ground

### 9 FUEL

A.MIG-1409 Fuel Stains

### 10 OIL

A.MIG-1408 Fresh Engine Oil

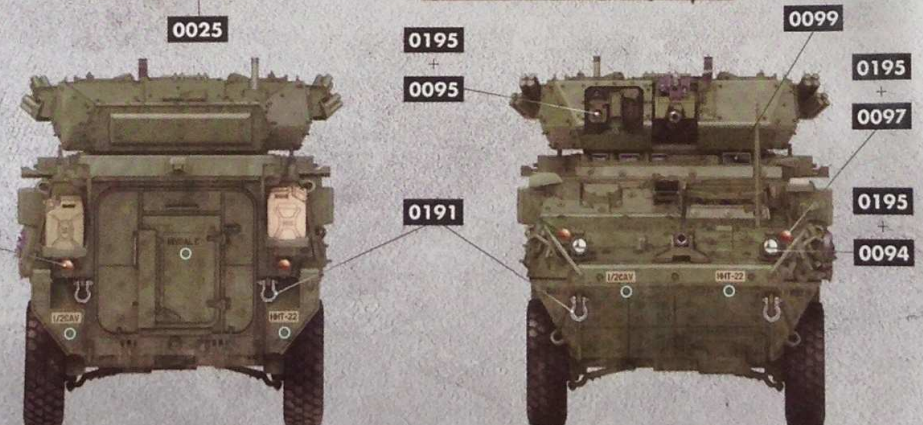
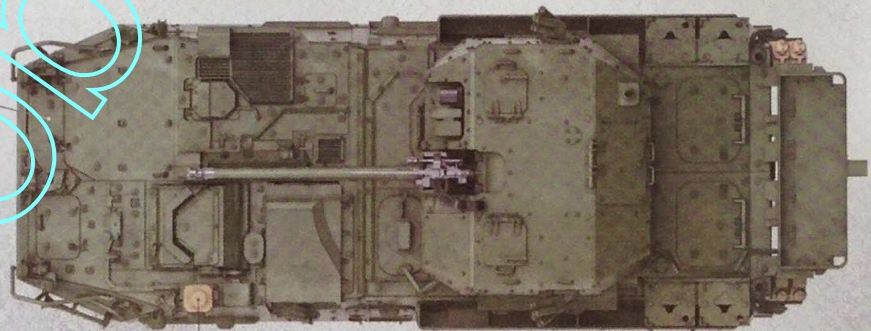
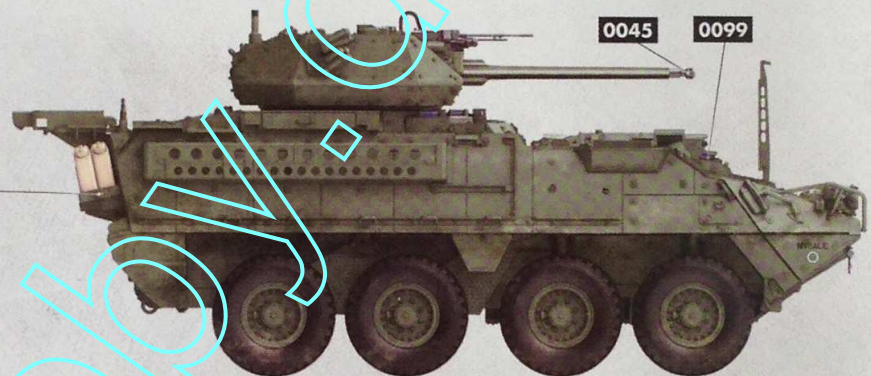
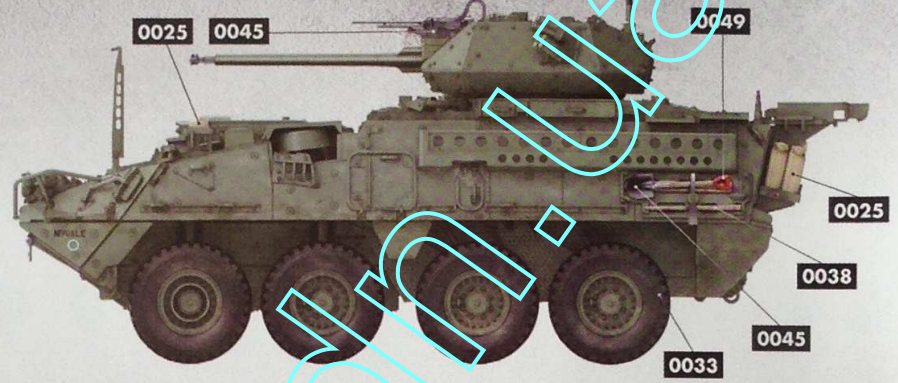

WEATHERING STEPS WITH AMMO PRODUCTS



# STRYKER M1296 DRAGOON



S2

## PAINTING AND MARKING GUIDE

REF: TK7007

A.MIG-0025 US Modern Vehicles FS 33446	A.MIG-0033 Rubber & Tires	A.MIG-0038 Light Wood	A.MIG-0045 Gun Metal
A.MIG-0049 Red	A.MIG-0065 Forest Green FS 34102	A.MIG-0093 Crystal Red	A.MIG-0094 Crystal Glass
A.MIG-0095 Crystal Smoke	A.MIG-0097 Crystal Orange	A.MIG-0099 Crystal Black Blue	A.MIG-0191 Steel
A.MIG-0195 Silver			

MVOALL

MVOALL

MVOALL

3/2GAV

3/2GAV

K-32

K-32

### 1 GENERAL WASH

A.MIG-1008 Dark Wash

### 2 FILTER

A.MIG-1508 Green for Grey Green

### 3 STREAKING

A.MIG-1253 Streaking/brusher Grime

### 4 WHEELS WASH

A.MIG-1403 Earth

### 5 RAINMARKS

A.MIG-1208 Rainmarks Effects

### 6 DUST

A.MIG-3030 Factory Dirt Ground Pigment

### 7 MUD

A.MIG-1703 Moist Ground

### 8 SPLASHES

A.MIG-1752 Loose Ground

### 9 FUEL

A.MIG-1409 Fuel Stains

### 10 OIL

A.MIG-1408 Fresh Engine Oil

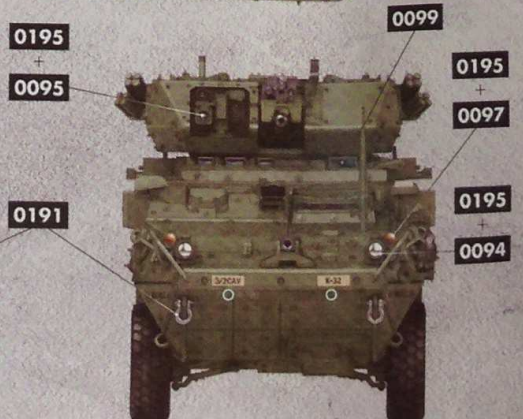
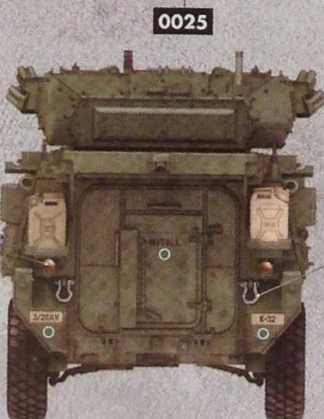
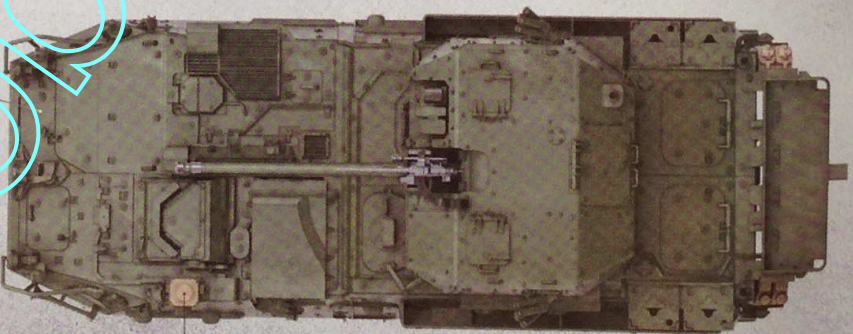
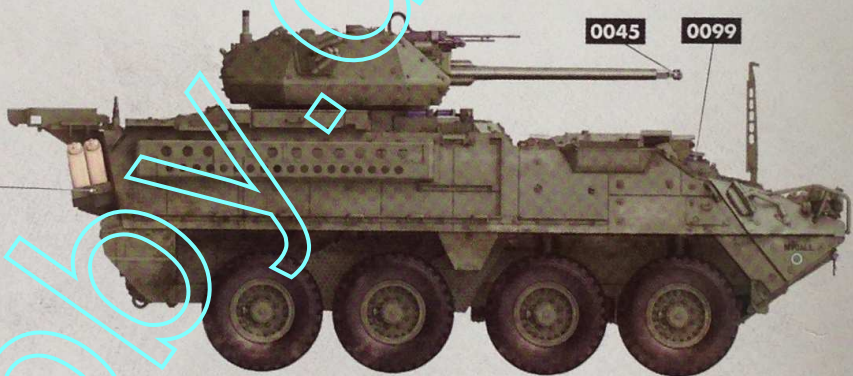
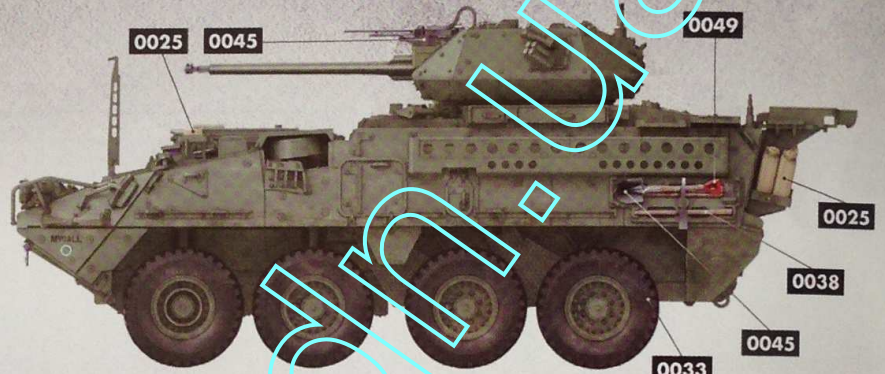



# STRYKER M1296 DRAGOON

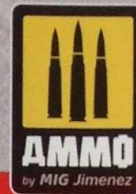

S3

S4

## PAINTING AND MARKING GUIDE

REF: TK7007

-  **A.MIG-0025** US Modern Vehicles FS 33446
-  **A.MIG-0033** Rubber & Tires
-  **A.MIG-0038** Light Wood
-  **A.MIG-0045** Gun Metal
-  **A.MIG-0049** Red
-  **A.MIG-0065** Forest Green FS 34102
-  **A.MIG-0093** Crystal Red
-  **A.MIG-0094** Crystal Glass
-  **A.MIG-0095** Crystal Smoke
-  **A.MIG-0097** Crystal Orange
-  **A.MIG-0099** Crystal Black Blue
-  **A.MIG-0191** Steel
-  **A.MIG-0195** Silver

MVOAK4	MVOAK7
MVOAK4	MVOAK7
MVOAK4	MVOAK7
P-14	P-13
P-14	P-13
4/2 CAV	4/2 CAV

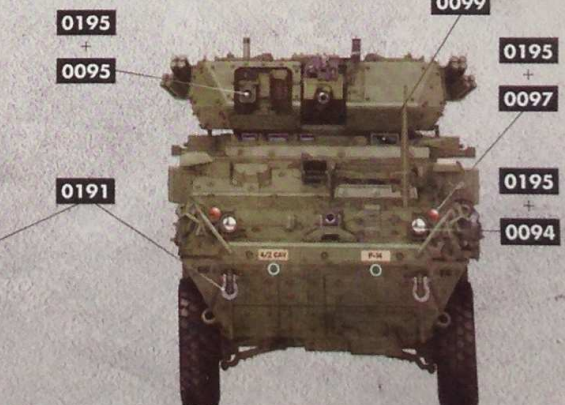
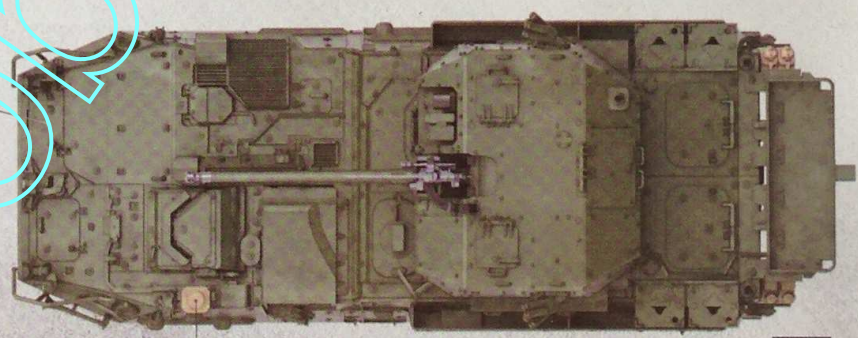
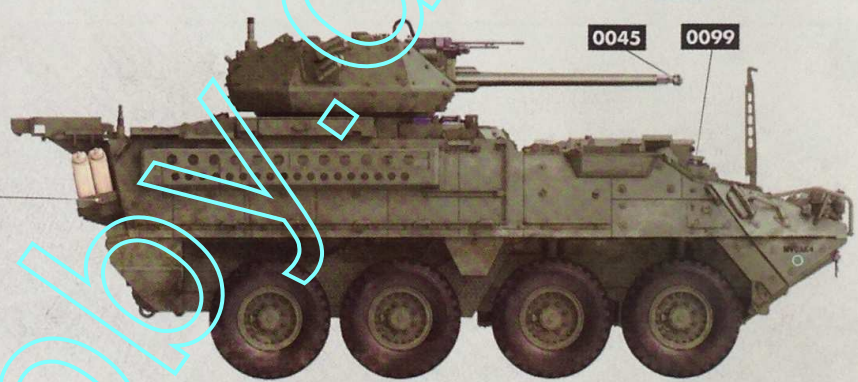
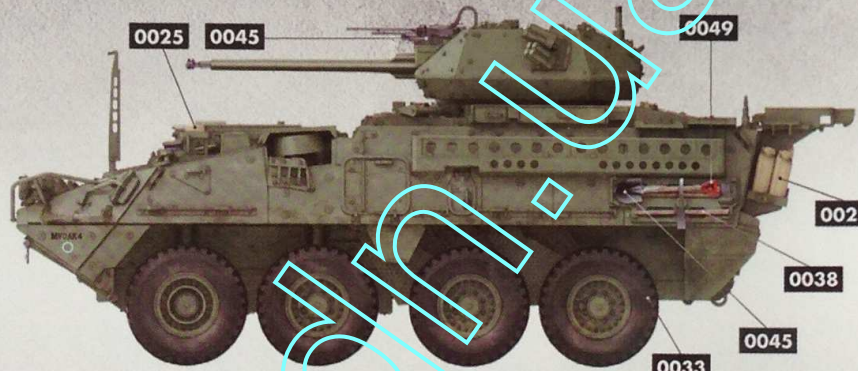

- 1 GENERAL WASH**  
A.MIG-1008 Dark Wash
- 2 FILTER**  
A.MIG-1508 Green for Grey Green
- 3 STREAKING**  
A.MIG-1253 Streaking brusher Grime
- 4 WHEELS WASH**  
A.MIG-1403 Earth
- 5 RAINMARKS**  
A.MIG-1208 Rainmarks Effects
- 6 DUST**  
A.MIG-3030 Factory Dirt Ground Pigment
- 7 MUD**  
A.MIG-1703 Moist Ground
- 8 SPLASHES**  
A.MIG-1752 Loose Ground
- 9 FUEL**  
A.MIG-1409 Fuel Stains
- 10 OIL**  
A.MIG-1408 Fresh Engine Oil

WEATHERING STEPS WITH AMMO PRODUCTS