

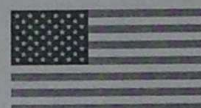

SOVA-M
SVM-14022

GA-43 Clark



UNASSEMBLED PLASTIC MODEL KITS

SCALE: 1/144

90 mm



112 mm

35 parts

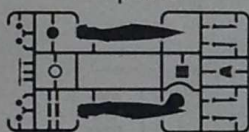

DECALS

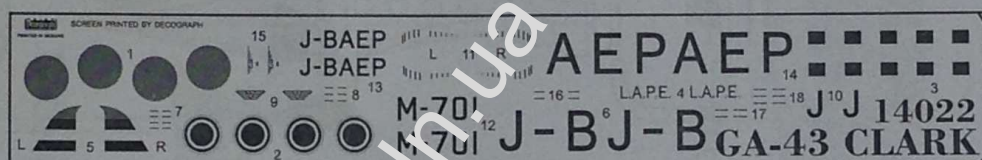

THREE VERSIONS
OF COLOURING

In 1930, General Aviation designed a 10 seat passenger aircraft, designated as General Aviation G.A.43. The maiden flight of the prototype aircraft (NX775N) took place on 22nd of May, 1932. For the early 1930s, the aircraft had very advanced onboard equipment, which included a full set of flight instruments for "Non-visual" flight, radio and transmitting equipment, as well as a short-wave receiver for promptly receiving weather forecasts and radio beacon signals. Sadly, the plane did not reach commercial success – only five machines of that type were built.

The model is executed on technology short run and is intended only for experienced modelers.

Word-wide distributor for Sova-M kits:
ModelSvit Balkans Ltd. 4003 Plovdiv,
Bulgaria 9, zk Maritza Gardens.
Tel. +359 32 397 069,
E-Mail: modelsvitbalkans@gmail.com
MADE IN UKRAINE

PAINTS

- | | |
|--|-------------------------------------|
| A HUMBROL 27002
POL. ALUMINIUM | B HUMBROL 33
BLACK |
| C HUMBROL 145
MEDIUM GREY | D HUMBROL 27004
GUN METAL |
| E HUMBROL 113
RUST | F HUMBROL 56
ALUMINIUM |
| G HUMBROL 19
RED | H HUMBROL 24
YELLOW |
| J HUMBROL 68
PURPLE | |

SYMBOLS

- | | | |
|----------------------------------|----------------------|---------------|
| 1 STAGES OF ASSEMBLY | TO PAINT | TO BEND |
| 1 NUMBER PARTS | GLUE | SCRATCH BUILT |
| APPLY DECALS | DON'T GLUE | OPEN HOLE |
| x2 QUANTITY OF OPERATIONS | НА ВИБІР
OPTIONAL | CUT OUT |

SET OF THE PARTS

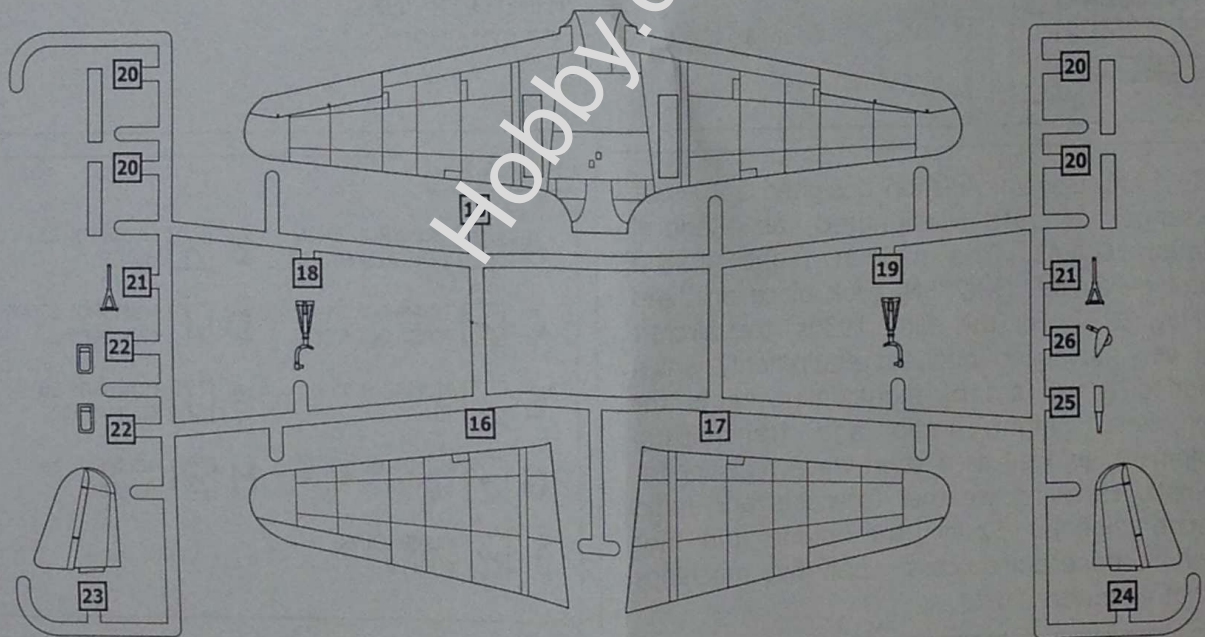
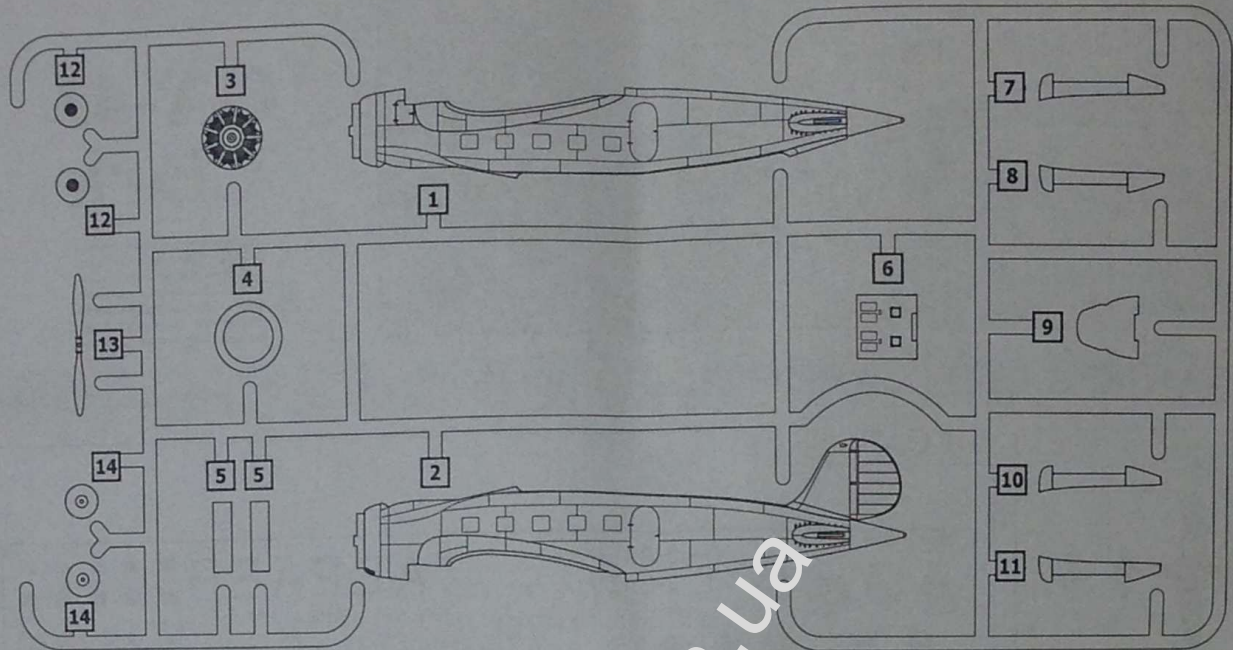

MARKING & PAINTING

GA-43 Clark



15

3

13

J

10

8

6

E

9

B

F

A

17

11L

1

B

7

8

8

7

E

AEP

14

AEP

14

A

J-B

6

8

8

10

11R

13

3

15

9

1

A

J-BAEP

17

1

J-B

6

8

10

1

en-tp-yqqoH Hobby

MARKING & PAINTING

GA-43 Clark

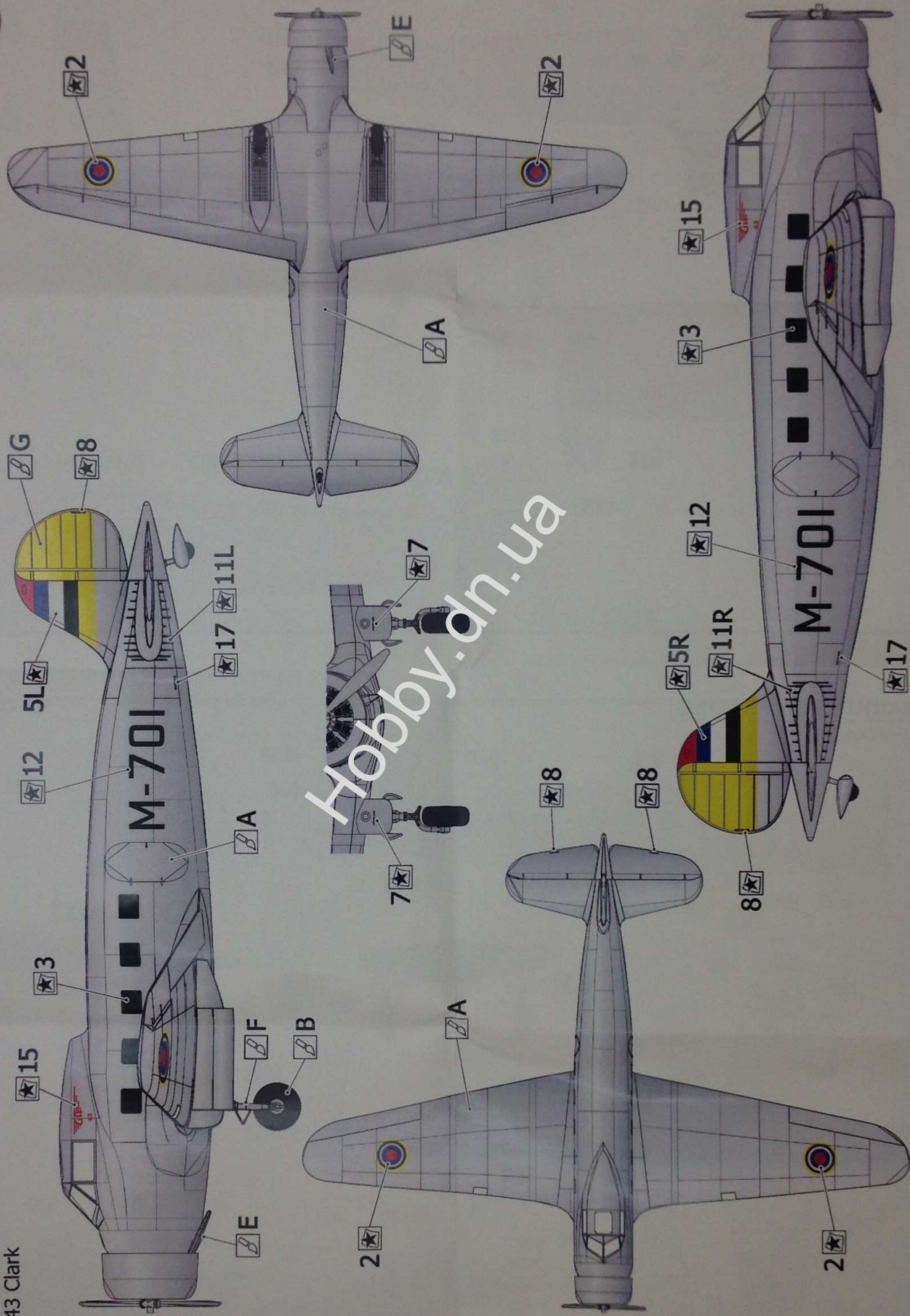

MARKING & PAINTING

GA-43 Clark



Hobby.dn.ua

ASSEMBLY INSTRUCTION



- 1**
- 6**
- 9**
- 22** x2

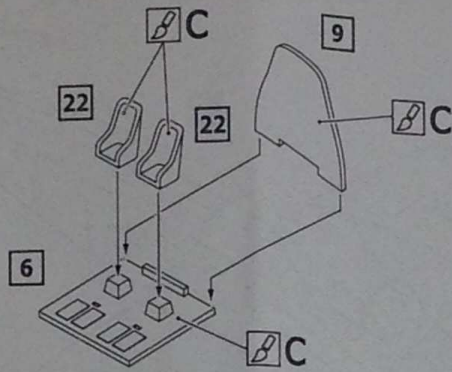

- 2**
- 1**
- 1**
- 2**
- 27**

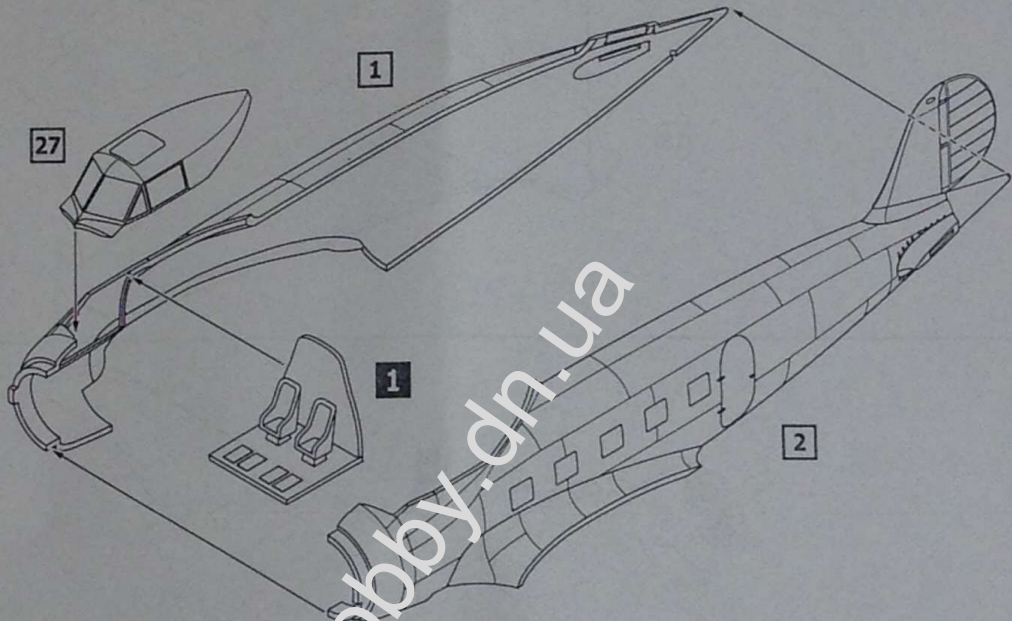

- 3**
- 2**
- 3**
- 4**
- 5** x2
- 13**

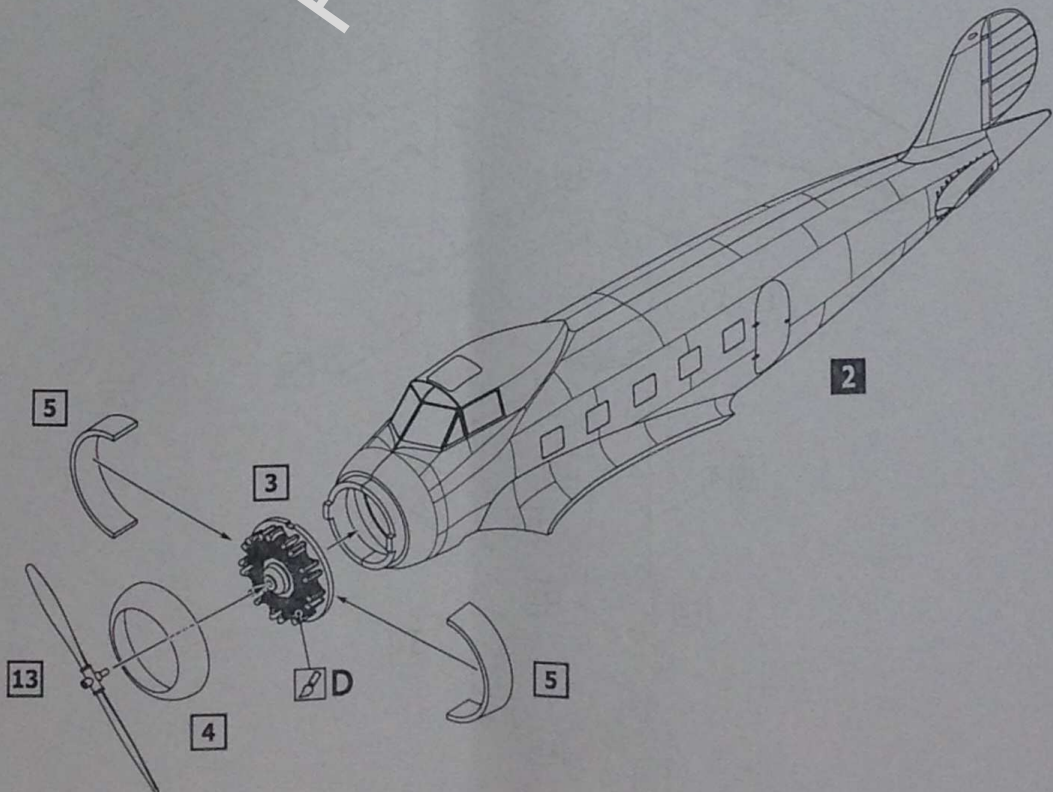

ASSEMBLY INSTRUCTION



- 4
- 3
- 15
- 16
- 17
- 23
- 24

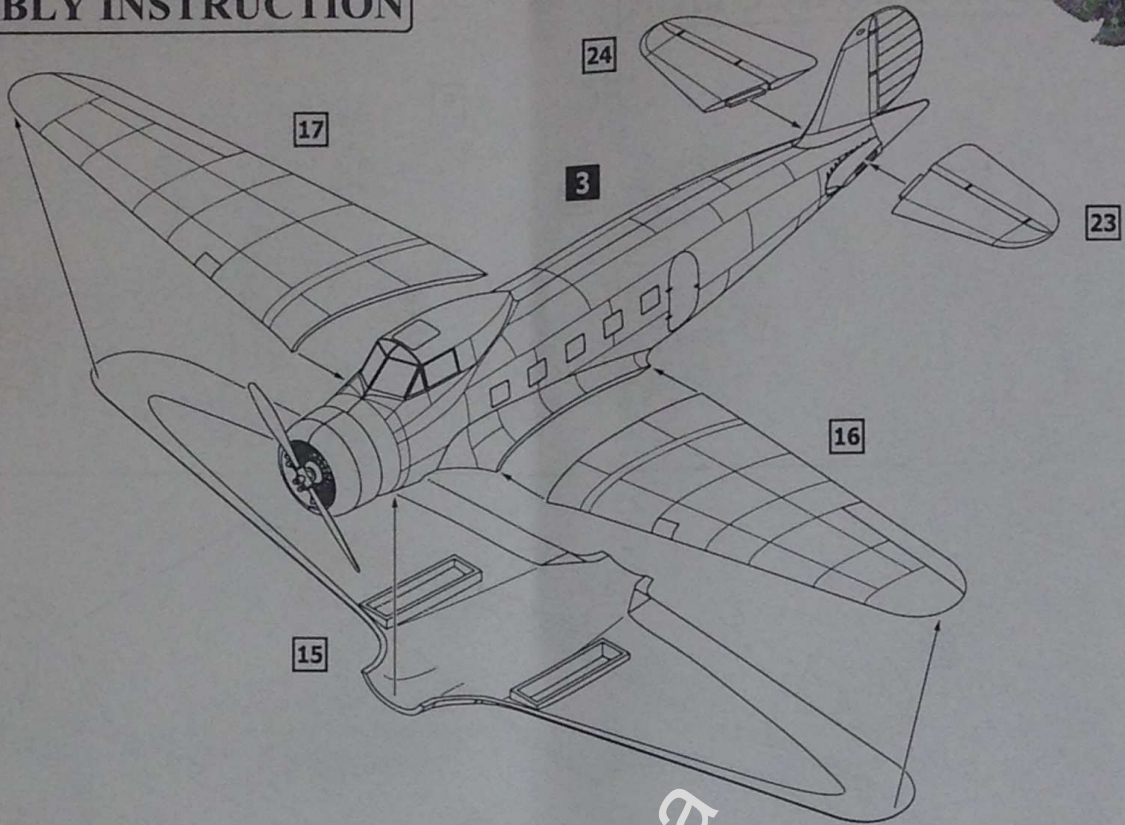

- 5
- 4
- 7
- 8
- 10
- 11
- 12 x2
- 14 x2
- 18
- 19
- 20 x4
- 21 x2
- 25
- 26

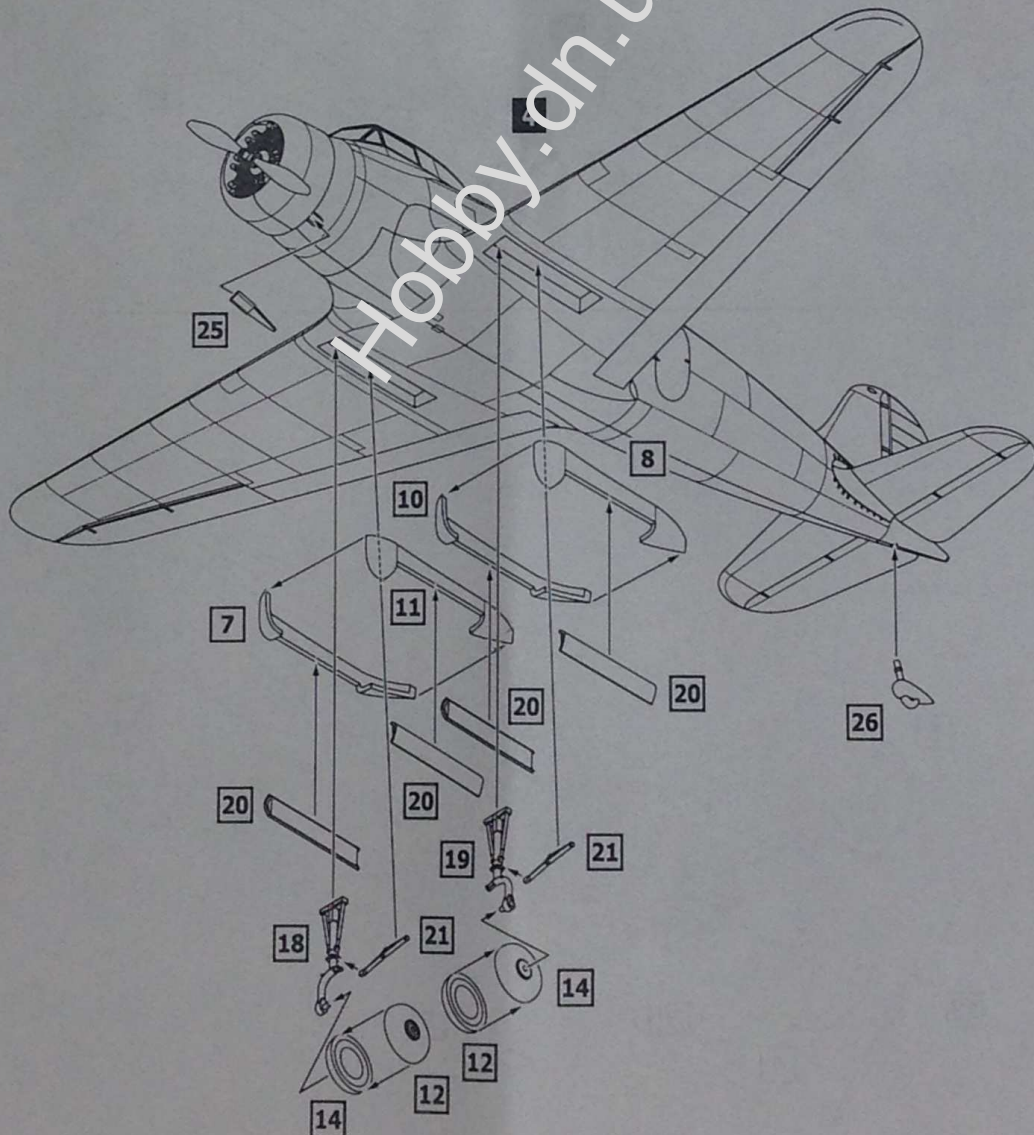

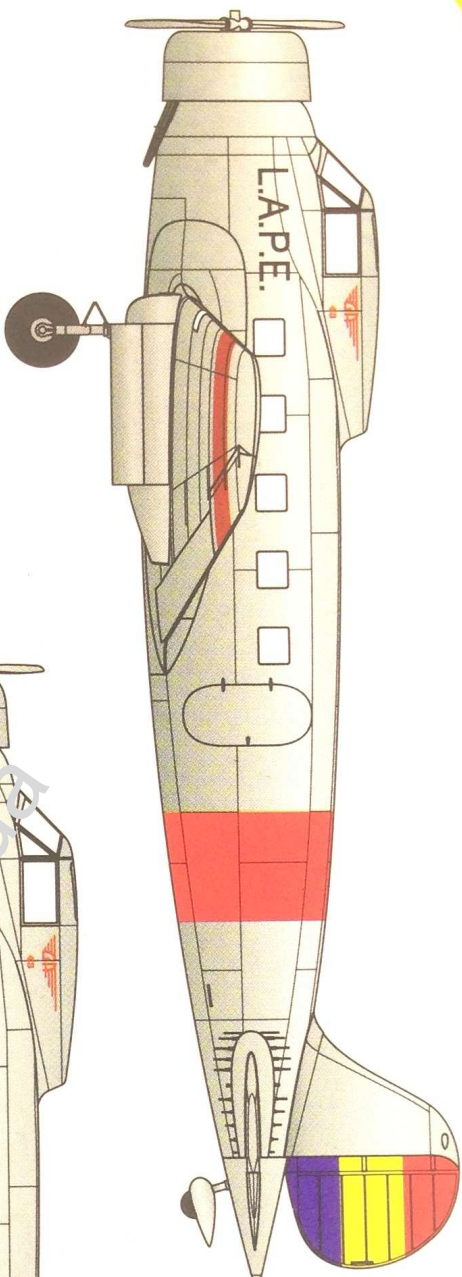

Ga-43 Clark Spain 1936

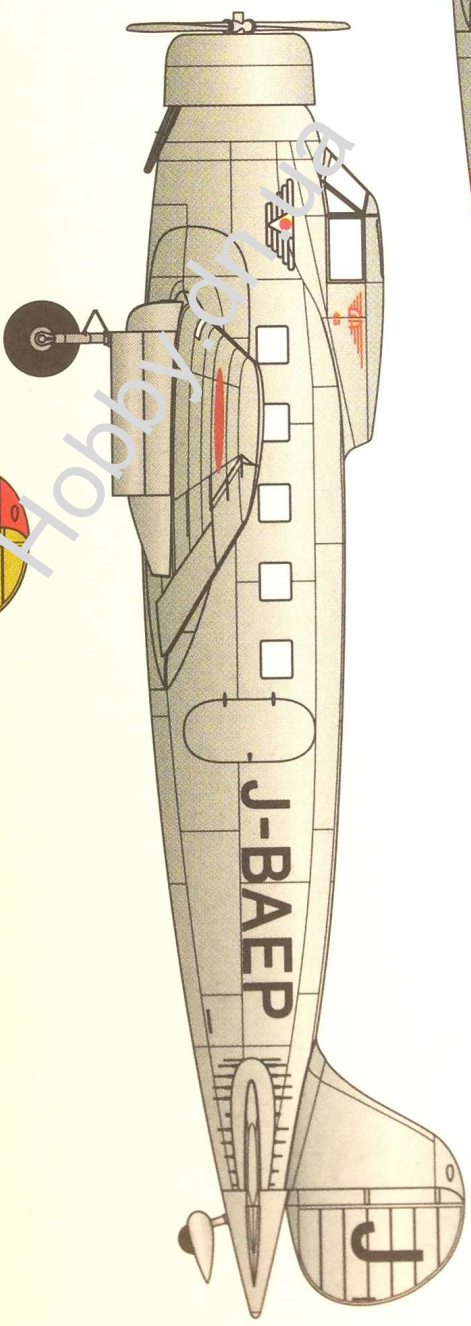

Ga-43 Clark Japan 1933

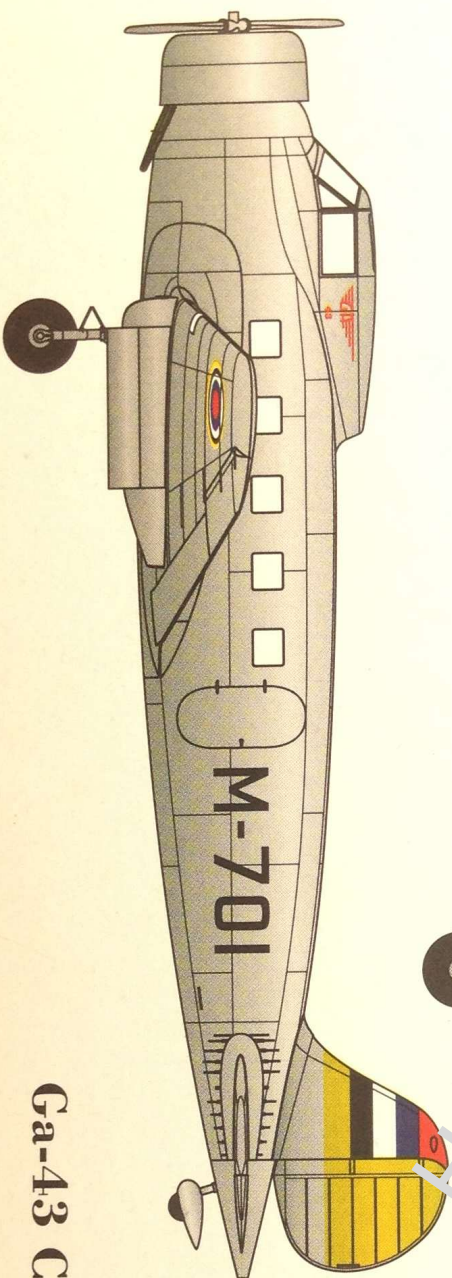

Ga-43 Clark Manzhouli 1934

LIMITED
EDITION