

# JAGDTIGER 128MM PaK L66 88MM PaK L71 2IN1

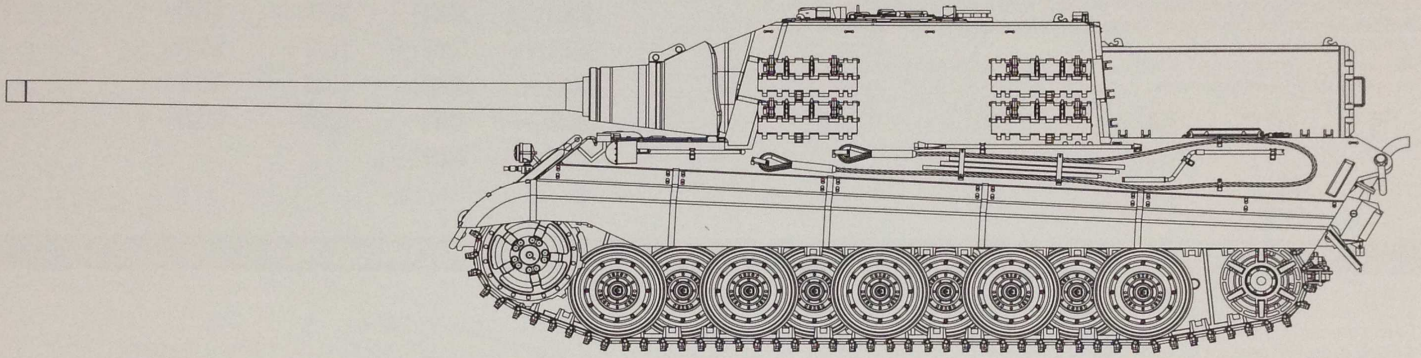

Based on the highly successful King Tiger, the 72-ton German Sd.Kfz. 186 Panzerjäger Tiger Ausf.B, or Jagdtiger, was the ultimate operational German tank hunter of WWII.

Two Prototypes were produced, one by Henschel and one by Porsche, mainly differing by their road wheel suspension systems, with the Henschel suspension system being eventually chosen for series production. An order for 150 vehicles was initially placed, with production commencing at Nibelungenwerk in St. Valentine (Steyr-Daimler-Puch) in July 1944. Production was slow due to the cumbersome weight of the various elements of the vehicle, as well as the factory being targeted by Allied strategic bombing missions. Only around 80 examples were ultimately produced before the end of the war.

The Jagdtiger was armed with the most powerful anti-tank gun in the German arsenal during World War II, the Krupp 12.8 cm PaK 44 L/55, capable of out-ranging and defeating any allied tank it could have faced. Due to initial concerns about difficulties supplying the 12.8 cm guns, a proposal was made to install the Krupp 8.8 cm KwK 43 L/71, but no evidence has ever been shown that this was ever done. Plans were also drawn-up to fit the much longer PaK 44 L/66 with an extension added behind the casemate, but the war ended before this could be implemented. Additional armament consisted of a single Rheinmetall 7.92mm MG 34 provided with a ball mount in the front-left side of the hull, and provisions for mounting another of these weapons externally on the engine deck for aerial defense. The main gun mount offered a very limited traverse of 10°, so if targets were outside its field of fire, the entire tank had to be turned and re-aimed, causing considerable stress on the engine and often jarring the gun out of calibration.

The greatest weakness of the vehicle was its power plant, the 690 hp V-12 Maybach HL 230 P 30 gasoline engine. Strained by the heavy weight with high fuel consumption, the operational range was only some 120 km (75 miles) on-road, and 80 km (50 miles) off-road. The huge case mate featured 250 mm thickness armor at the front, while the glacis plate retained the same 150 mm thickness as the King Tiger. The heavy armor added serious weight to the vehicle, and the engine proved significantly under-powered, resulting in a poor power-to-weight ratio. This resulted in strained components and caused low speed and poor off-road capability, as well as unreliability and inefficiency. These problems were so severe that most vehicles were lost due to these issues, rather than to enemy fire.

Serving on both the Eastern and Western fronts, only two heavy tank-hunter battalions received the vehicle. These were the 512th Heavy Panzerjäger Battalion and the 653rd Heavy Panzerjäger Battalion. About 20% of the Jagdtigers supplied to these units were lost due to fuel shortages and the vehicle's mechanical unreliability.

03.02.8008

## READ BEFORE ASSEMBLY

### CAUTION

- Read carefully and fully understand the instructions before commencing assembly. A supervising adult should also read the instructions if a child is assembling the model.
- When assembling this kit, tools including knives used. Extra care should be taken to avoid personal injury.
- Keep out of reach of small children. Children must not be allowed to suck any part, or pull vinyl bag over their heads.



Optional



Remove



Be Careful



Drill



Instant Glue for Metal



Do Not Cement

## PAINTS REQUIRED

Color info and profiles by Mig Jimenez

A.MIG-0204 RAL 6011 B Resedagrün	A.MIG-0211 RAL 7028 Dunkelgelb AUS 44 DG I	A.MIG-0216 RAL 8017 Schokobraun	A.MIG-0224 Rust Tracks
A.MIG-0235 Dark Tracks	A.MIG-0208 Old Wood	A.MIG-0242 Old Rust	A.MIG-0245 Gun Metal
A.MIG-0284 Crystal Glass	A.MIG-0296 Crystal Periscope Green	A.MIG-0185 Silver	A.MIG-0192 RAL 8012 Rotbraun
RLM 86 A.MIG-0215 Schwarzgrün 44 DG I	A.MIG-0237 New Wood	A.MIG-0238 Light Wood	A.MIG-0288 Crystal Black Blue
A.MIG-0202 RAL 6003 Olivgrün OPT2	A.MIG-0212 RAL 7028 Dunkelgelb AUS 44 DG II		

## APPLYING DECALS

1. Clean the model surface with a wet cloth.
2. Cut out each decal design from sheet, and dip it in tepid water for 15-20 sec.
3. Hold the backing sheet edge and slide decal onto the model.
4. Move decal into position by wetting decal with finger.
5. Press decal gently down with a soft cloth until excess water and air bubbles are gone.

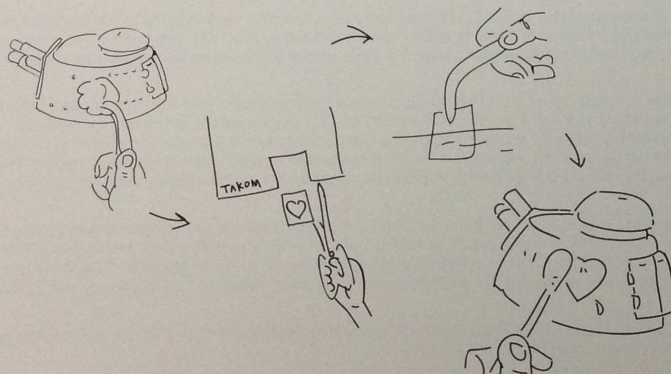

## REMOVING PE

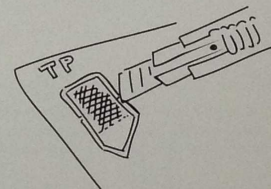

Be careful not to hurt when removing PE parts.

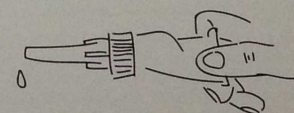

Secure using instant glue (not included).



Finish using file.



# PARTS

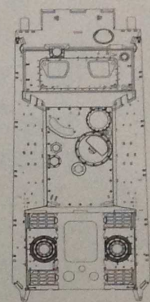
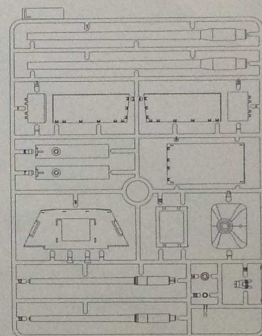
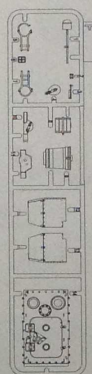
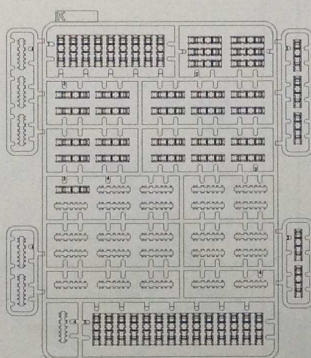
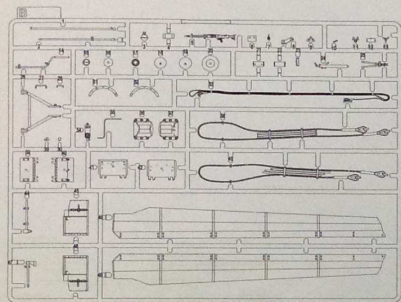

Upper Hull

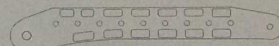
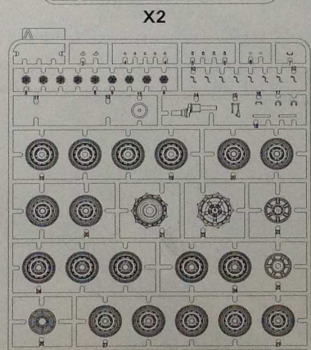
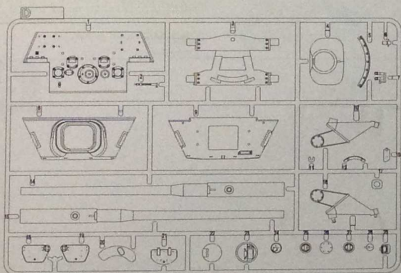

Z1

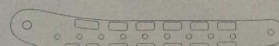

Z2

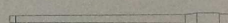

Metal Barrel

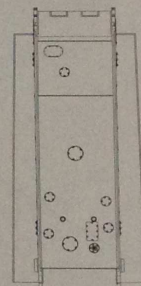

Lower Hull

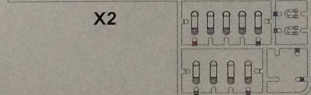
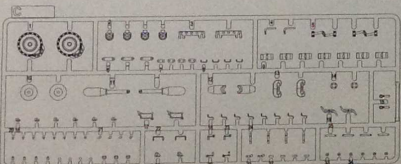

TP

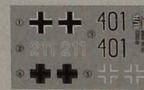

Decal

1

2

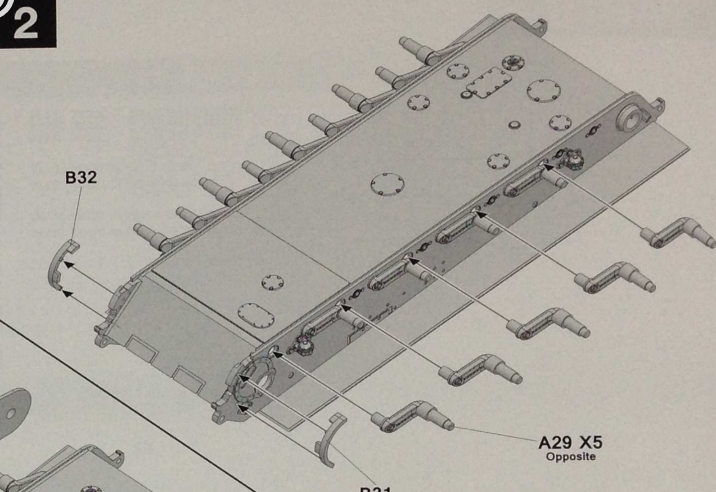
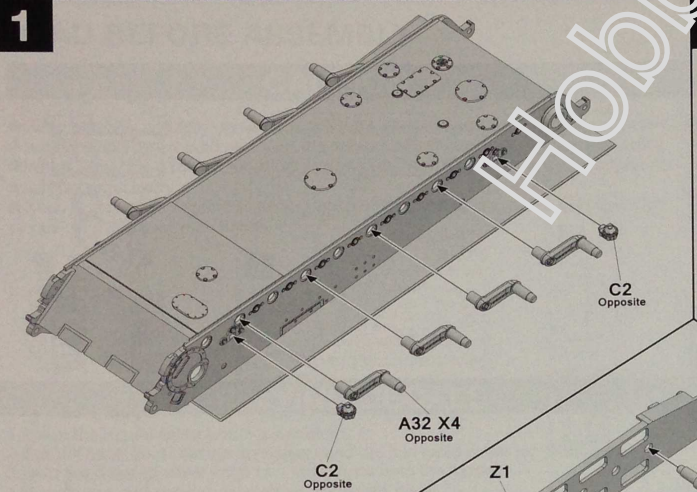

3

3

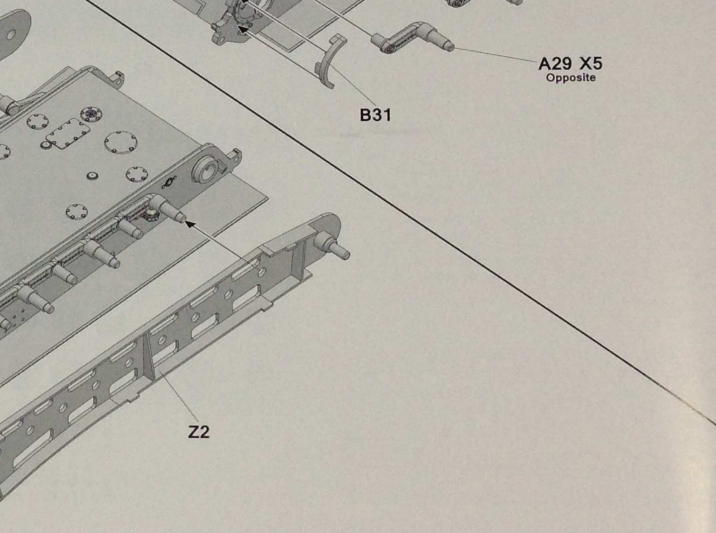
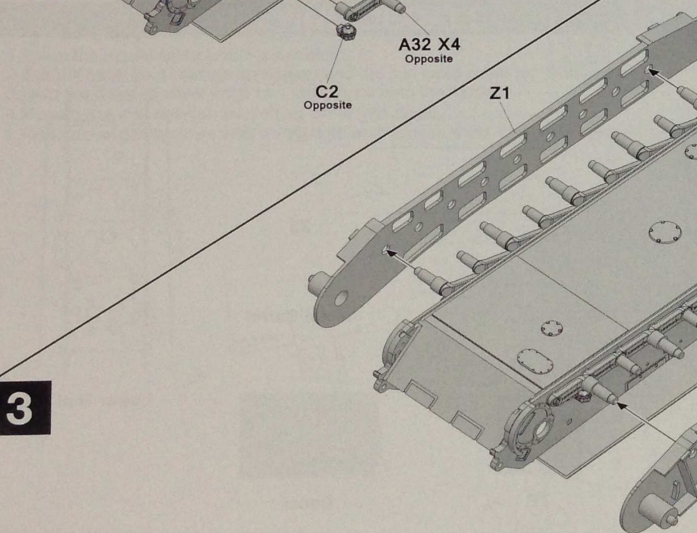







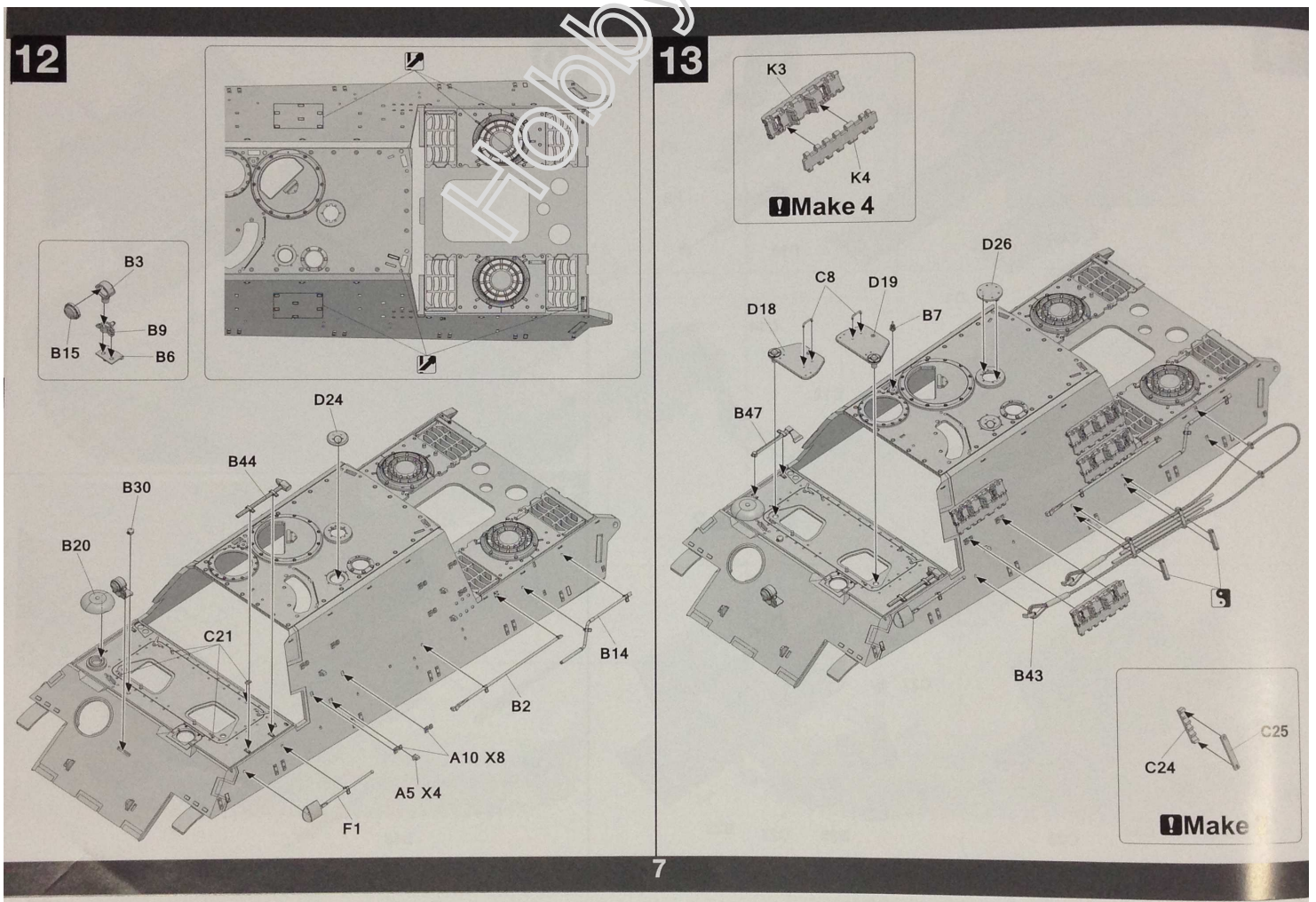
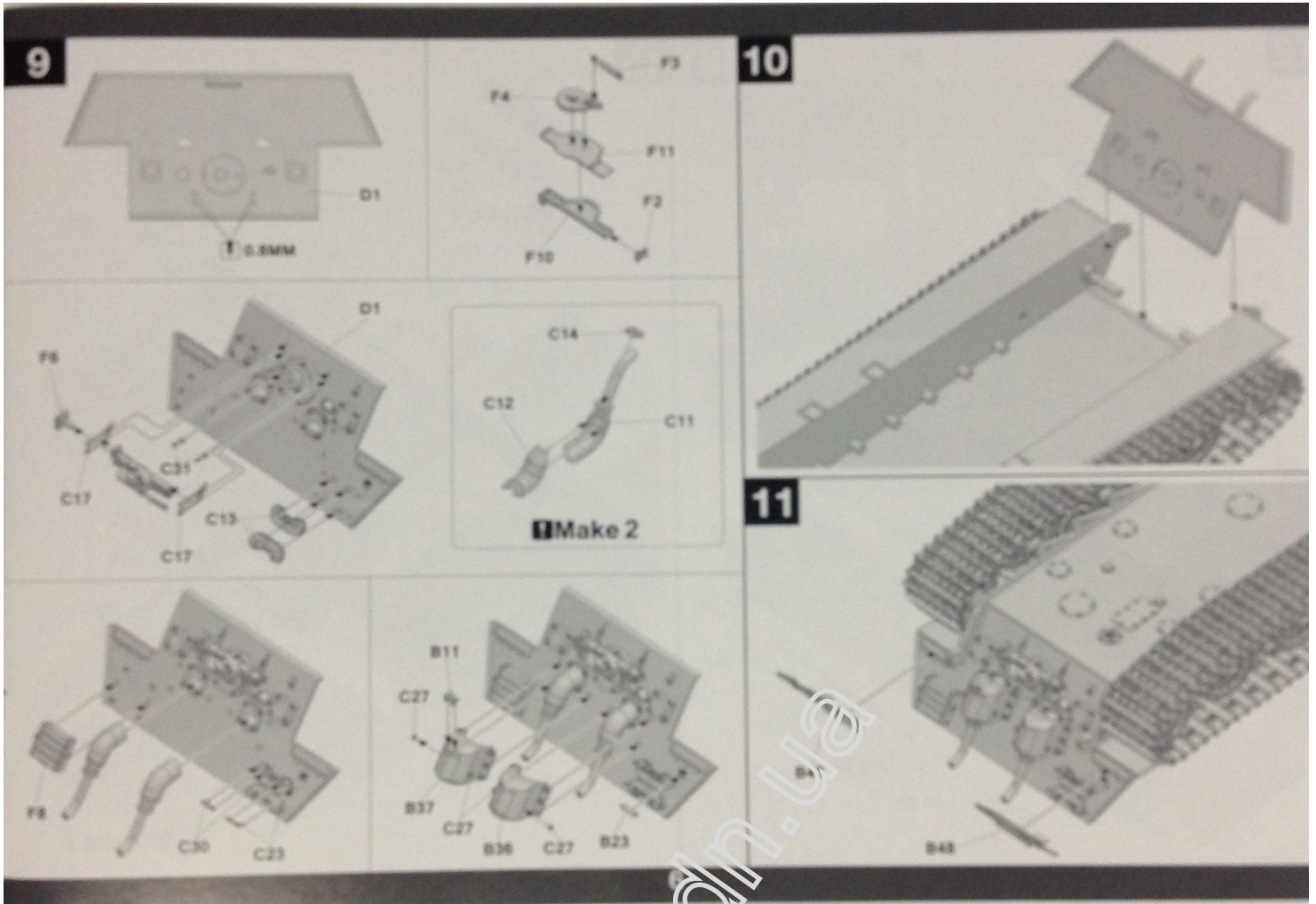



14

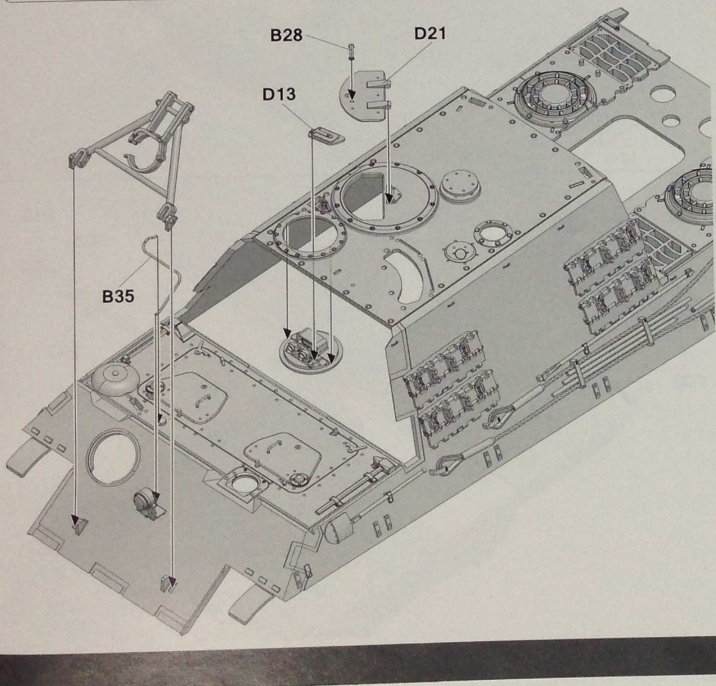
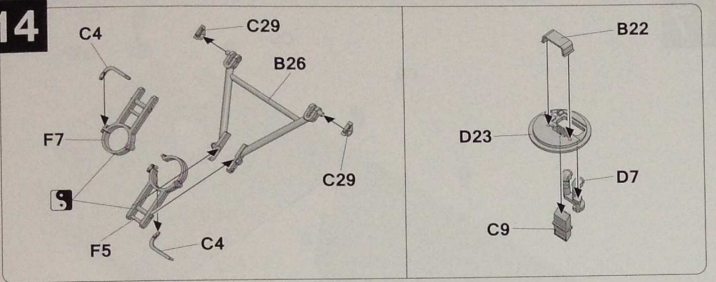

15

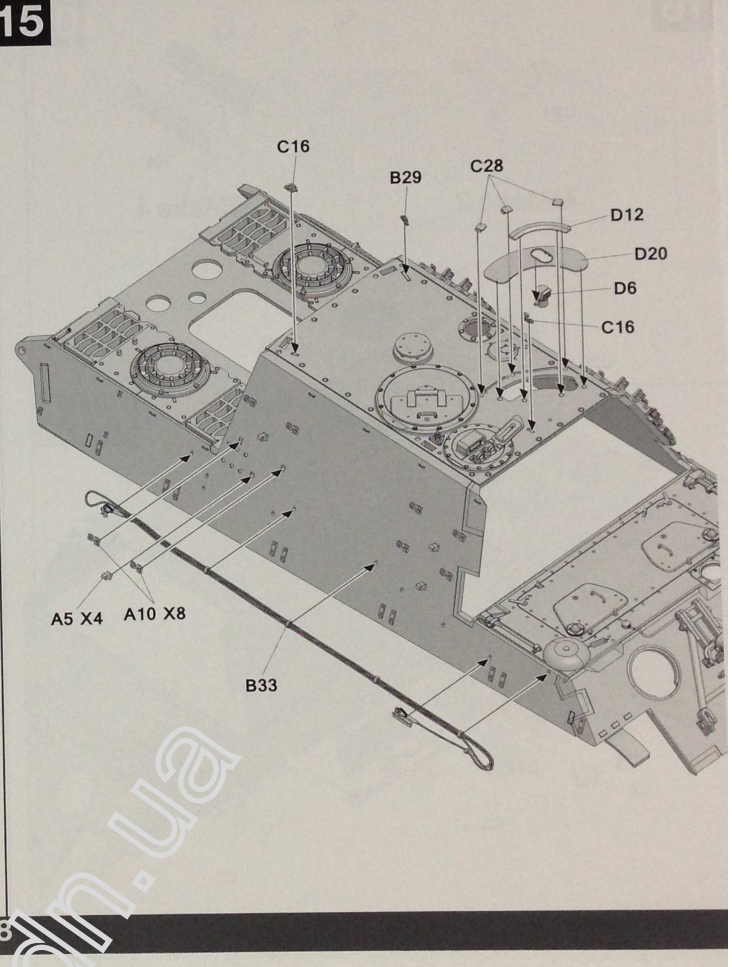

16

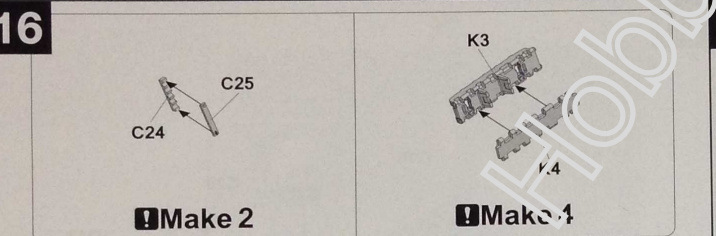

Make 2

Make 4

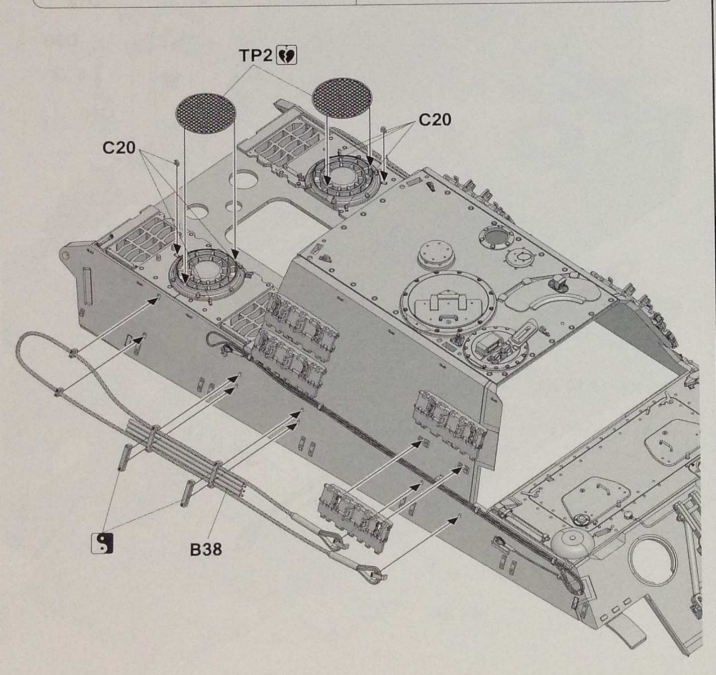

17

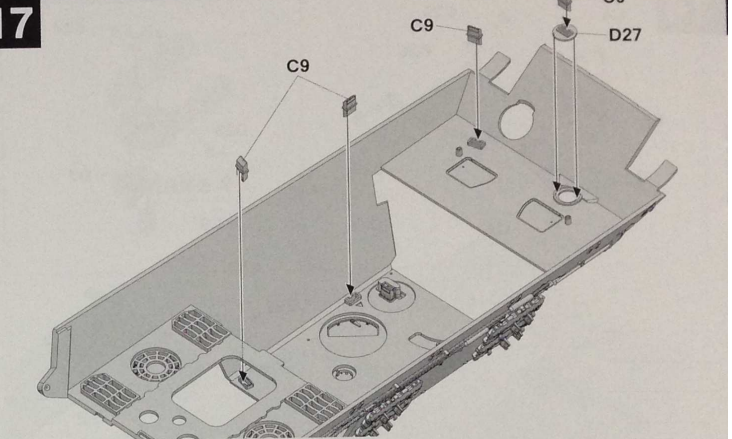

18

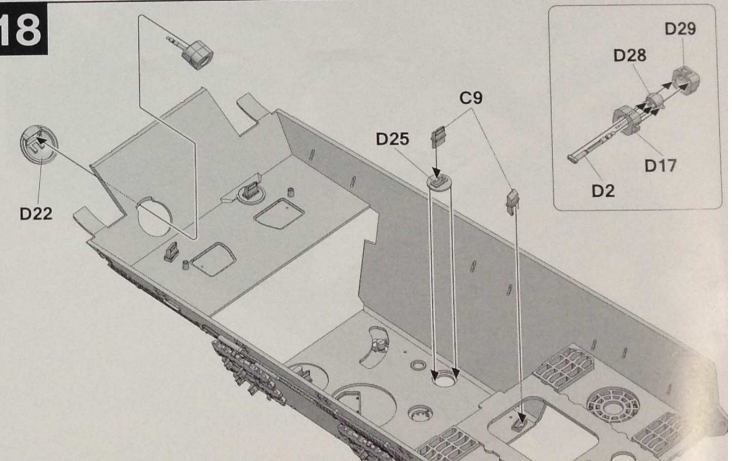



19

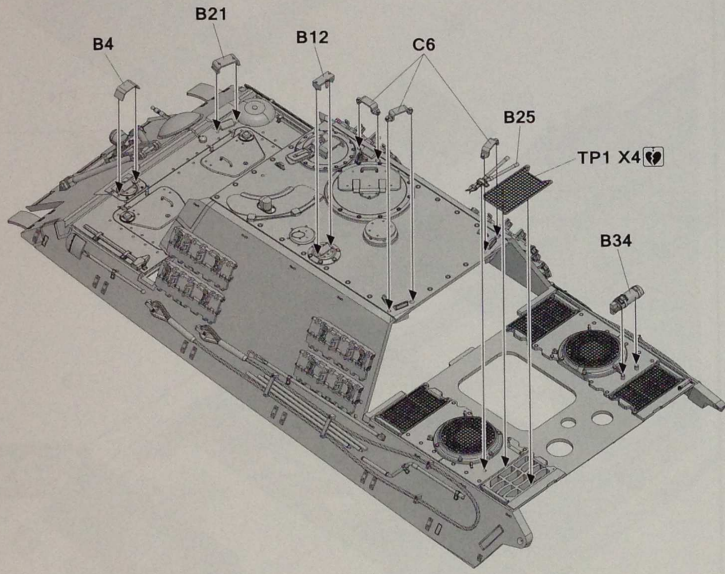

20

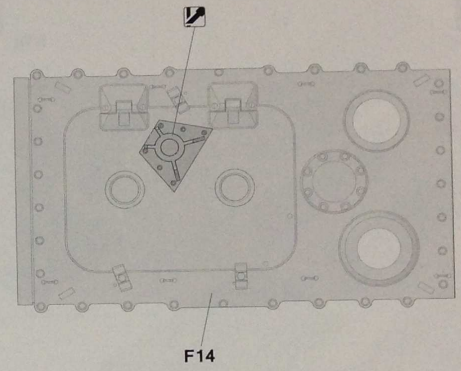

21-1

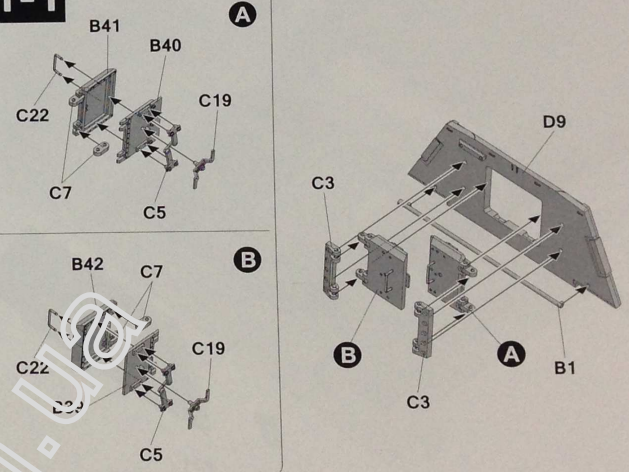

22-1

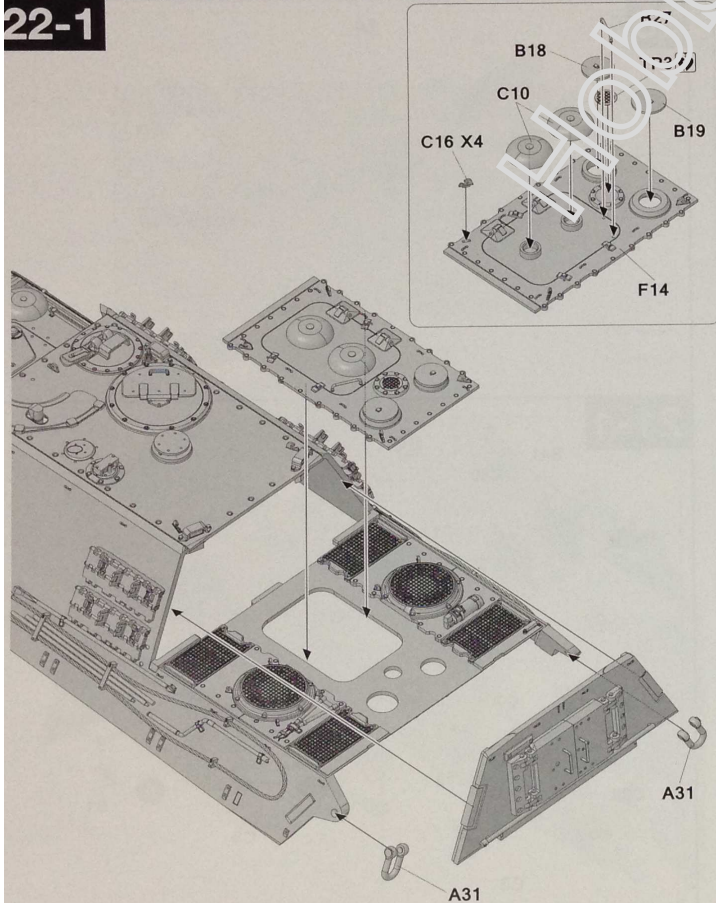

22-2

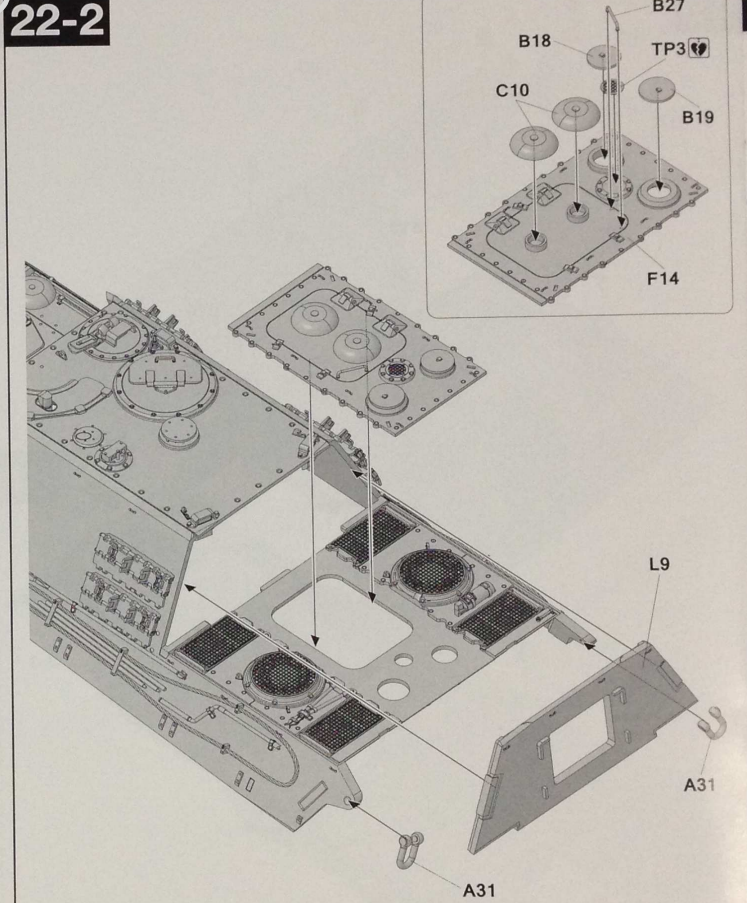



23

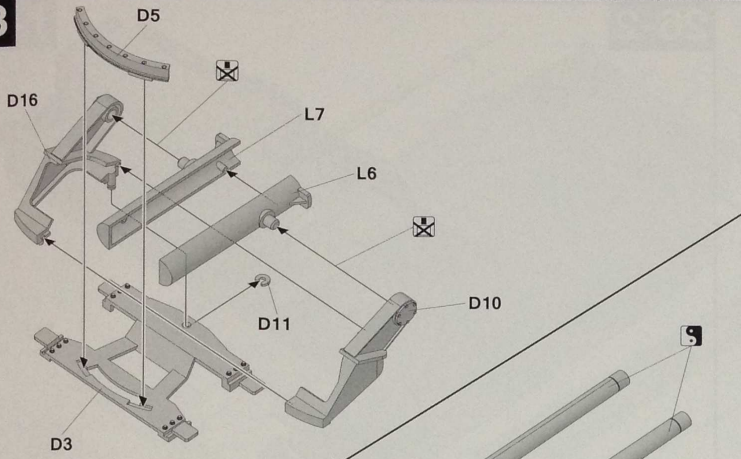

24-2

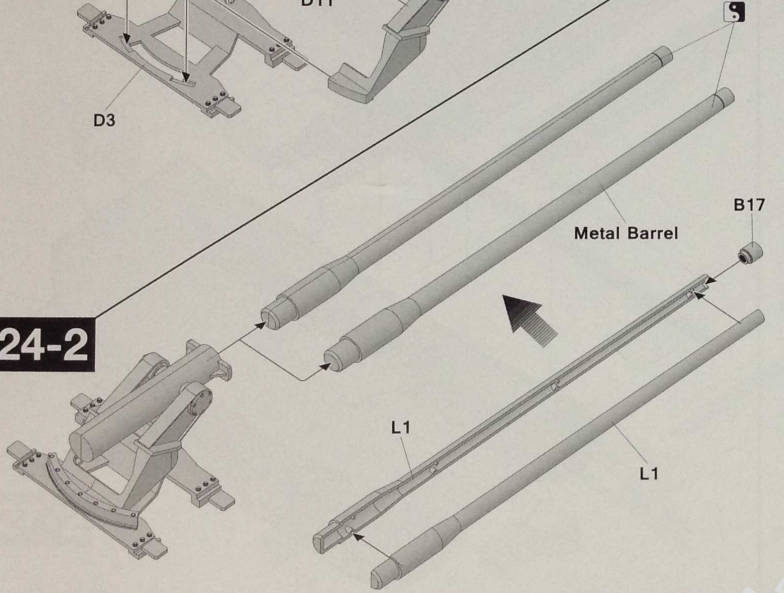

25-2

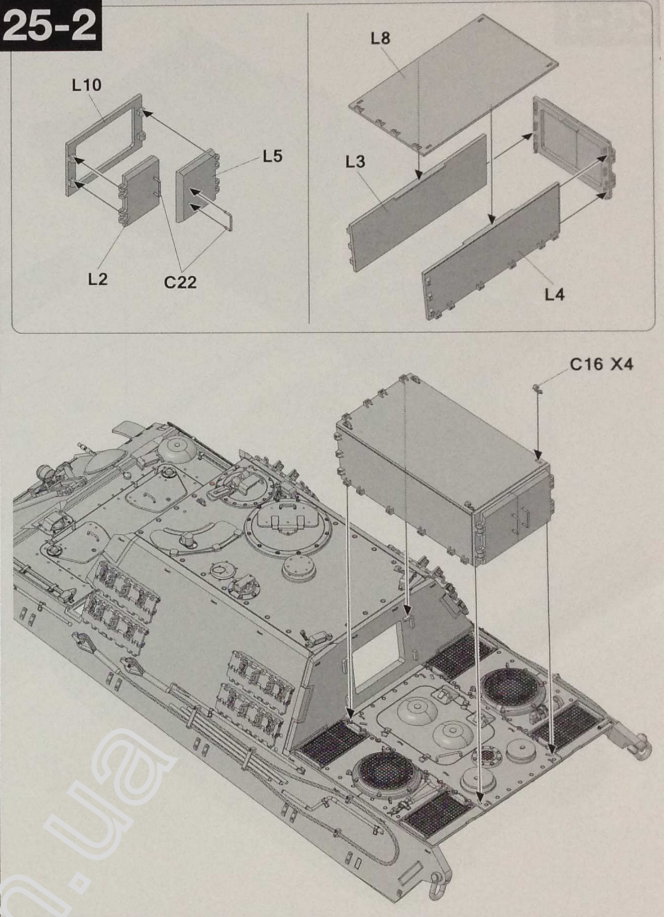

26-1

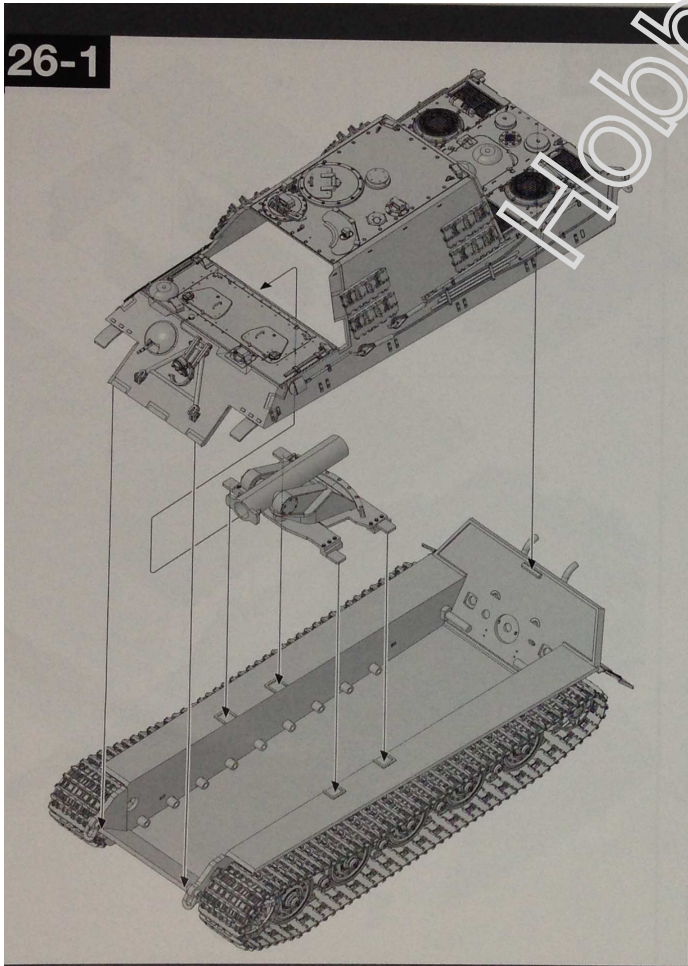

26-2

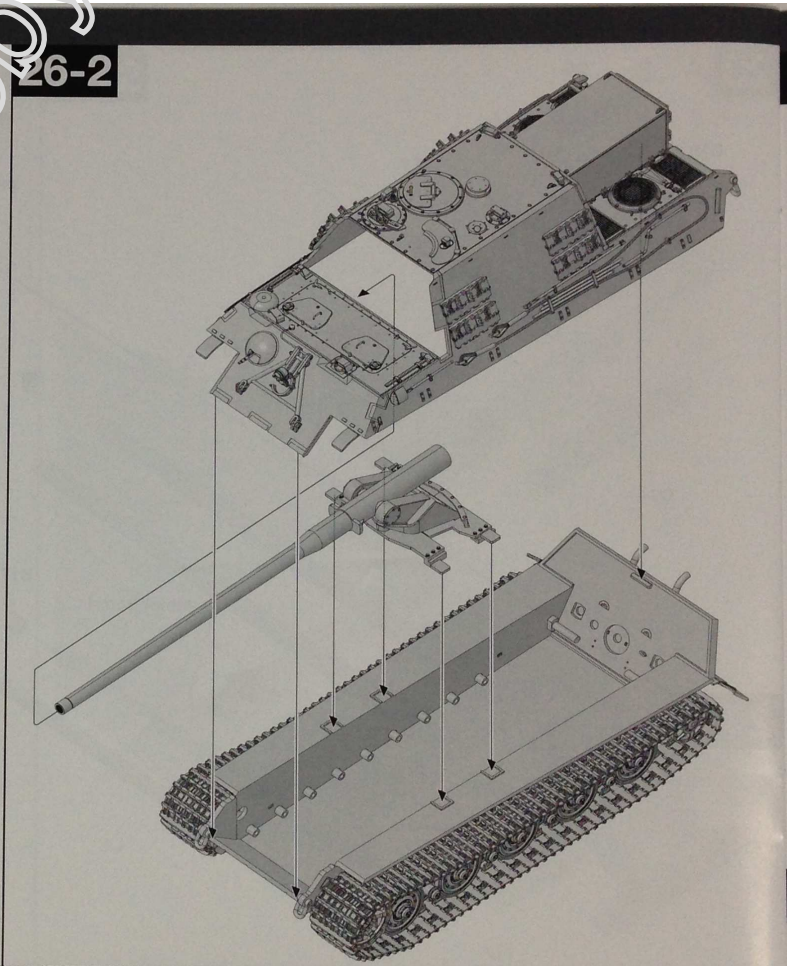



27-1

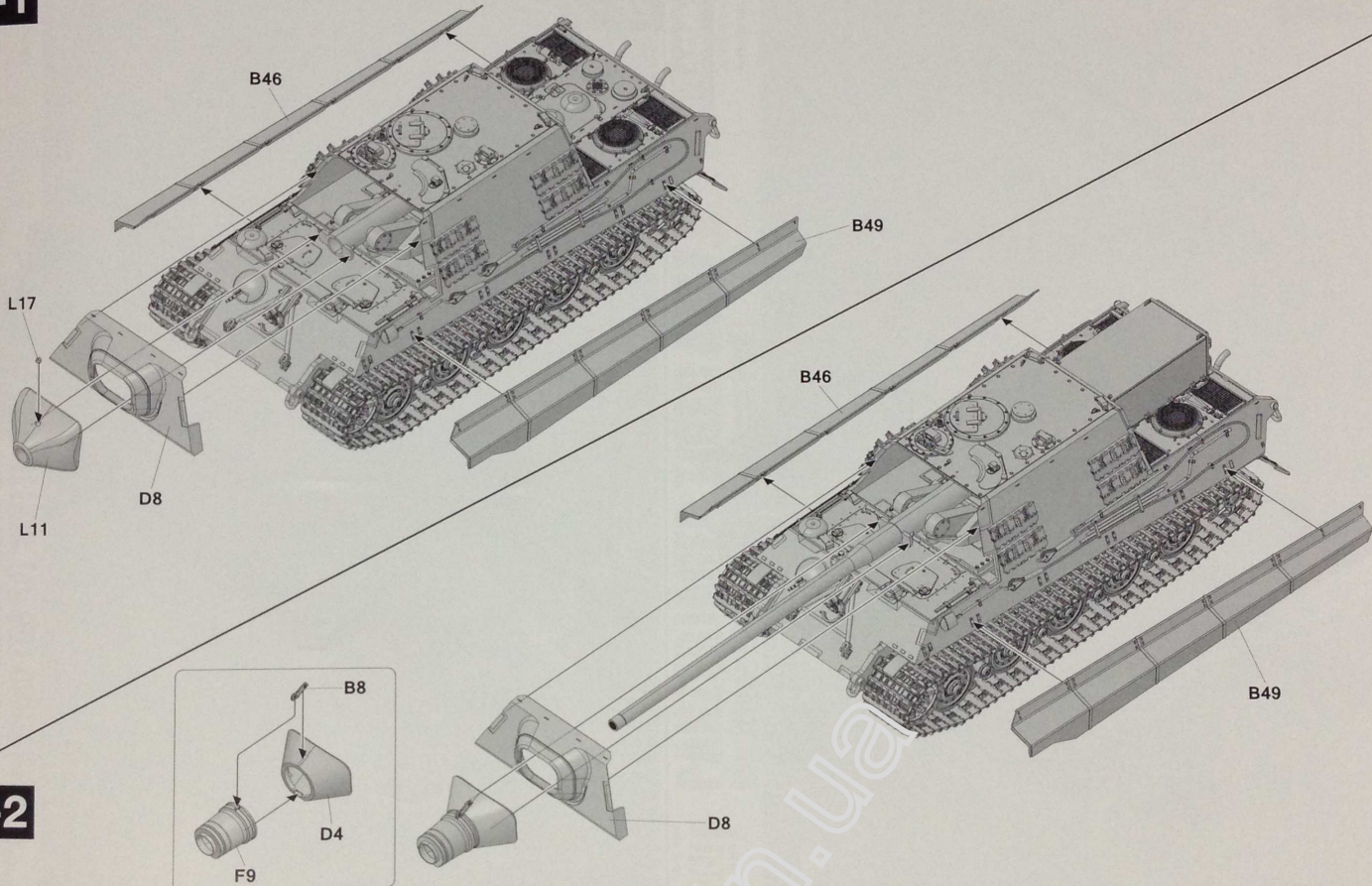

27-2

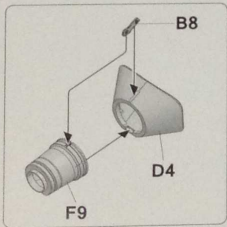

14

28-1

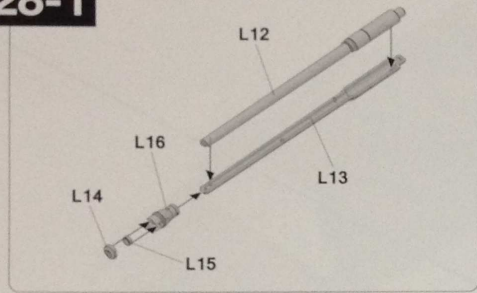

28-2

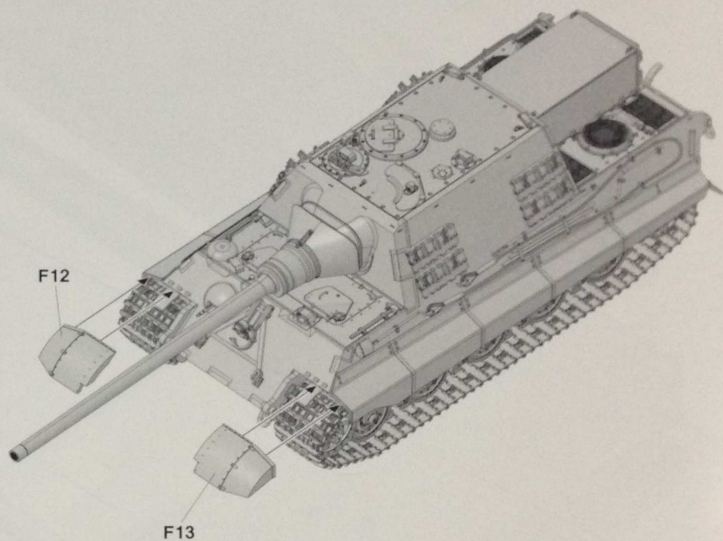
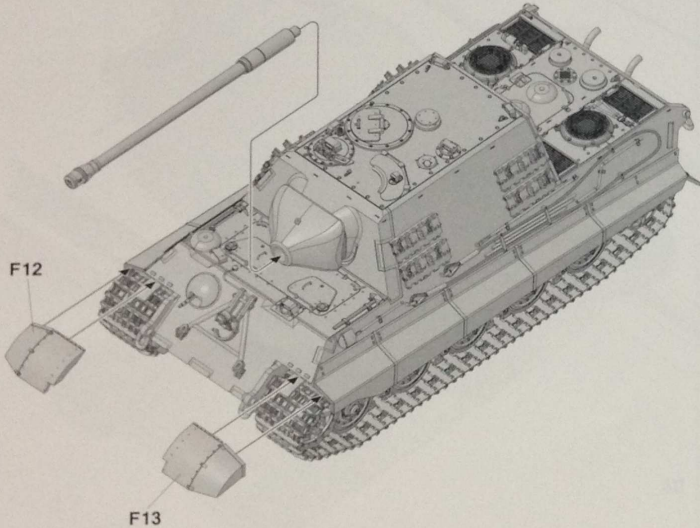

15



# PANZERJÄGER TIGER AUSE.F

## Jagdtiger (Sd.Kfz.186) (8.8cm Pak)

Painting and Marking Guide

TAKOM No 8008

Painting and Marking Guide  
Panzerjäger Tiger Ausf.B Jagdtiger  
(Sd.Kfz.186) (8.8cm Pak)  
Wehrmacht, Germany, 1945

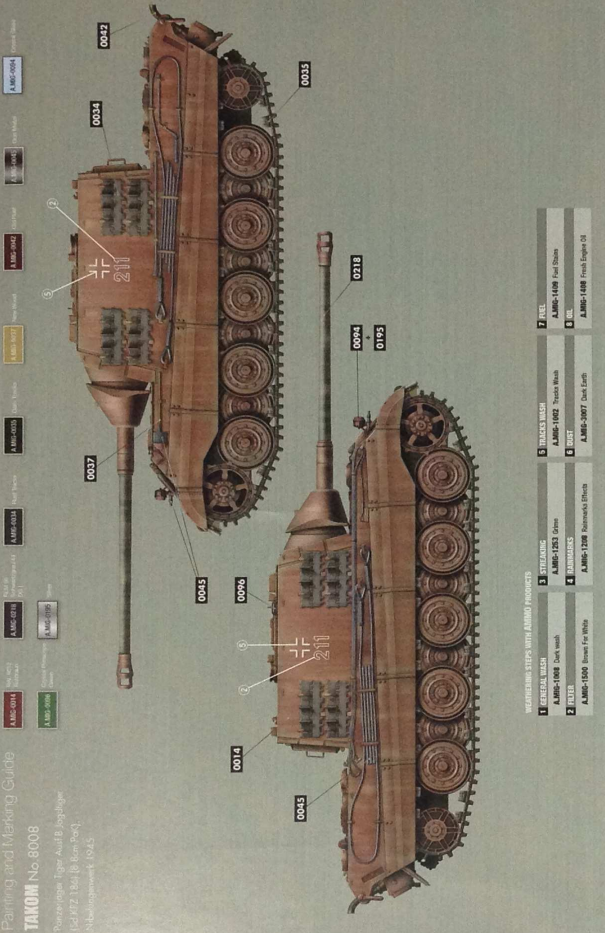

WORKING STEPS WITH AMMO PRODUCTS

1 GENERAL BLEND	5 STEELERS MARK	7 TIRE
AMMO-1408 Dark Wash	AMMO-1402 Track Wash	AMMO-1408 Fuel Station
AMMO-1409 Iron Oxide	AMMO-1403 Iron Oxide	AMMO-1408 Fresh Engine Oil
2 BLEND	6 BURNING	8 OIL
AMMO-1508 Brown Fr. Wash	AMMO-1007 Dark Earth	

# PANZERJÄGER TIGER AUSE.F

## Jagdtiger (Sd.Kfz.186) (8.8cm Pak)

Painting and Marking Guide

TAKOM No 8008

Painting and Marking Guide  
Panzerjäger Tiger Ausf.B Jagdtiger  
(Sd.Kfz.186) (8.8cm Pak)  
Wehrmacht, Germany, 1945

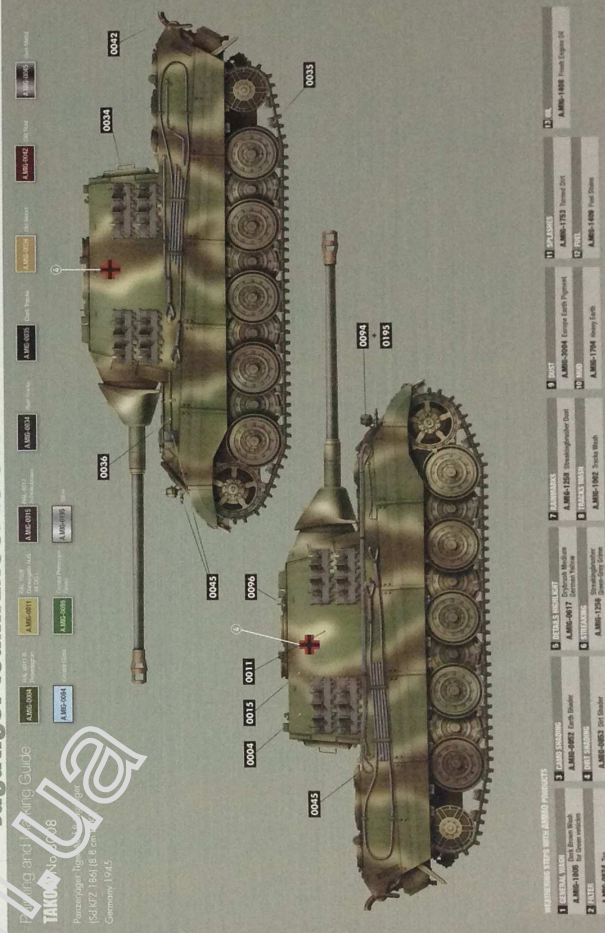

WORKING STEPS WITH AMMO PRODUCTS

1 GENERAL BLEND	5 STEELERS MARK	7 TIRE
AMMO-1408 Dark Wash	AMMO-1402 Track Wash	AMMO-1408 Fuel Station
AMMO-1409 Iron Oxide	AMMO-1403 Iron Oxide	AMMO-1408 Fresh Engine Oil
2 BLEND	6 BURNING	8 OIL
AMMO-1508 Brown Fr. Wash	AMMO-1007 Dark Earth	

# PANZERJÄGER TIGER AUSE.F

## Jagdtiger (Sd.Kfz.186) (L/66)

Painting and Marking Guide

TAKOM No 8008

Painting and Marking Guide  
Panzerjäger Tiger Ausf.B Jagdtiger  
(Sd.Kfz.186) (L/66), Germany, 1945

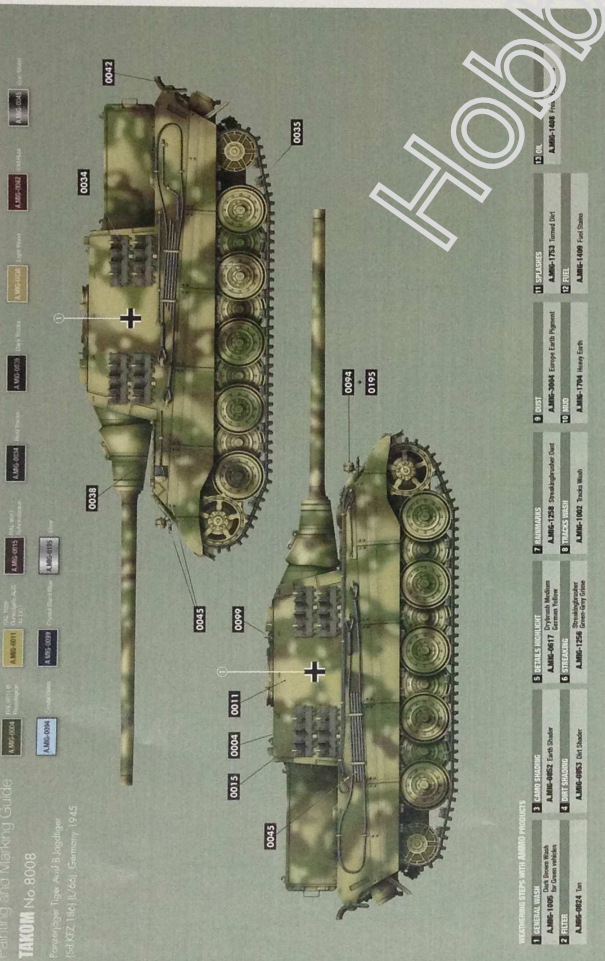

WORKING STEPS WITH AMMO PRODUCTS

1 GENERAL BLEND	5 STEELERS MARK	7 TIRE
AMMO-1408 Dark Wash	AMMO-1402 Track Wash	AMMO-1408 Fuel Station
AMMO-1409 Iron Oxide	AMMO-1403 Iron Oxide	AMMO-1408 Fresh Engine Oil
2 BLEND	6 BURNING	8 OIL
AMMO-1508 Brown Fr. Wash	AMMO-1007 Dark Earth	

# PANZERJÄGER TIGER AUSE.F

## Jagdtiger (Sd.Kfz.186) (L/66)

Painting and Marking Guide

TAKOM No 8008

Painting and Marking Guide  
Panzerjäger Tiger Ausf.B Jagdtiger  
(Sd.Kfz.186) (L/66), Germany, 1945

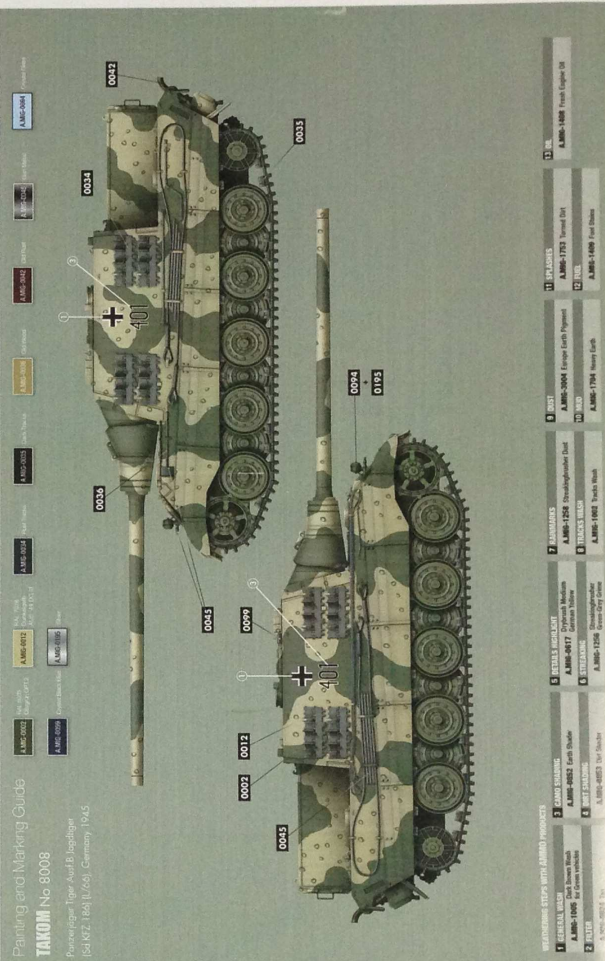

WORKING STEPS WITH AMMO PRODUCTS

1 GENERAL BLEND	5 STEELERS MARK	7 TIRE
AMMO-1408 Dark Wash	AMMO-1402 Track Wash	AMMO-1408 Fuel Station
AMMO-1409 Iron Oxide	AMMO-1403 Iron Oxide	AMMO-1408 Fresh Engine Oil
2 BLEND	6 BURNING	8 OIL
AMMO-1508 Brown Fr. Wash	AMMO-1007 Dark Earth	



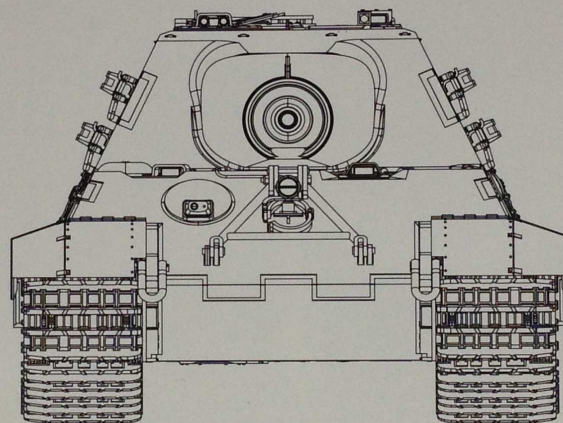

 You can find TAKOM on Facebook.com

2022/8008