

ACADEMY

HOBBY MODEL KITS

1/3412

1/72 GROUND VEHICLE SERIES-10 U.S. M977 8x8 CARGO TRUCK



미육군 M977
8x8 카고 트럭

1/72nd Scale

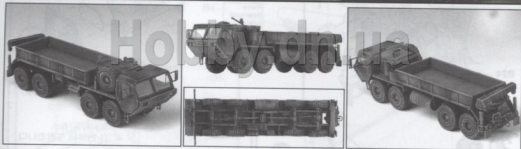

<READ THIS BEFORE YOU BEGIN>

- Study the instructions before assembling. — Check the fit of each piece before cementing into place.
- Do not use too much cement to join parts. — Never use cement or paint near open flame.
- Open a window or make sure well-ventilated when cement or paint is in use.
- Tear up and throw away the empty plastic bags to avoid danger of suffocation for little children.

<ALLGEMEINE HINWEISE>

- Die Anordnung der Bauteile ist aus den Zeichnungen der Anleitung ersichtlich.
- Die Teile vor dem Verleimen sorgfältig zusammenhalten, um einen perfekten Sitz zu prüfen.
- Klebstoff nicht zu dick auftragen. — Klebstoff und Farben niemals in die Nähe einer Flamme verwenden.
- Während der Bemalung mit Spritzpistole oder Pinsel für frische Luftzufuhr, z.B. öffnen des Fensters, sorgen.
- Basisteil von kleinen Kindern fernhalten. Verbleiben Sie, nach Kinder eigenhändig Bauteile in den Mund nehmen oder Plastiktüte über den Kopf ziehen.

■ 조립하기 전에

- 부품들 조립하기 전에 설명서를 잘 읽어보십시오.
- 부품들 지을 때에는 언제나 나사로 체결이 필요합니다.
- 접착제를 사용할 곳에 사용하지 않는 곳에 주워치고 너무 많이 사용하지 않습니다.
- 접착하기 전에 부품들 뚜껑이 확인된 후 조립합니다.
- 새우를 제외한 접착제를 사용할 때는 안전을 위해 환기를 시키고 화기를 멀리합니다.
- 새우를 낚는 부품은 어린 아이들의 손에 닿지 않도록 주의합니다.



<LISEZ CE QUI SUIT AVANT DE COMMENCER LE MONTAGE>

- Étudiez les schémas d'assemblage. — Contrôlez que chaque pièce soit bien conforme avant de la coller à sa place.
- N'utilisez pas trop de colle pour réunir les pièces. — Ne laissez manipuler la colle ou peindre à proximité d'une flamme.
- Ouvrez une fenêtre ou assurez-vous bien ventilé quand du ciment ou de la peinture est en usage.
- Après avoir utilisé les pièces de sac ou plastique, débarrassez le sac afin d'éviter que les enfants ne le mettent sur la tête ou le brûlent.

《組み立てる前に》

- 組み立てる前に説明書をお読みください。
- 部品を組むときは必ずネジで締めます。
- 接着剤を塗るときは説明書に示すように塗ってください。
- 接着剤や塗料を塗るときは換気をするようにしてください。
- 接着剤や塗料を塗った後は袋やプラスチックを捨てて、子供が袋をかぶったりしないようにしてください。

▲ 보호자 분들은 반드시 읽어 주십시오

- 조립하기 전에 취급 설명서를 잘 읽어 내용을 충분히 이해한 상태에서 조립해야 합니다.
- 부품들 지을 때는 항상 나사로 체결을 하고 지을 경우 손톱을 다치지 않도록 조심한 후 지을 것을 주의하십시오.
- 작은 부품 끼워를 할 때는 설명서대로 잘 끼워 주십시오. 잘못 끼워 넣을 경우 잘지 않게 위험할 있습니다.
- 접착제 부품은 깨끗이 닦아내고 조립하고 남은 접착제는 분리하여 잘 버려 주십시오.
- 기능성 플라스틱에 화학약품은 사용하지 않습니다.
- 제품 및 부품이 포함된 포장지는 개봉 후 즉시 어린이의 손에 닿지 않는 곳에 잘 버려 주십시오. 어린이의 접근이 불가능한 곳에 잘 버려 주십시오.
- 제품 및 접착을 위하여 포장된 도료 및 접착제 등을 사용할 때에는 환기를 잘 하고 화기를 멀리하여 주십시오. 새우를 낚는 부품은 어린 아이들의 손에 닿지 않는 곳에 잘 보관하여 주십시오.



주의

WARNING!

- Before starting to assemble, read the instruction manual very carefully to understand well everything of the instructions.
- Before cutting a part off sprue, check the part number again and use proper tool such as nipper to cut it cleanly. Take care not to be hurt in case of modelling knife to cut or trim parts.
- Never put small parts in the mouth to avoid any danger of suffocation by accidentally swallowed ones. • Never let children less than 3 years old have it to avoid any danger of taking it.
- The product may have some protruding parts for functional reasons and take care of handling it always.
- After cutting a part off sprue, trim it cleanly to assemble and the remains should be properly sorted to dispose.
- Plastic bags packed with the product and parts should be disposed in a proper place immediately to keep out of children to avoid any danger of suffocation by pulling it over head or putting it over face.
- Before using modelling colors or cement, open windows to keep the room well ventilated and do not use near fire or flame. After using them, keep in a proper place out of children.



GRINDO
 Cutter parts
 Cutter
 Paper
 Inboard
 Color
 Wheel



GRINDO
 Do not use
 Do not use
 Right side
 Right side
 Right side
 Right side
 Right side



3
3
 Right side
 Right side
 Right side
 Right side
 Right side



Star
 Star
 Star
 Star
 Star



G
G
 Right side
 Right side
 Right side
 Right side
 Right side



TRASH
 Trash
 Trash
 Trash
 Trash



GRINDO
 Cutter parts
 Cutter
 Paper
 Inboard
 Color
 Wheel



GRINDO
 Cutter parts
 Cutter
 Paper
 Inboard
 Color
 Wheel



GRINDO
 Cutter parts
 Cutter
 Paper
 Inboard
 Color
 Wheel



GRINDO
 Cutter parts
 Cutter
 Paper
 Inboard
 Color
 Wheel



GRINDO
 Cutter parts
 Cutter
 Paper
 Inboard
 Color
 Wheel



GRINDO
 Cutter parts
 Cutter
 Paper
 Inboard
 Color
 Wheel

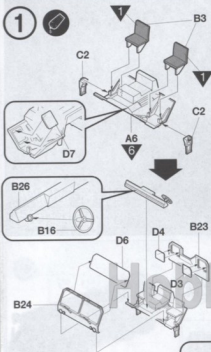

※ Attach **1** first.
 ※ **1** 번부터 조립합니다.

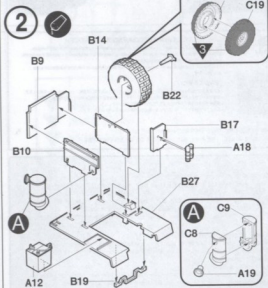
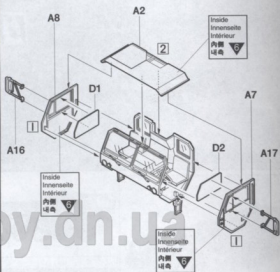

※ Attach **1** first.
 ※ **1** 번부터 조립합니다.

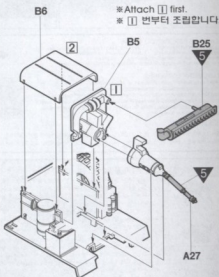

3

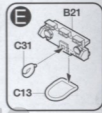
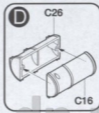
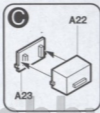
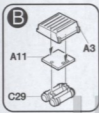
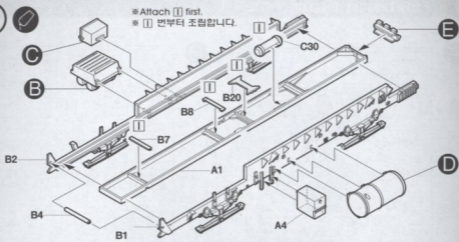

4

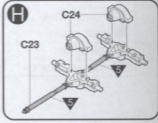
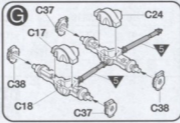
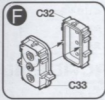
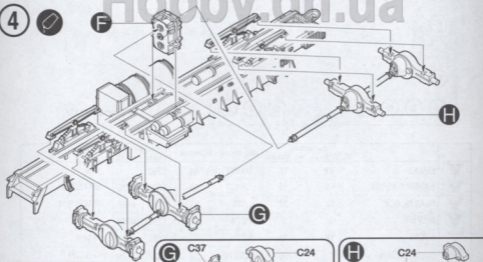

5 

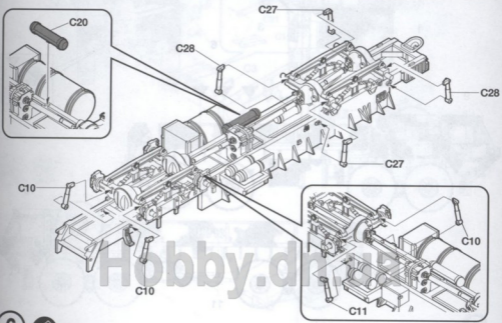
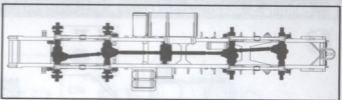

6 

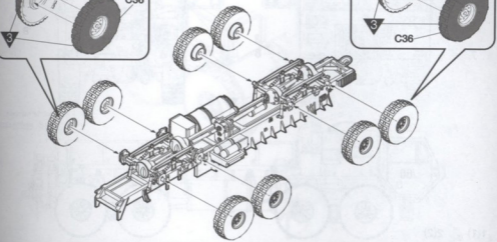
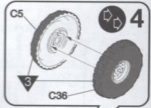
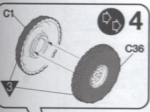

7

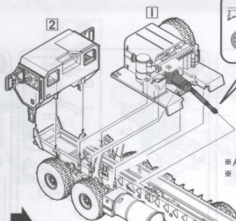
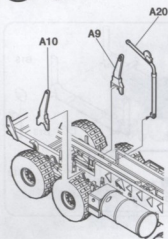

* Attach 1 first.
* 2 번부터 조립합니다.



8



B4

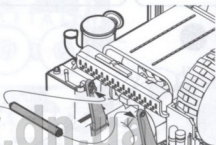

Hobby.dnru

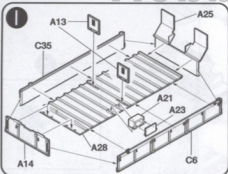

* Attach 1 first.
* 1 번부터 조립합니다.

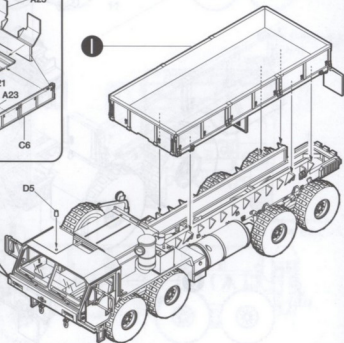
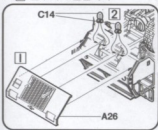

9

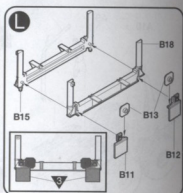
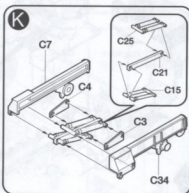
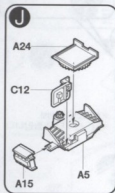

10

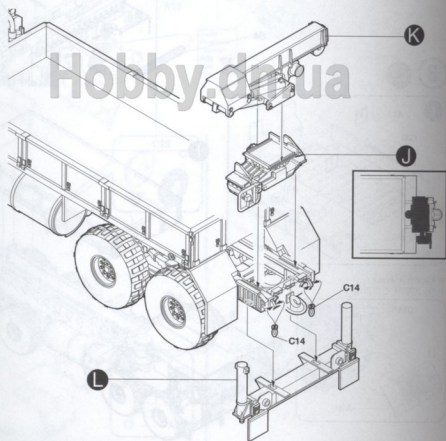

1

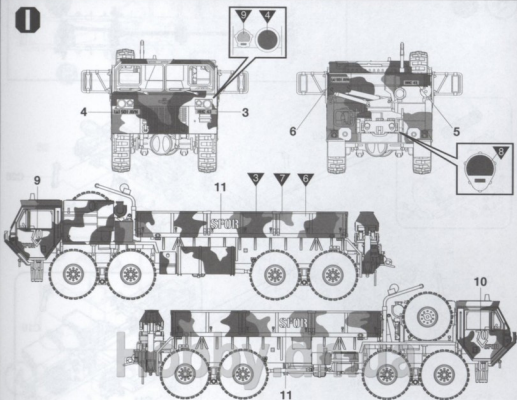

2

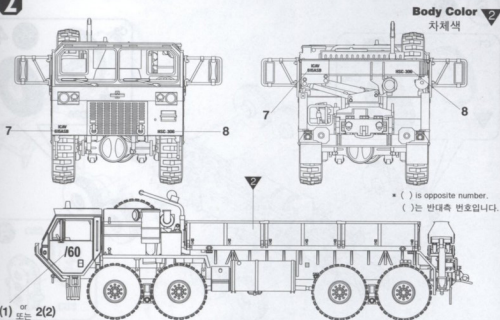

1(1) or 2(2)

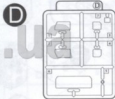
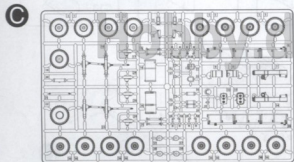
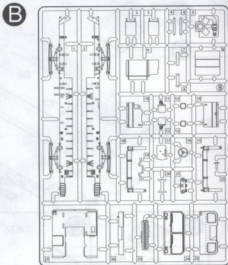
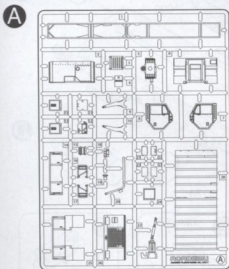

■ Decal 전사지

		GSI CREOS		LIFE COLOR	HUMBROL	MODEL MASTER		
		AQUADIP HOBBY COLOR	Mr. COLOR			ENAMEL	ACRYL	
1	KHAKI	81	55	UA097	94	1792		카키
2	SANDY BROWN	66	19	UA137	63	2053	4230	샌디브라운
3	FLAT BLACK	12	33	LC02	33	1749	4768	무광검정색
4	SILVER	8	8	LC74	11	1790	4678	은색
5	STEEL	18	28	LC76	53	1780	4679	흑철색
6	DARK GREEN		70	UA001	30	2027	4726	다크그린
7	RED BROWN	47	41	LC67	160	1701	4707	레드브라운
8	CLEAR RED	90	47		1321		4630	몰리어레드
9	CLEAR ORANGE	92	49				4625	몰리어오렌지