

WWII FIGHTER

1/48 SCALE PLASTIC KIT

#11118



INTRO

The P-39 Airacobra was developed by the Bell Aircraft Corporation in Buffalo, New York in the late 30's. The first XP-39 prototype had its maiden flight on April the 6th, 1939 in Dayton, where it reached a maximum speed of 628km/h at 6100 m, climbing to that height in only 5 minutes. The XP-39 had a very good flight performance, and specifically, good manoeuvrability thanks its original concept of airframe, with its Allison V-1710-17 1150 HP supercharged engine located in its centre of gravity. This engine location also gave the aircraft a long, slim nose well suited for installation of a powerful weapon. The USAAF ordered a test series of 12 YP-39s on April the 27th, but before the series was finished the project was significantly changed. Because of supercharger troubles, the original engine was replaced by a less powerful Allison V-1710-37 without a supercharger, and just 1090 HP. The YP-39 had an engine-axis Oldsmobile T-9 cal. 37mm cannon, two .50 calibre (12.7 mm) machine guns and two .30 calibre (7.62mm) machine guns mounted in the nose. The pilot seat got some armour, but the weight was increased to 3160 kg against 2820kg of the prototype. Because of these changes the maximum speed was decreased to 590 km/h and climb to 6100m now took 7.5 minutes. Although the excellent prototype flight performances were decreased, the Air force didn't loose interest and ordered 80 production P-39Cs. The first 20 of these were supplied as standard P-39Cs and the remaining 60 were finished as P-39Ds, with the two .30 calibre (7.62mm) machine guns moved to the wings and two more .30 calibre (7.62mm) machine guns were added to the same location. The USAAF received its first P-39Ds in February 1941, and the next order for 344 P-39D's was placed at this time.

The British RAF ordered 675 P-39's in April 1940. British Airacobra Mk.I's were produced in P-39D standard, but with the engine-axis canon replaced with a British Hispano M1 20mm cannon and the wing machine guns were replaced with 7.7mm Browning's. The first Airacobra Mk.I's were received in July 1941, but the RAF was disappointed, when it was found that they were not suitable for service in the European war theatre. In October 1941 four Mk.I's were tested by 601 Squadron in the ground attack role over occupied France, Airacobras were withdrawn from service and 212 RAF Airacobra Mk.I's were sent to Soviet Union.

When the USA came into the war, the USAAF confiscated 179 Airacobras from the British order on the production line. They were re-designated P-400, and served in the Pacific. All P-400's have 12 exhaust pipes on each side of the engine, and this was the major difference from the P-39D series. The next block of aircraft, also with 12 exhaust pipes, were 229 aircraft of the P-39F series, and after them came the P-39K series (210 aircraft), P-39L (250 aircraft), P-39M (240 aircraft) and P-39N (2095 aircraft). All these four series were very similar, using various engines, propellers and other equipment. The final version was the P-39Q with an Allison V-1710-85 engine (1420 HP), and the main difference was the installation of two .50 calibre (12.7 mm) machine guns in under-wing pods instead of the four .30 calibre (7.62mm) wing mounted machine guns in the older series. Most of the 4905 Q series aircraft were sent to Soviet Union. Production was ceased in August 1944, after the final Airacobra, number 9558, was finished.

The USAAF employed Airacobras extensively until August 1944, when they were withdrawn from front line service. The USAAF used the largest number of Airacobras, 2105 of all types, in February 1944. They served in the Pacific theatre, as well as in North Africa and Italy.

In total 4758 Airacobras were sent to Russia (actually 4924, but 166 aircraft were lost during transport) where they were very popular for their solid metal airframe and heavy weapons. The French Air Force had 165 Airacobras, and P-39's also served with the Australian RAAF, the Italian AF and the Portuguese AF. After the war a number of Airacobras were employed in civilian service and used for air races.

ÚVODEM

P-39 Airacobra byl vyvinut společností Bell Aircraft Corp. z Buffala ve druhé polovině třicátých let. Prototyp XP-39 absolvoval svůj první let 6.4.1939 v Daytonu, kde dosáhl maximální rychlosti 628 km/h ve výšce 6100m. Na tuto výšku vystoupal za pouhých 5 minut. XP-39 měl velmi dobré letové vlastnosti, mimo jiné i díky své originální konstrukci, kdy turbokompresorem vybavený motor Allison V-1710-17 o výkonu 1150 k byl umístěn v těžší letounu, v trupu za kabinou. Toto umístění motoru také uvolnilo předí pro instalaci silné výzbroje. 27.dubna USAF objednalo zkušební sérii 12 YP-39, ale před jejím dokončením byl projekt významně upraven. Pro potíže s turbokompresorem byl původní motor nahrazen motorem Allison V-1710-37 bez turbokompresoru, dávajícím jen 1090 k. Mezi bloky válců byl namontován kanon Oldsmobile T-9 ráže 37mm, střelící dutým hřídelem vrtule, do předí byly instalovány dva kulometry ráže 12,7 mm a dva ráže 7,7 mm. Pilotovo sedadlo dostalo pancéřování, ale hmotnost vzrostla na 3160kg oproti 2820kg prototypu. Rychlost poklesla na 590 km/h a výstup na 6100m nyní trval 7,5 minuty. Přestože výkony stroje poklesly, USAAF neztratilo zájem a objednalo 80 produkčních P-39C. Z nich bylo 20 dodáno skutečně jako P-39C, zbylých 60 pak bylo upraveno na standard verze D, se dvěma kulometry ráže 12,7 mm v předí a čtyřmi kulometry ráže 7,62 instalovanými v křídle. USAAF dostalo své první P-39D v únoru 1941 a objednalo dalších 344 kusů. Britové objednali v dubnu 1940 675 Airacober. Byly dodány v červnu 1941. Odpovídaly verzi D upravené podle britských požadavků. Kanon Oldsmobile byl nahrazen kanonem Hispano M1 ráže 20 mm, a křídelní kulometry byly britské Browning ráže 7,7 mm. RAF testovalo čtyři Airacobery Mk.I v bojových podmínkách u 601.squadrony v říjnu 1941(kde si je vyzkoušeli i někteří čs.piloti), ale byli zklamáni jejich výkony. Zbylých 212 Airacober Mk.I pak bylo posláno do Ruska a předáno sovětskému letectvu.

Po vstupu USA do války, 179 britských Airacober bylo konfiskováno na výrobní lince. Stroje byly označeny P-400 a bojovaly většinou v Pacifiku. Všechny P-400 měly 12 výfukových nátrubků na každé straně motoru, což je jejich hlavní rozlišovací znak od P-39D.V dodávkách následoval blok 229 letadel verze P-39F, také s 12 výfukovými nátrubky, po něm pak verze P-39K (210 letadel), P-39L (250 letadel), P-39M (240 letadel) a velký blok 2095 letadel verze P-39N. Všechny čtyři tyto série si byly velmi podobné, používaly různé motory, vrtule a další vybavení. Poslední a nejrozšířenější verzí byla verze P-39Q, vybavená motorem Allison V-1710-85 o výkonu 1420 k. Její největším vnějším rozdílem oproti předchozím verzím bylo nahrazení čtyř křídelních kulometů dvěma kulometry ráže 12,7 mm, instalovaných v gondolkách pod křídly. Většina z 4905 P-39Q byla dodána do Sovětského svazu. Produkce byla ukončena v srpnu 1944 po dokončení poslední, 9558. Airacobery.

USAAF používalo Airacobery v první linii do srpna 1944, kdy byly staženy z frontové služby. Nejvíce Airacober, celkem 2105 letadel všech verzí, mělo USAAF ve službě v únoru 1944. Sloužily v Pacifiku, v severní Africe, Itálii i na domácích základnách.

Celkem 4758 (4924, ale 166 bylo ztraceno během přepravy) Airacober bylo dodáno Sovětskému svazu. V sovětském letectvu byly Airacobery velmi populární pro jejich robustní konstrukci a silnou výzbroj. Francouzské letectvo mělo 165 Airacober různých verzí, a P-39 byly v menších počtech používány i letectvy Austrálie, Itálie a Portugalska. Jeden kus se po válce vyskytoval i v polském letectvu. Po válce byla řada Airacober používána v civilních službách, mimo jiné jako závodní stroje. Jednu z nich vlastnil např. Miro Slovak.



Carefully read instruction sheet before assembling. When you use glue or paint, do not use near open flame and use in well ventilated room. Keep out of reach of small children. Children must not be allowed to suck any part, or pull vinyl bag over the head.



Před započítím stavby si pečlivě prostudujte stavební návod. Při používání barev a lepidel pracujte v dobře větrané místnosti. Lepidla ani barvy nepoužívejte v blízkosti otevřeného ohně. Model není určen malým dětem, mohlo by dojít k požití drobných dílů.

INSTRUCTION SIGNS

INSTR. SYMBOLS

INSTRUKTION SINNBILDEN

SYMBOLES

記号の説明



OPTIONAL
VOLBA



BEND
OHNOU



OPEN HOLE
VYVRTAT OTVOR



SYMMETRICAL ASSEMBLY
SYMETRICKÁ MONTÁŽ



REMOVE
ODŘÍZNOUT



REVERSE SIDE
OTOČIT



APPLY EDUARD MASK
AND PAINT
POUŽÍTE EDUARD MASK
NABARVIT

PARTS



DÍLY



TEILE



PIÈCES



部品

PLASTIC PARTS

A> 2 pcs.

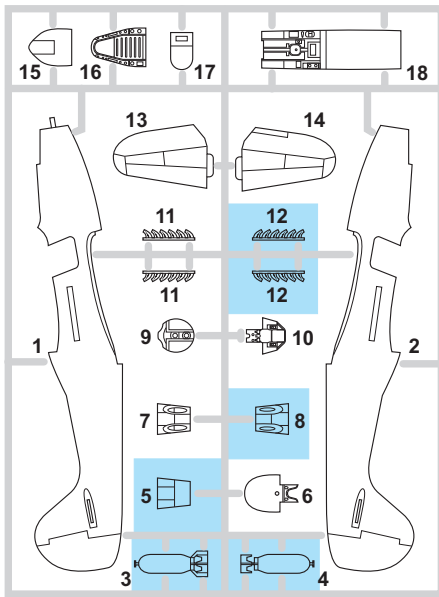

B> 2 pcs.

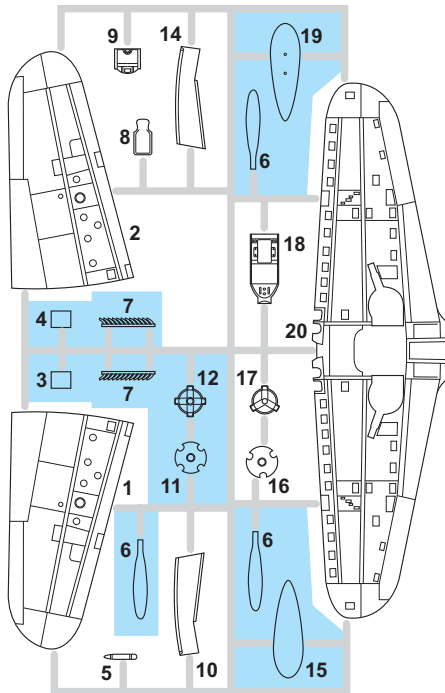

C> 2 pcs.

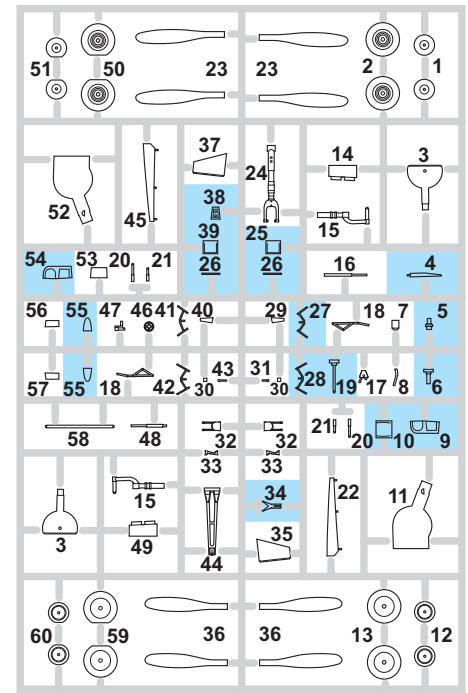

2 pcs.

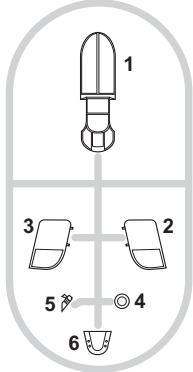

FILM

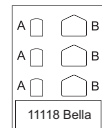

eduard
MASK

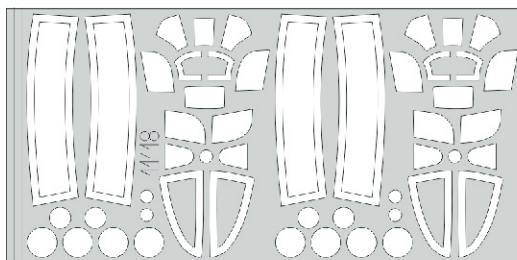

PE - PHOTO ETCHED DETAIL PARTS

2 pcs.

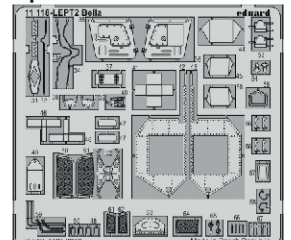
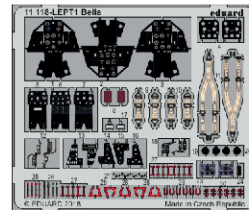

-Parts not for use. -Teile werden nicht verwendet. -Pièces à ne pas utiliser. -Tyto díly nepoužívejte při stavbě. - 使用しない部品

COLOURS



BARVY



FARBEN



PEINTURE



色

GSI Creos (GUNZE)		MISSION MODELS	
AQUEOUS	Mr.COLOR	PAINTS	
H3	C3	MMP-003	RED
H4	C4	MMP-007	YELLOW
H8	C8		SILVER
H11	C62	MMP-001	FLAT WHITE
H12	C33	MMP-047	FLAT BLACK
H52	C12	MMP-091	OLIVE DRAB
H53	C13		NEUTRAL GRAY
H58	C351	MMP-087	INTERIOR GREEN
H67	C115	MMP-057	LIGHT BLUE
H72	C22		DARK EARTH
H77	C137	MMP-040	TIRE BLACK
H303	C303	MMP-066	GREEN

GSI Creos (GUNZE)		MISSION MODELS	
AQUEOUS	Mr.COLOR	PAINTS	
H304	C304	MMP-026	OLIVE DRAB
H331	C331		DARK SEAGRAY
H417	C117	MMP-051	LIGHT BLUE
H422	C122	MMP-053	LIGHT GREEN
	C74	MMP-061	AIR SUPERIORITY BLUE
	C97		LIGHT GRAY
Mr.METAL COLOR		METALLICS	
	MC214	MMM-001	DARK IRON
	MC218	MMM-003	ALUMINIUM
Mr.COLOR SUPER METALLIC		METALLICS	
	SM01	MMC-001	SUPER CHROME

MARKINGS E, F, H ONLY

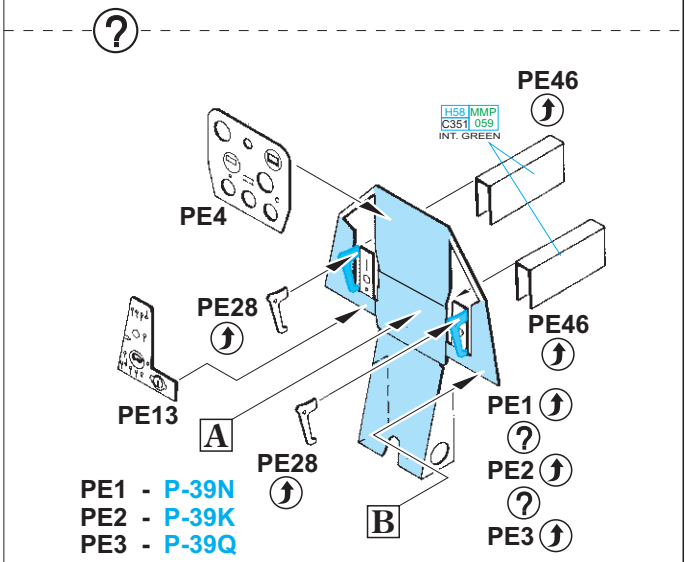
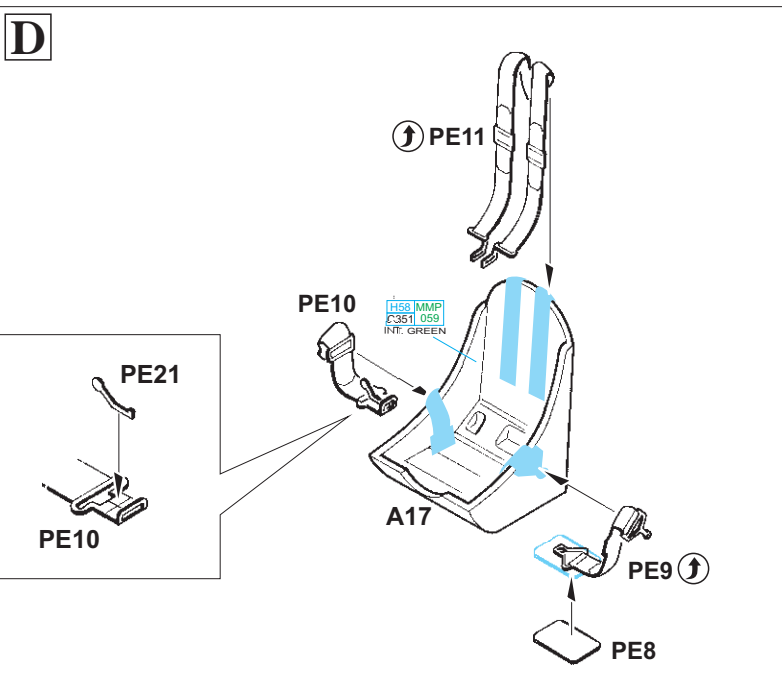
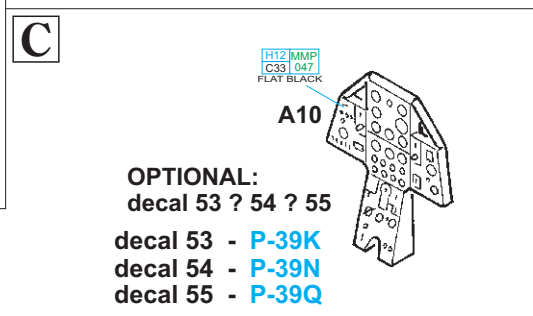
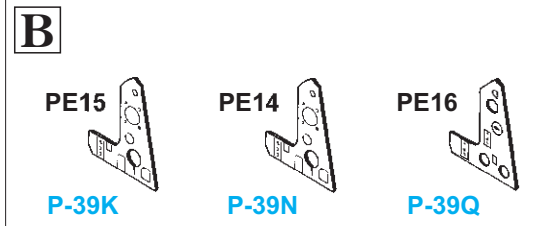
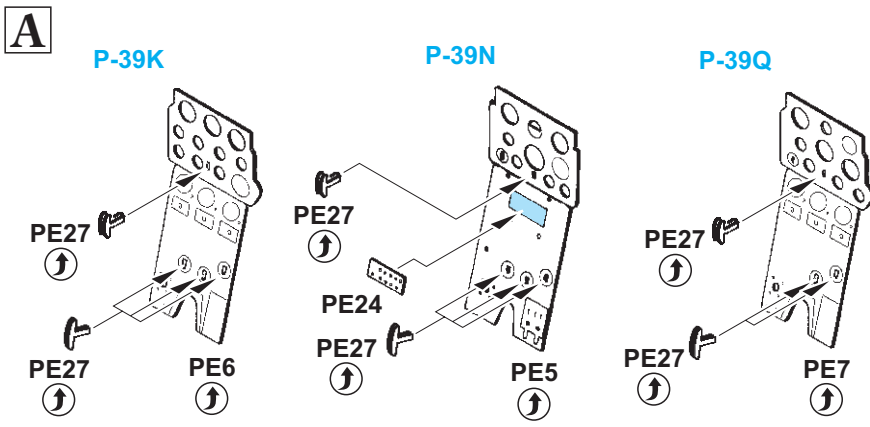
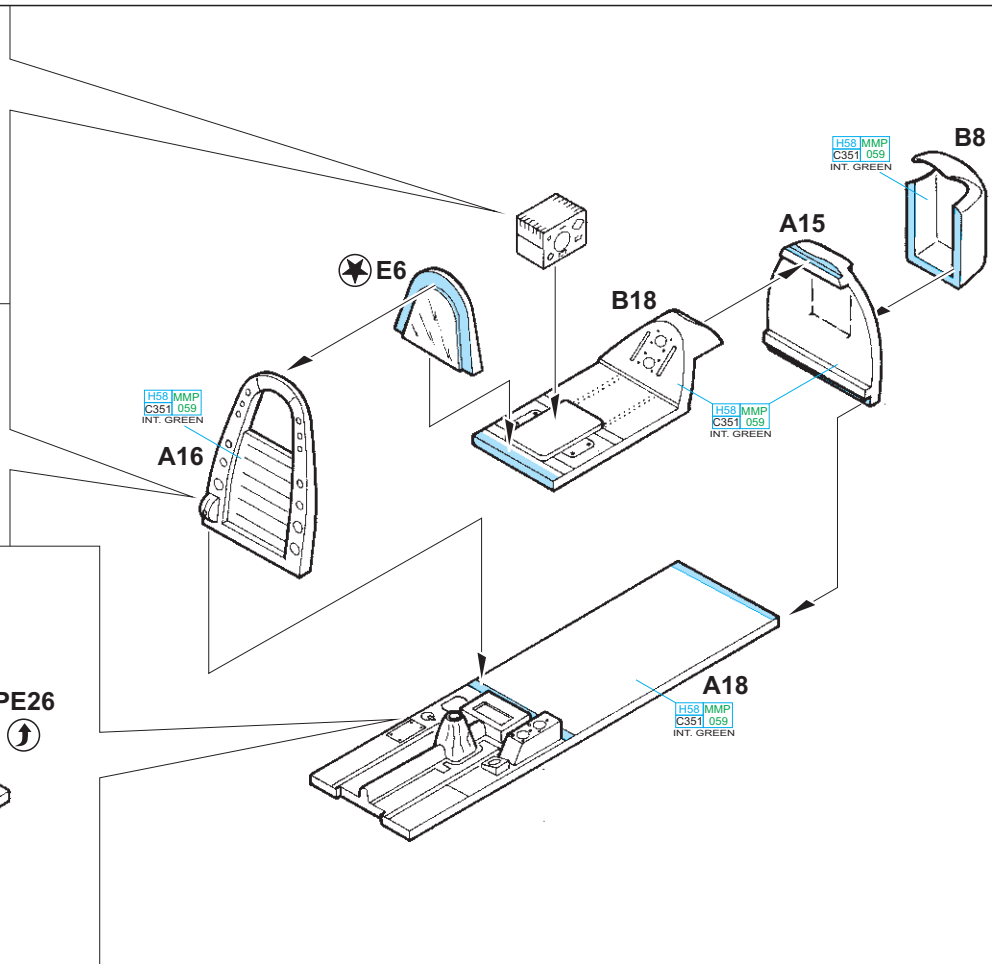
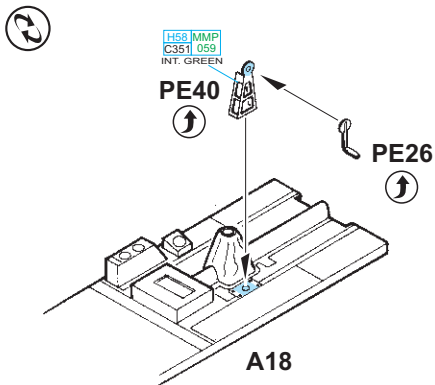
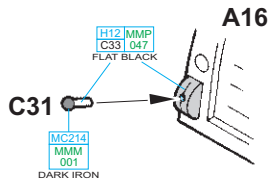
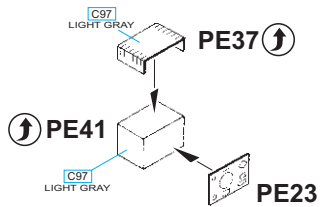

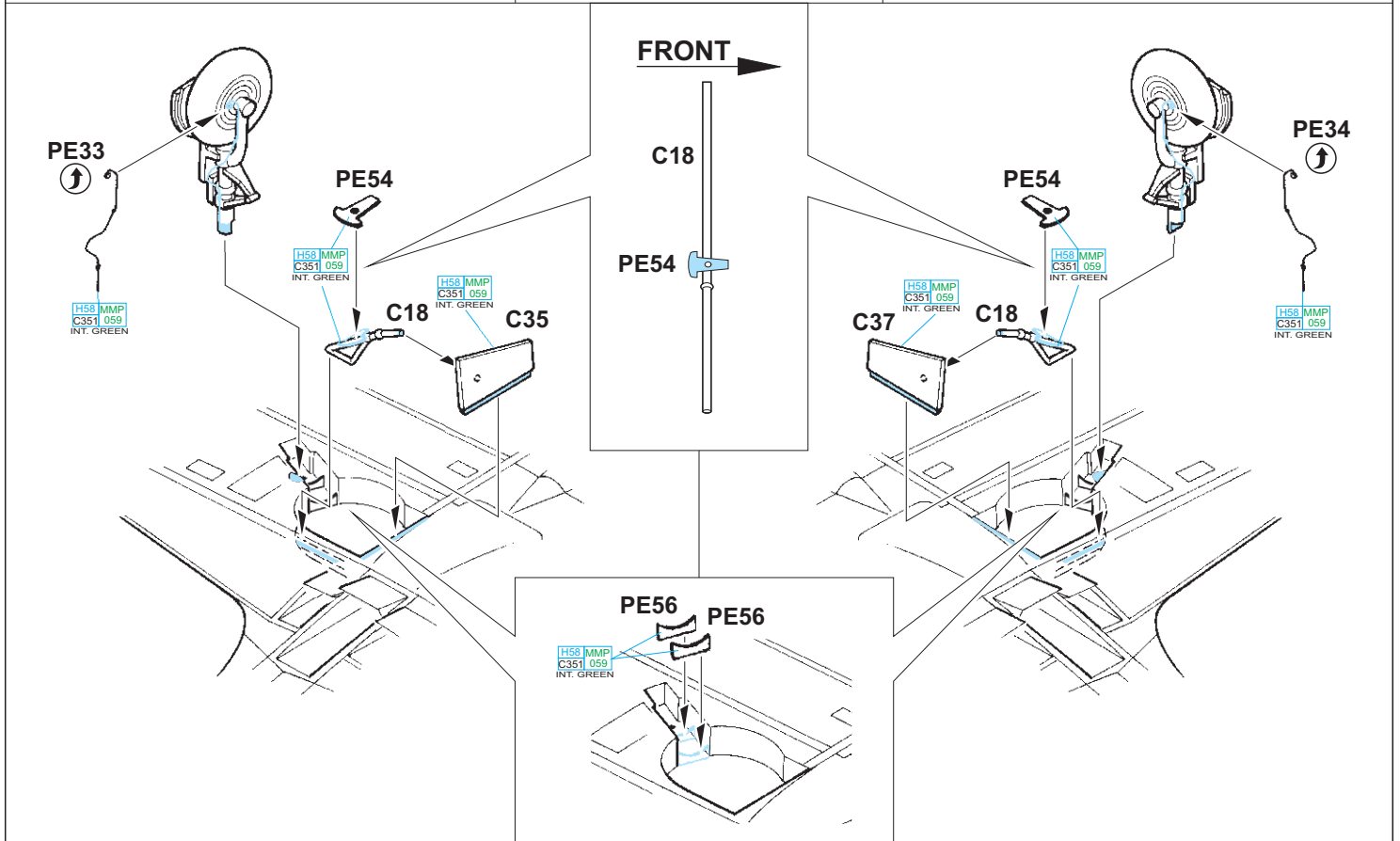
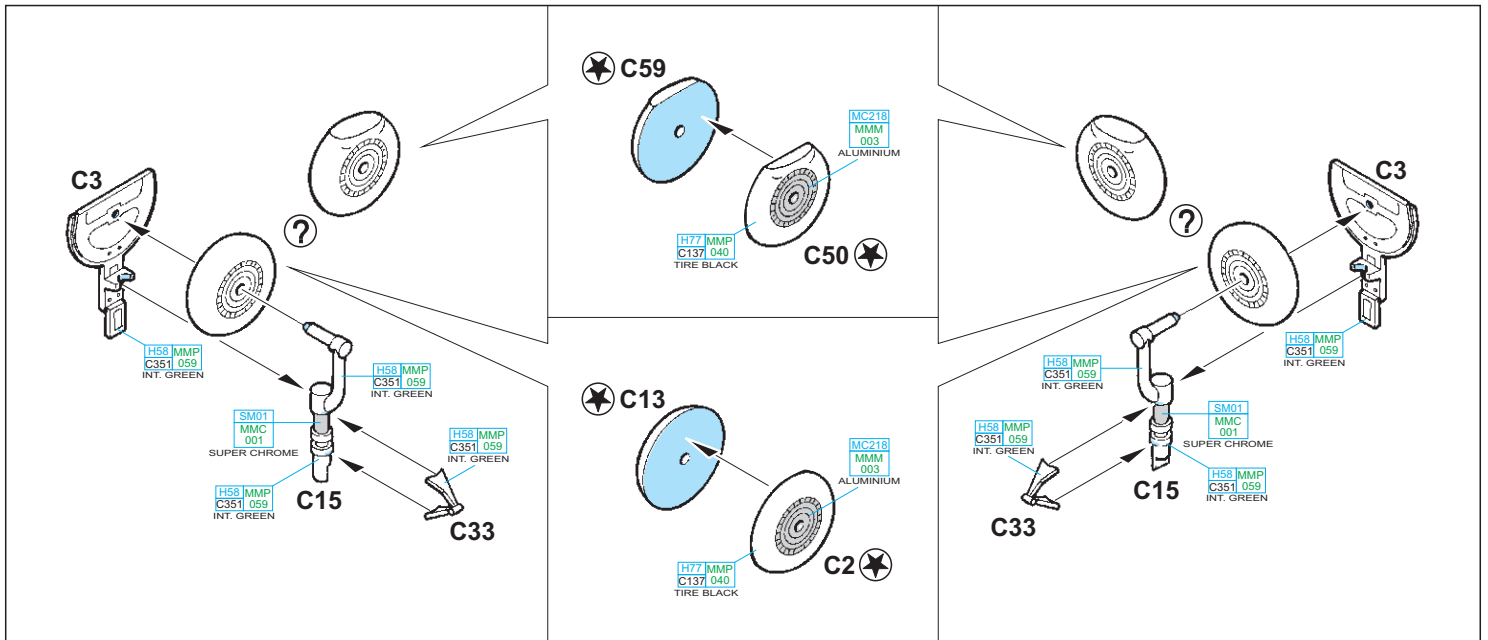

MARKING  ONLY

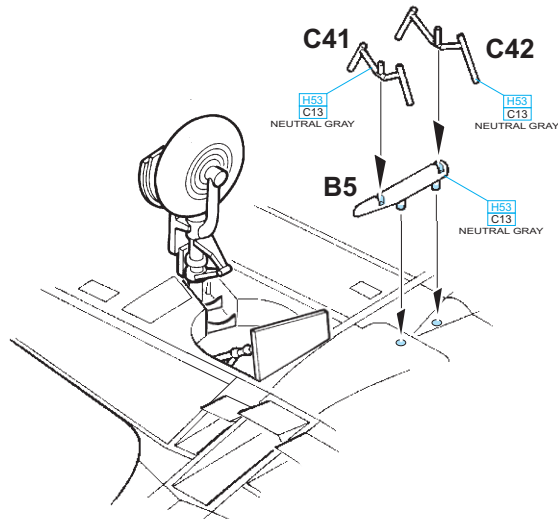

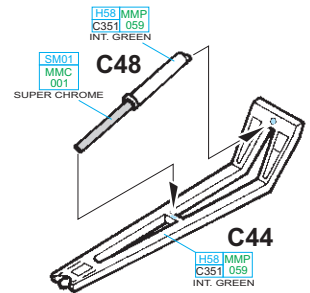
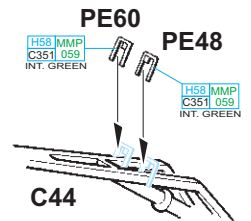
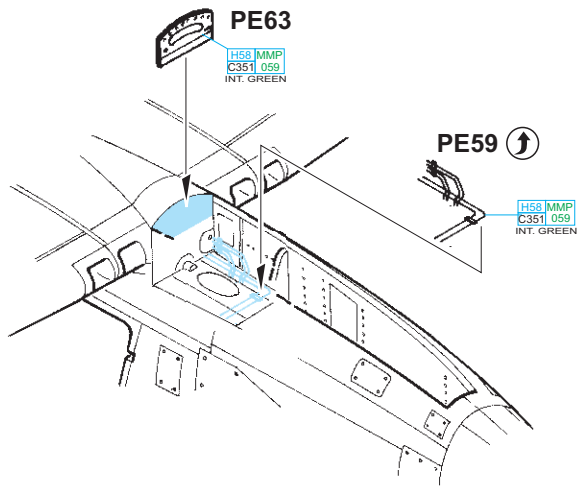

C1 ? C51 - MARKING A

C12 ? C60 - MARKINGS B-J

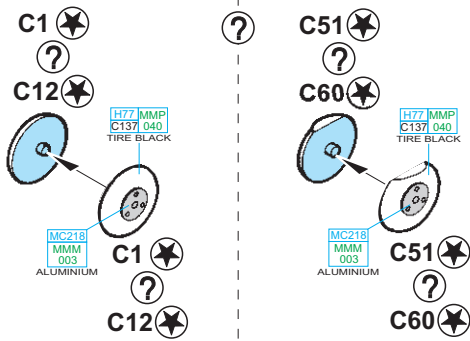

1 = H58 MMP C351 059 INT. GREEN - MARKINGS A-E, G-J
 H67 MMP C115 021 LIGHT BLUE - MARKING F

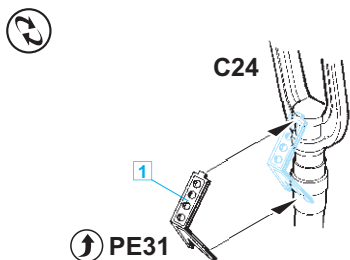
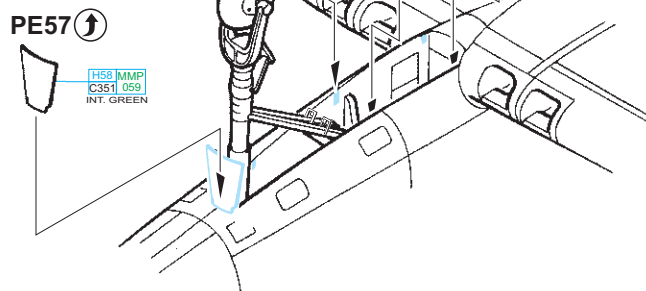
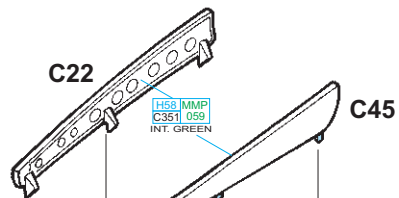
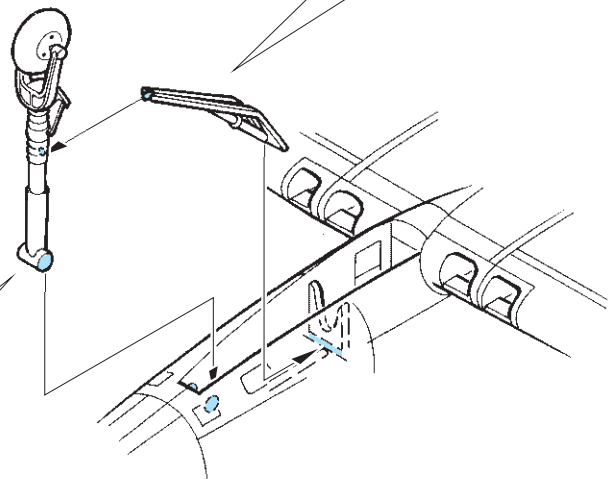
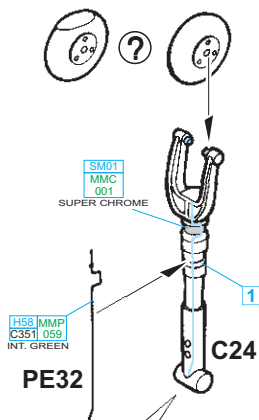

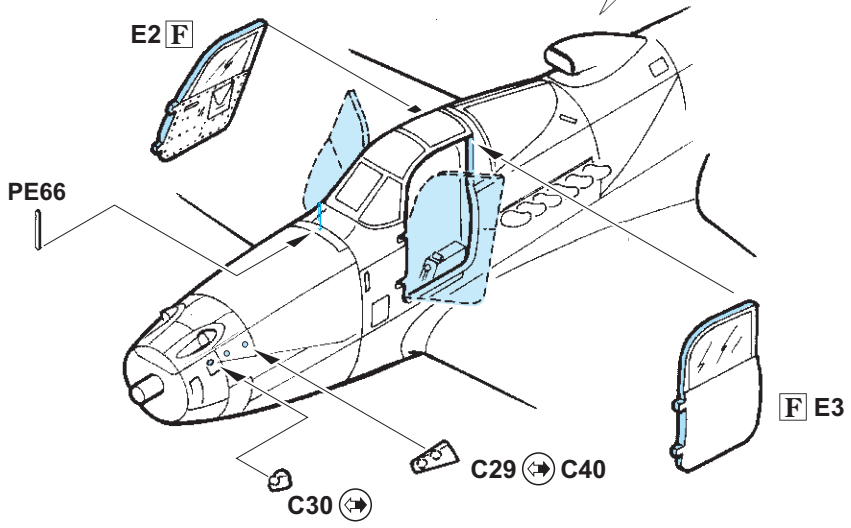
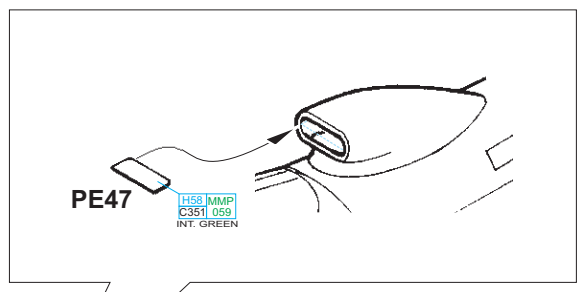
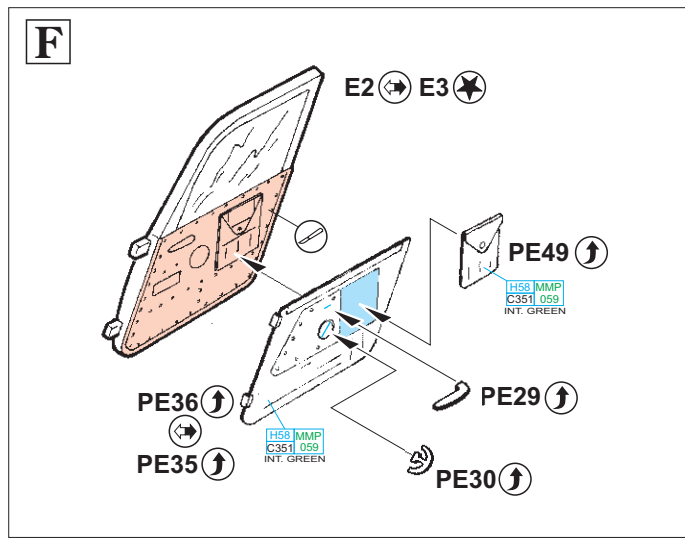
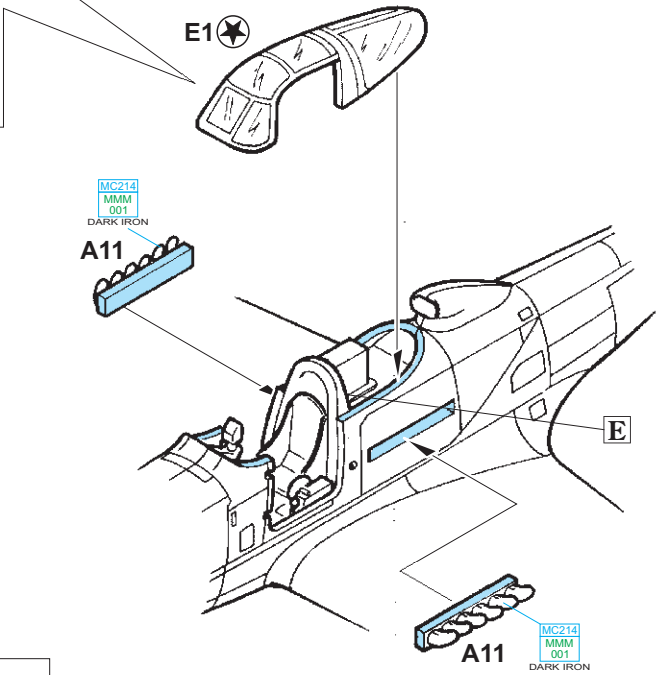
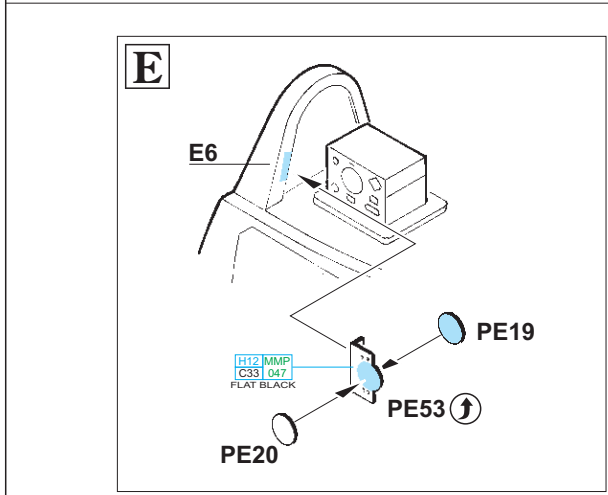
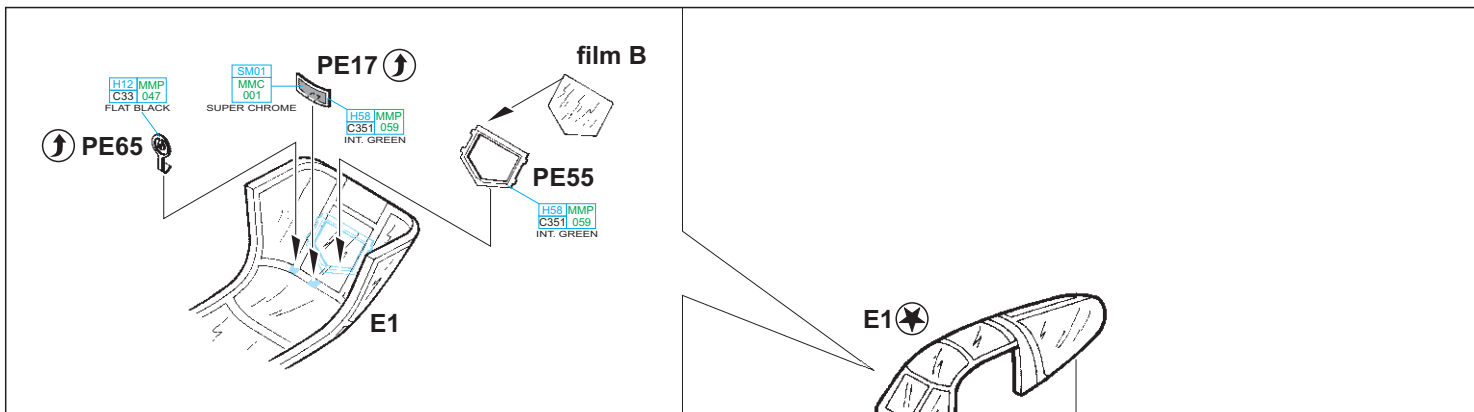

G

C36 - MARKING **A** ONLY

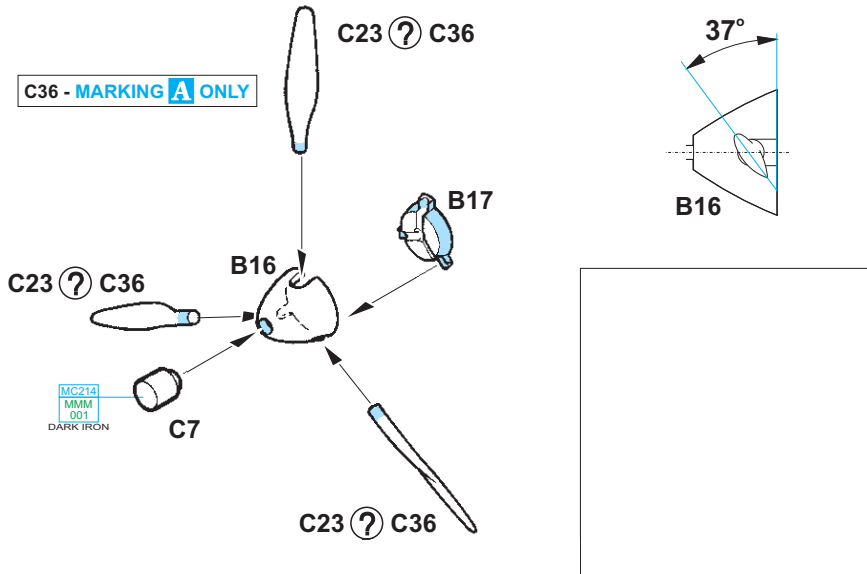

C20, C21 - MARKINGS **A-D** ONLY

C20, C21 - MARKINGS **A-D** ONLY

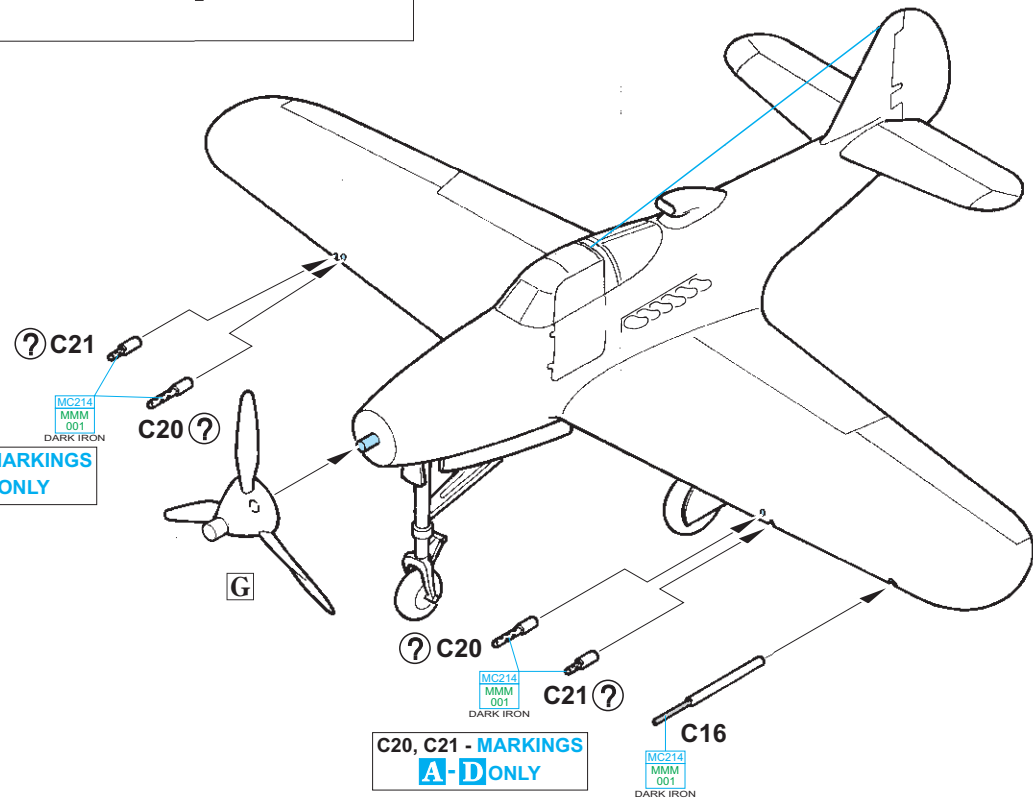

eduard
MASK

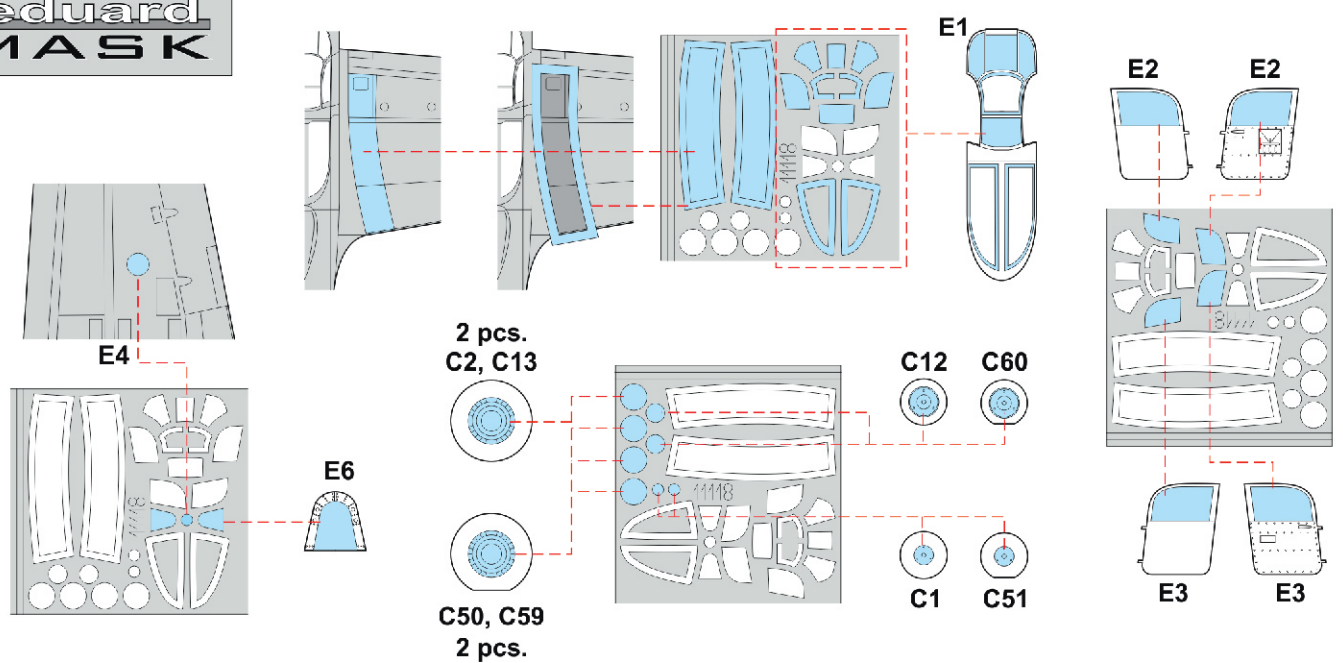

A P-39K-1, s/n 42-4480, 494. IAP, 303. IAD, Smolensk area, Autumn 1943

Photo shows that rudder has different, significantly brighter color than rest of the tail. It suggests an idea, that rudder could be replaced from the different plane and serial number on the tail could be the composited of the original 244xx and new xxx80. The arrow painted on the sides of the fuselage was a typical marking that identified aircraft of the 303. IAD. The original American insignia on the fuselage and the upper surfaces of the wings were oversprayed in AMT-4 Green and AMT-7 on the lower sides. Worth noting is the size of the stars, larger than the norm, and the borders in silver and red.

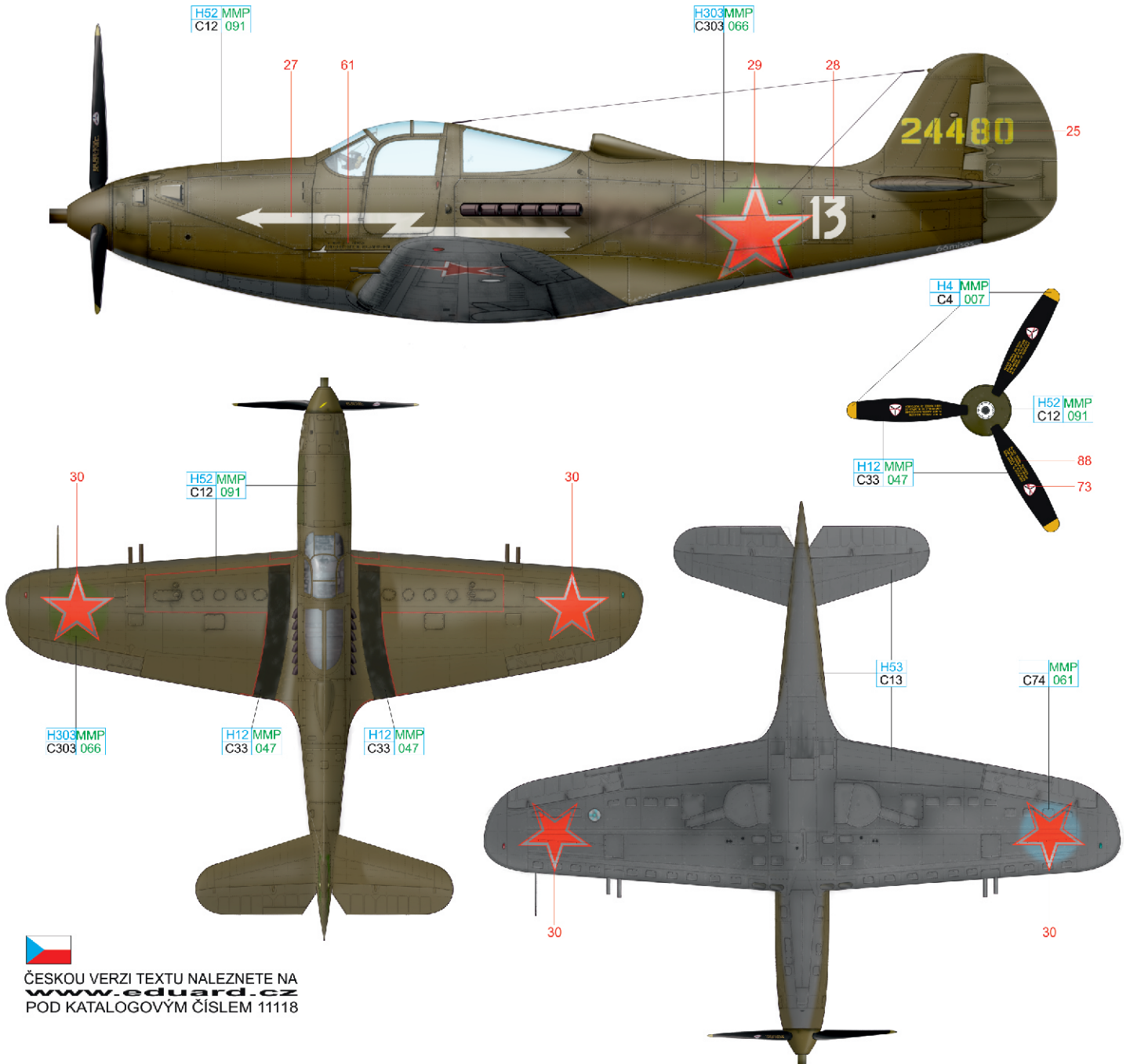

ČESKOU VERZI TEXTU NALEZNETE NA
www.eduard.cz
 POD KATALOGOVÝM ČÍSLEM 11118

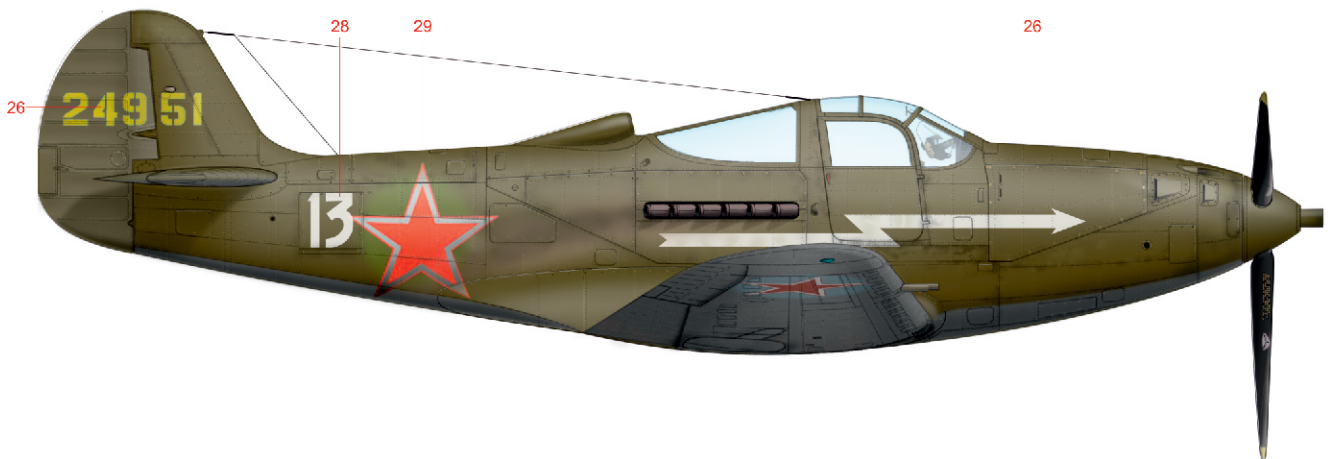

OLIVE DRAB	H52 MMP C12 091	AMT-4 GREEN	H303 MMP C303 066	NEUTRAL GRAY	H53 C13	AMT-7 BLUE	MMP C74 061	BLACK	H12 MMP C33 047	LIGHT YELLOW	H4 MMP C4 007
------------	-----------------	-------------	-------------------	--------------	---------	------------	-------------	-------	-----------------	--------------	---------------

eduard

B P-39N-0, s/n 42-8747, flown by Guard Captain Grigoriy Andreevich Rechkalov, 16. GIAP, Germany, Spring 1945

This is probably the best known Soviet Cobra which was flown by G. A. Rechkalov, double Hero of the Soviet Union and the pilot with the highest score achieved in P-39. However, this Cobra was also often photographed with A. I. Pokryshkin. That was the reason this Cobra was in the past by mistake identified as Pokryshkin's "Sotka" (one hundred). Another interesting fact related to this Cobra is that the serial number painted on the tail 42547 (e.g. 44-2547) is different from the original serial number 42-8747 painted in the factory beneath the left door. This suggests that rear fuselage or at least tail was replaced and repainted (AMT-4) after the damage caused by overload during wild flying maneuvers. The similar deformations have happened also on many others Cobras. G. A. Rechkalov achieved 61 individual and 4 group victories during WWII. These numbers include also 3 victories from 1941 that are not included in the official list. From the summer of 1943, the 16. GIAP used a red outlined in white top of the vertical tail and a red spinner as a quick identification aid.

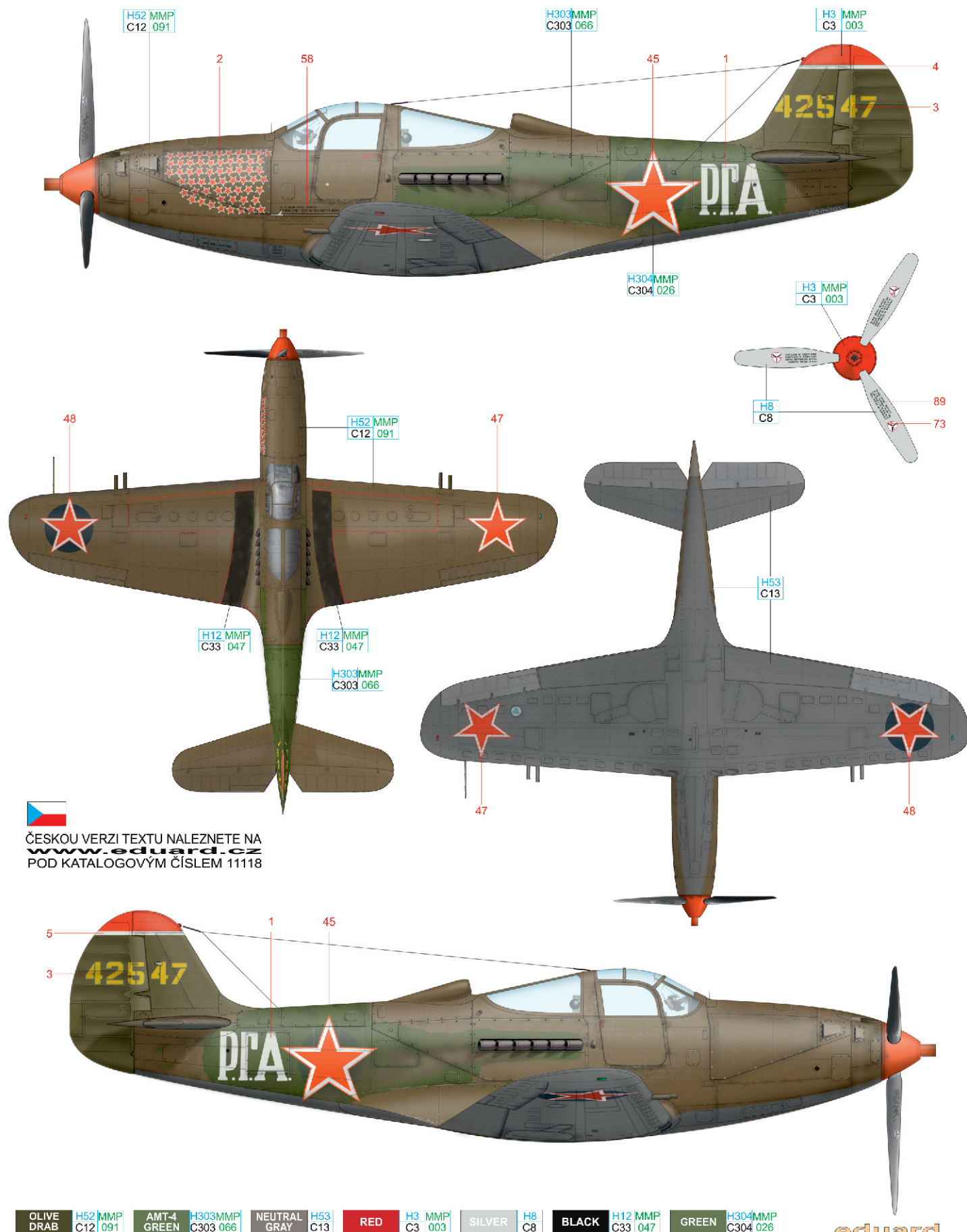

ČESKOU VERZI TEXTU NALEZNETE NA
www.eduard.cz
 POD KATALOGOVÝM ČÍSLEM 11118

OLIVE DRAB	H52 MMP C12 091	AMT-4 GREEN	H303 MMP C303 066	NEUTRAL GRAY	H53 C13	RED	H3 MMP C3 003	SILVER	H8 C8	BLACK	H12 MMP C33 047	GREEN	H304 MMP C304 026
------------	-----------------	-------------	-------------------	--------------	---------	-----	---------------	--------	-------	-------	-----------------	-------	-------------------

eduard

C P-39N-1, s/n 42-9434 , flown by Senior Lieutenant Alexandr Fedorovich Klubov, 16. GIAP, east Poland, August 1944

Alexandr Fedorovich Klubov came to the 16. GIAP at the end on May 1943. As a part of the 1st Squadron he mastered a new fighter "Aircobra" under the direction of A. Pokryshkin. In July 1943 after aerial combat his "Cobra" was so deformed by machine overload that it was not subject to the recovery. On April 13th, 1944 Senior Lieutenant Klubov was awarded title of Hero of the Soviet Union a for 14 individual and 19 shared victories. Next days and weeks a number of photo sessions took place, also together with Rechkalov. By August 25th, 1944 he achieved 31 individual and 19 group victories. Klubov tragically died on November 1st, 1944 when after landing his new La-7 fighter skidded off the airfield and nosed over. This was one of the reasons why Pokryshkin refused to replace P-39 by new La-7 in 16. GIAP, although he received his personal La-7. Guard Captain Alexander Fedorovich Klubov was posthumously awarded the second HSU on June 27th, 1945. The small stars signified kills, the red ones denoting individual victories and the white ones shared in which Klubov participated.

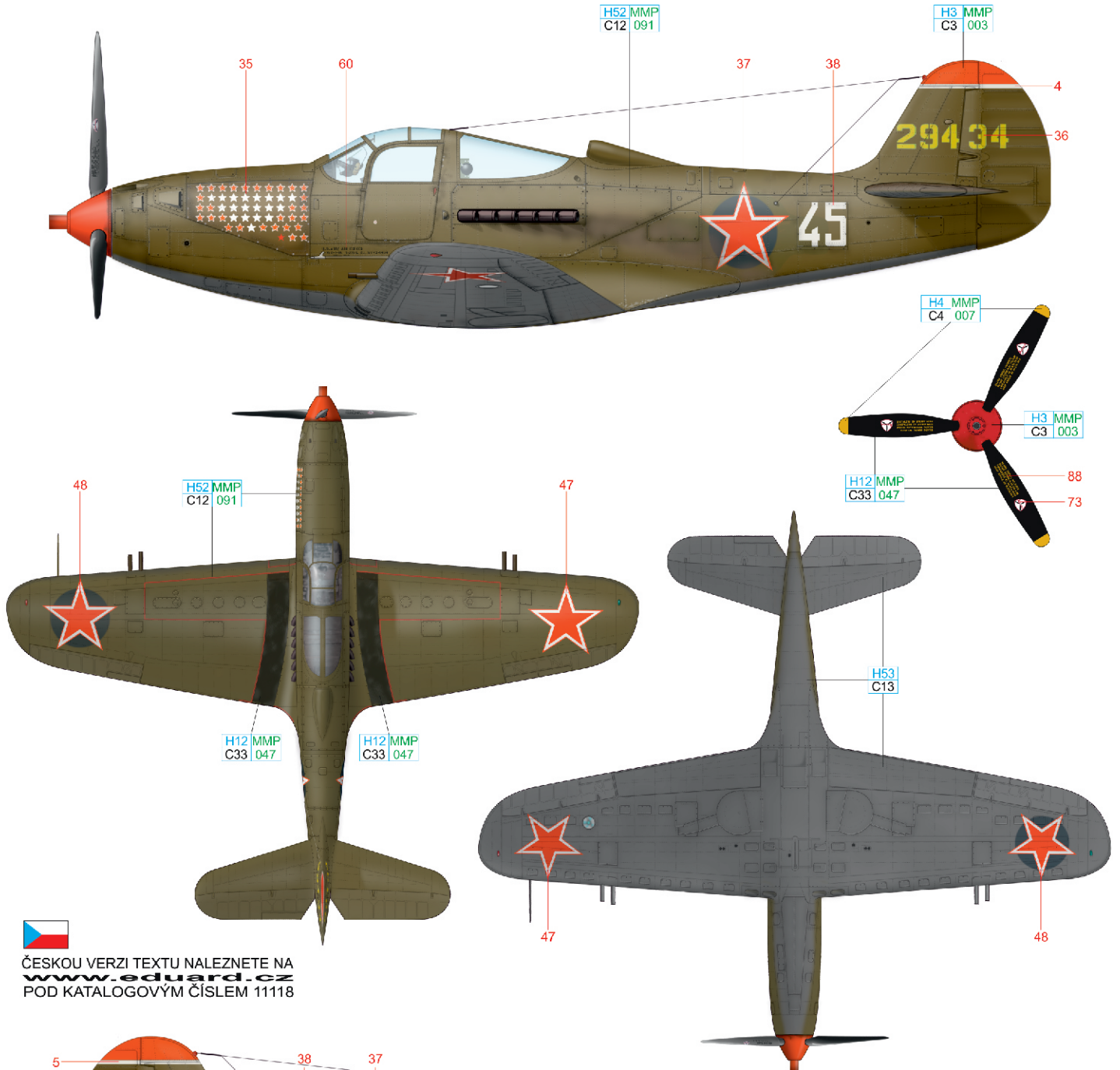

ČESKOU VERZI TEXTU NALEZNETE NA www.eduard.cz POD KATALOGOVÝM ČÍSLEM 11118

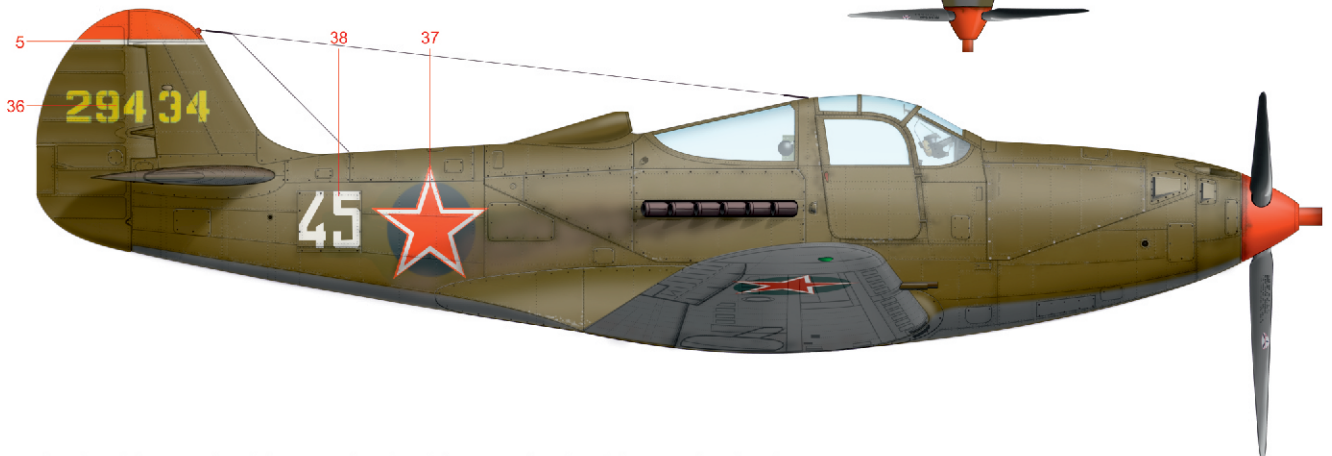

OLIVE DRAB H52 MMP C12 091 NEUTRAL GRAY H53 C13 RED H3 MMP C3 003 BLACK H12 MMP C33 047 LIGHT YELLOW H4 MMP C4 007

eduard

D P-39N-0, s/n 42-9004, flown by Guard Captain Alexandr Ivanovich Pokryshkin, 16. GIAP, Kuban, Soviet Union, May 1943

This plane is Pokryshkin's probably the best known but probably the least flown „Sotka“ („One hundred“). She was delivered to 16. GIAP on May 15th, 1943. Pokryshkin won his 30th victory a day before, on May 14th, 1943 at the different plane. A week latter, on May 24th, he was awarded the title of Hero of the Soviet Union. He was promoted to Guard Major in June 1943. Not even two months latter, in August 24th, A. I. Pokryshkin received his second title of HSU as a squadron leader in 16. GIAP. In the meantime, this plane was damaged at the airport by rolling Il-2 at the end of July or beginning of August 1943 and written off from 16. GIAP. After one year in August 19th, 1944 already as a commander of 16. GIAP in the rank of Guard Colonel he received his third HSU for 53 victories. He was the first person in Soviet Union that received 3 HSU and the only person who received it during the war (Zukhov received his 3rd HSU in June 1st, 1945, and Kozhedub received his 3rd HSU in August 18th, 1945). A. I. Pokryshkin finished the war as a Commander of the 9. GIAD with 53 individual and 6 group victories (different sources give different numbers). American national markings were likely oversprayed with a fresh coat of American Olive Drab and Neutral Grey paint prior to delivery to the USSR.

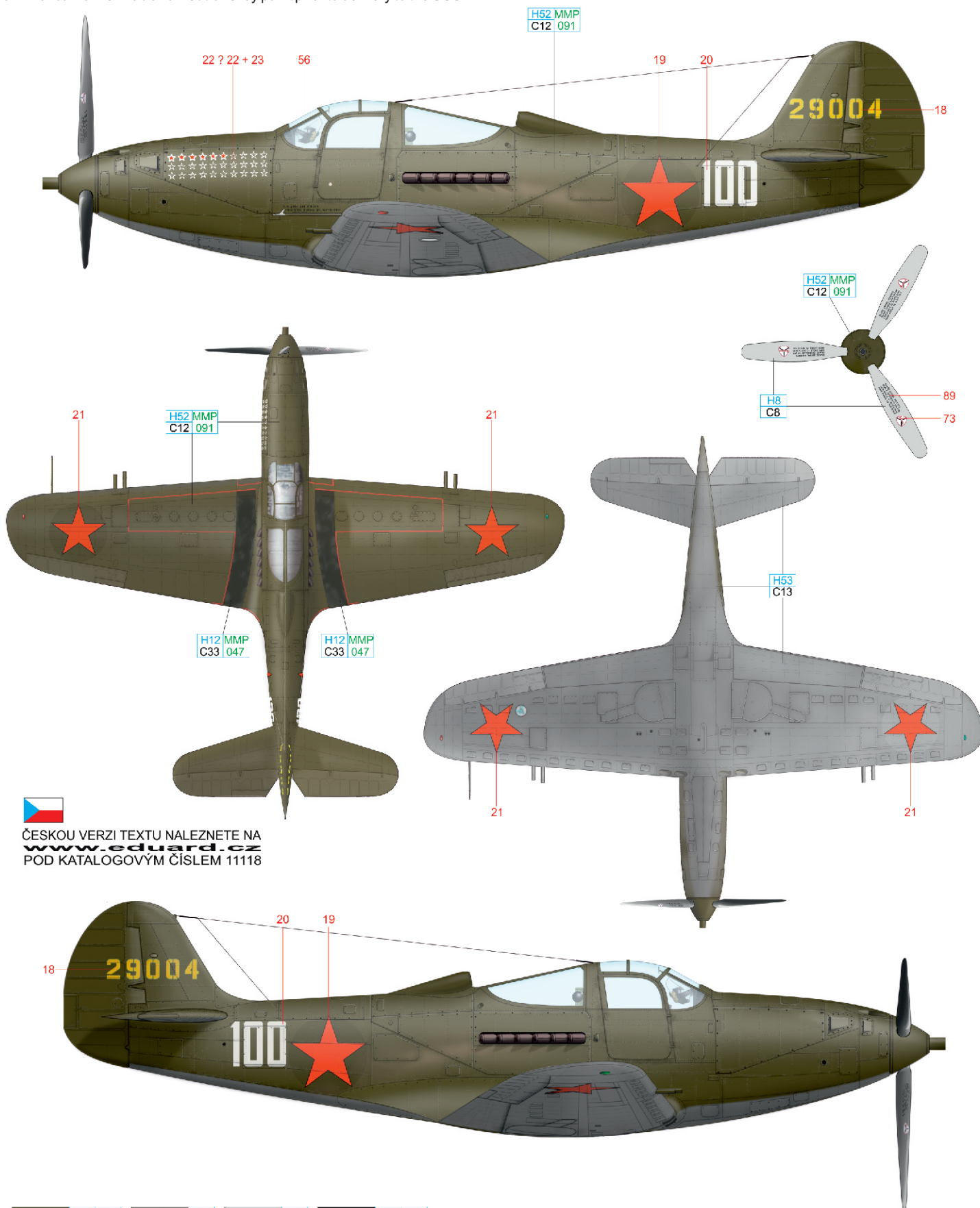

ČESKOU VERZI TEXTU NALEZNETE NA www.eduard.cz POD KATALOGOVÝM ČÍSLEM 11118

OLIVE DRAB H52 MMP C12 091 NEUTRAL GRAY H53 C13 SILVER H8 C8 BLACK H12 MMP C33 047

eduard

E P-39Q, flown by Guard Senior Lieutenant Konstantin Vasilievich Sukhov, 16. GIAP, Aslau, Germany, March 1945

This Cobra was flown by K. V. Sukhov, a Hero of the Soviet Union. However, this Cobra is well known from the bombing tests performed in March 1945 by A. I. Pokryshkin in the cockpit. That time the 16. GIAP was based at the Aslau airfield and used the nearby section of the Berlin - Breslau highway as a runway. Aslau was the operational airfield with the the factory producing Fw-190A and D until January 1945. So when Sukhov's Cobra was damaged in February 1945 it is very probable that former German facility and paints were used for repair. K. V. Sukhov achieved 22 individual victories during WWII. From the summer of 1943 the red outlined in white fin tip and red spinner were quick identifiers used by the 16. GIAP. The original American camouflage of the Airacobras were probably supplemented on Suchov's aircraft in Aslau with RLM82 on the upper surfaces and partially on the panels of the lower surfaces in RLM76.

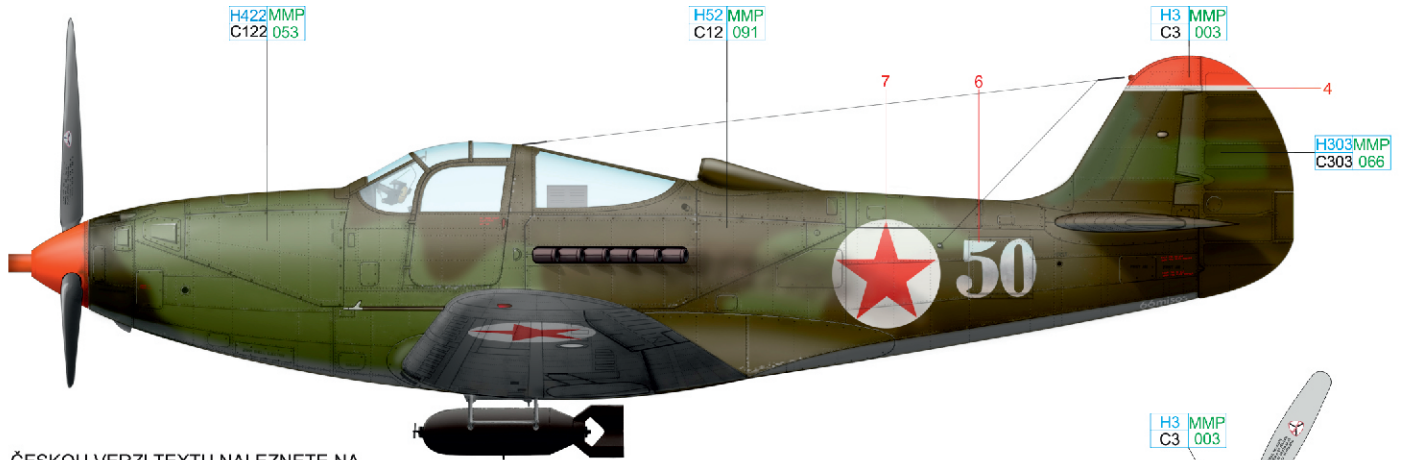

ČESKOU VERZI TEXTU NALEZNETE NA www.eduard.cz POD KATALOGOVÝM ČÍSLEM 11118

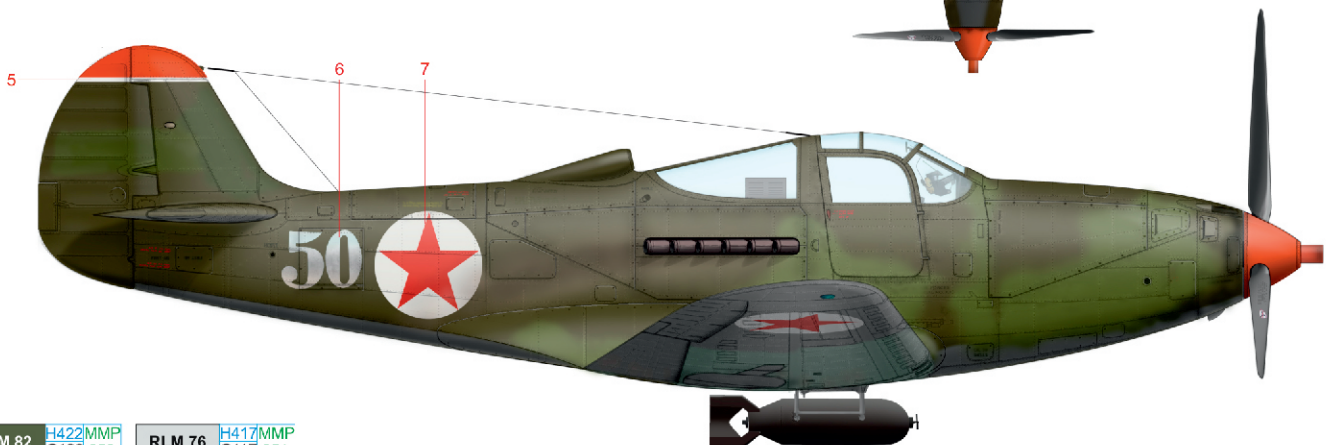
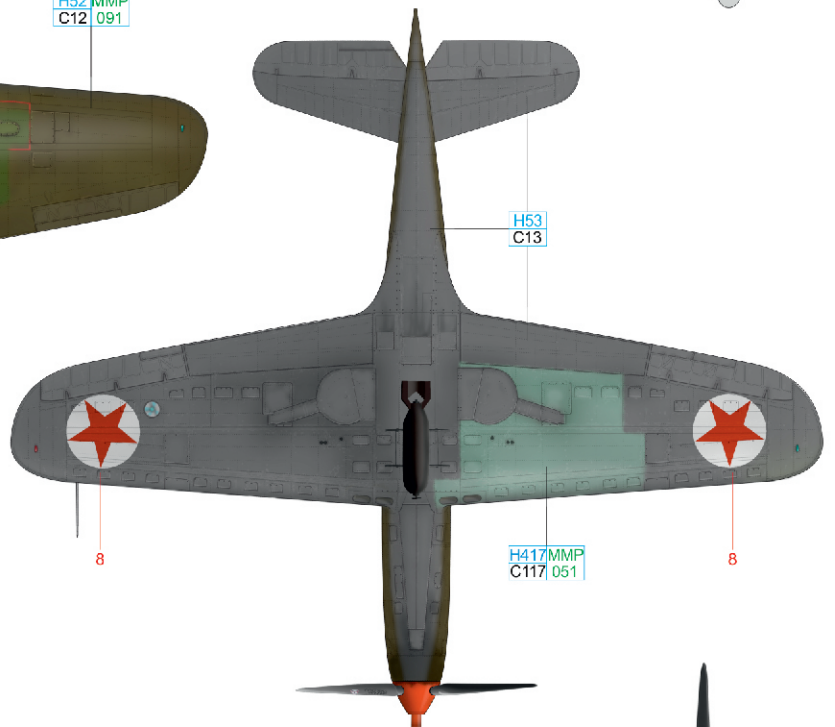
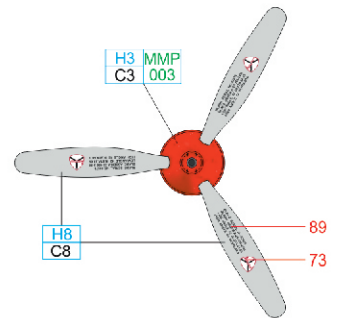

RLM 82	H422MMP C122 053	RLM 76	H417MMP C117 051
OLIVE DRAB	H52 MMP C12 091	AMT-4 GREEN	H303MMP C303 066
		NEUTRAL GRAY	H53 C13
		RED	H3 MMP C3 003
		SILVER	H8 C8
		BLACK	H12 MMP C33 047

F P-39Q-10, 212. GIAP, 22. GIAD, Stockerau, Austria, 1946

This Airacobra from 212. GIAP is in the non-standard one-color light blue-gray scheme, photographed sometime between summer 1945 and winter 1946/47 when regiment was based at the Stockerau airfield in Austria. Note missing Alexander Nevsky and Guard emblem on the door. A blue nose, including the prop spinner, served as a quick identification aid on aircraft of the 212. GIAP at the end of the Second World War. A diagonal band in the vertical tail in yellow identified aircraft of the 22. GIAD. Some sources claim that this band may have been blue or white.

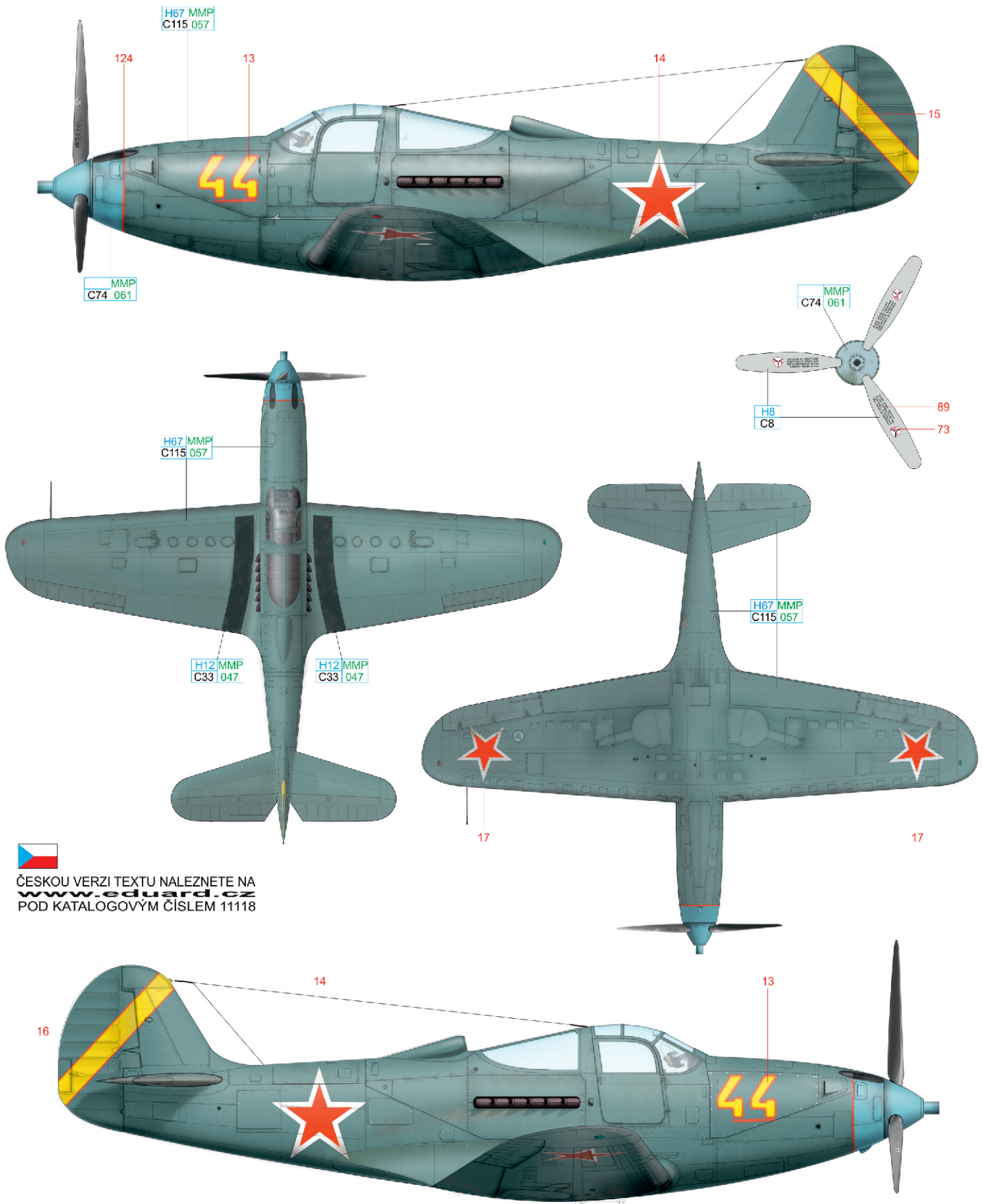

ČESKOU VERZI TEXTU NALEZNETE NA
www.eduard.cz
 POD KATALOGOVÝM ČÍSLEM 11118

GRAY	H67 MMP C115 057	AMT-7 BLUE	MMP C74 061	SILVER	H8 C8	BLACK	H12 MMP C33 047
------	---------------------	---------------	----------------	--------	----------	-------	--------------------

eduard

G P-39Q-15, s/n 44-2567, 68. GIAP, 5. GIAD, 1. Baltic Front, winter 1944 – 1945

P-39s from American stocks under the Lend-Lease agreement were supplied in the standard colours used by the United States Army Air Force - upper surfaces in Olive Drab, while the bottom surfaces were in Neutral Grey. Aircraft of the 68. GIAP were adorned with a blue band with a white outline on the rear fuselage and a blue spinner, these serving as a quick IFF aid. This aircraft also had the mass balance and cannon muzzle cover in the spinner in white. The original American national insignia were oversprayed in AMT-4 Green on the fuselage and upper wings and in AMT-7 on the lower wings.



ČESKOU VERZI TEXTU NALEZNETE NA www.eduard.cz POD KATALOGOVÝM ČÍSLEM 11118

OLIVE DRAB H52 MMP C12 091 AMT-4 GREEN H303 MMP C303 066 NEUTRAL GRAY H53 C13 AMT-7 BLUE MMP C74 061 SILVER H8 C8 BLACK H12 MMP C33 047 WHITE H11 MMP C62 001

eduard

H P-39Q-15, 213. GIAP, Germany, spring 1945

213. GIAP participated in Prague Operation in May 1945. Cobras from 213. GIAP had Alexander Nevsky emblem on the left door while Guard emblem on the right door. Blotched of probably light brown color do not fit to any standard camouflage scheme used by Soviet fighter planes. Most probably it is either repair and repaint with the individual „creativity“. The standard American camouflage consisting of Olive Drab and Neutral Grey were supplemented with A-21m Light Brown on the upper and side surfaces. The American national insignia was oversprayed on the fuselage and upper wings with AMT-4 green and AMT-7 on the lower wings.

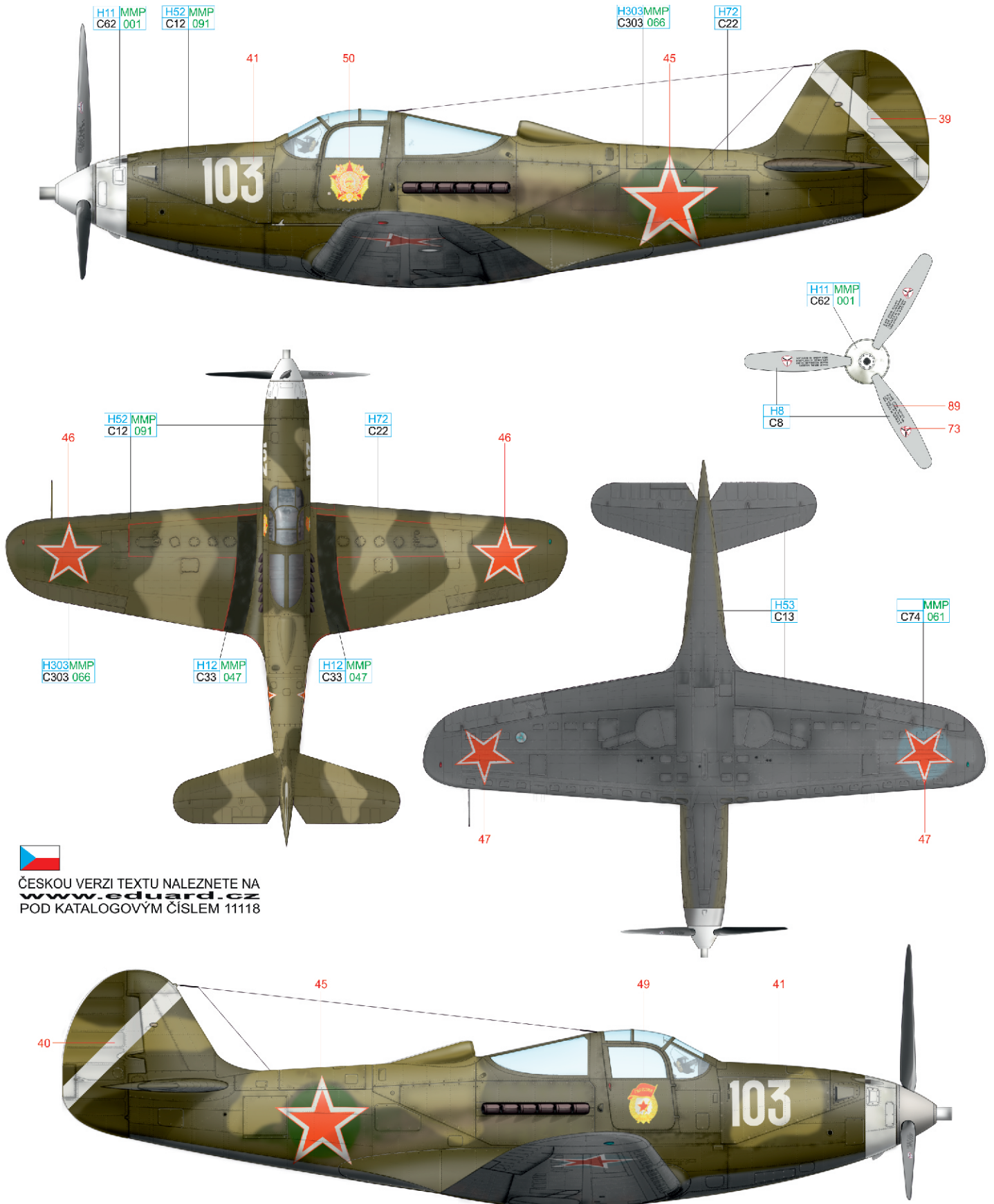

ČESKOU VERZI TEXTU NALEZNETE NA
www.eduard.cz
 POD KATALOGOVÝM ČÍSLEM 11118

SILVER	H8 C8	BLACK	H12 MMP C33 047	WHITE	H11 MMP C62 001
OLIVE DRAB	H52 MMP C12 091	AMT-4 GREEN	H303MMP C303 066	A-21m BROWN	H72 C22
NEUTRAL GRAY	H53 C13	AMT-7 BLUE	MMP C74 061		

P-39Q, flown by Guard Major Anatoliy Leonidovich Kozhevnikov, 212. GIAP, 22. GIAD, Dabern, Germany, May/ June 1945

Anatoliy Leonidovich Kozhevnikov was Commander of 438. IAP for a short two-weeks period till August 23rd, 1944. By the end of WWII in the rank of Guard Major and as a Deputy Commander of the 212. GIAP, he achieved 25 individual victories (different sources give also 23 or 24 confirmed victories). He was awarded title of Hero of Soviet Union after the WWII on June 27th, 1945. 438. IAP was renamed to 212. GIAP in November 1944 and in April 5th, 1945 the 212. GIAP received an award of Alexander Nevsky Order. From May 9th to June 26th, 1945 the regiment was based at the Dabern airfield near Cottbus in Germany, where according to Kozhevnikov's memories "Every plane was checked. Soldiers-artists lovingly painted regimental order emblems on the fuselages." A. L. Kozhevnikov finished the war with 25 individual and 2 group victories. He was awarded the title of Hero of the Soviet Union after the war in June 27th, 1945. Kozhevnikov's aircraft was painted overall grey, probably A-32m, for the celebrations at the end of the war for victory parades and displays.

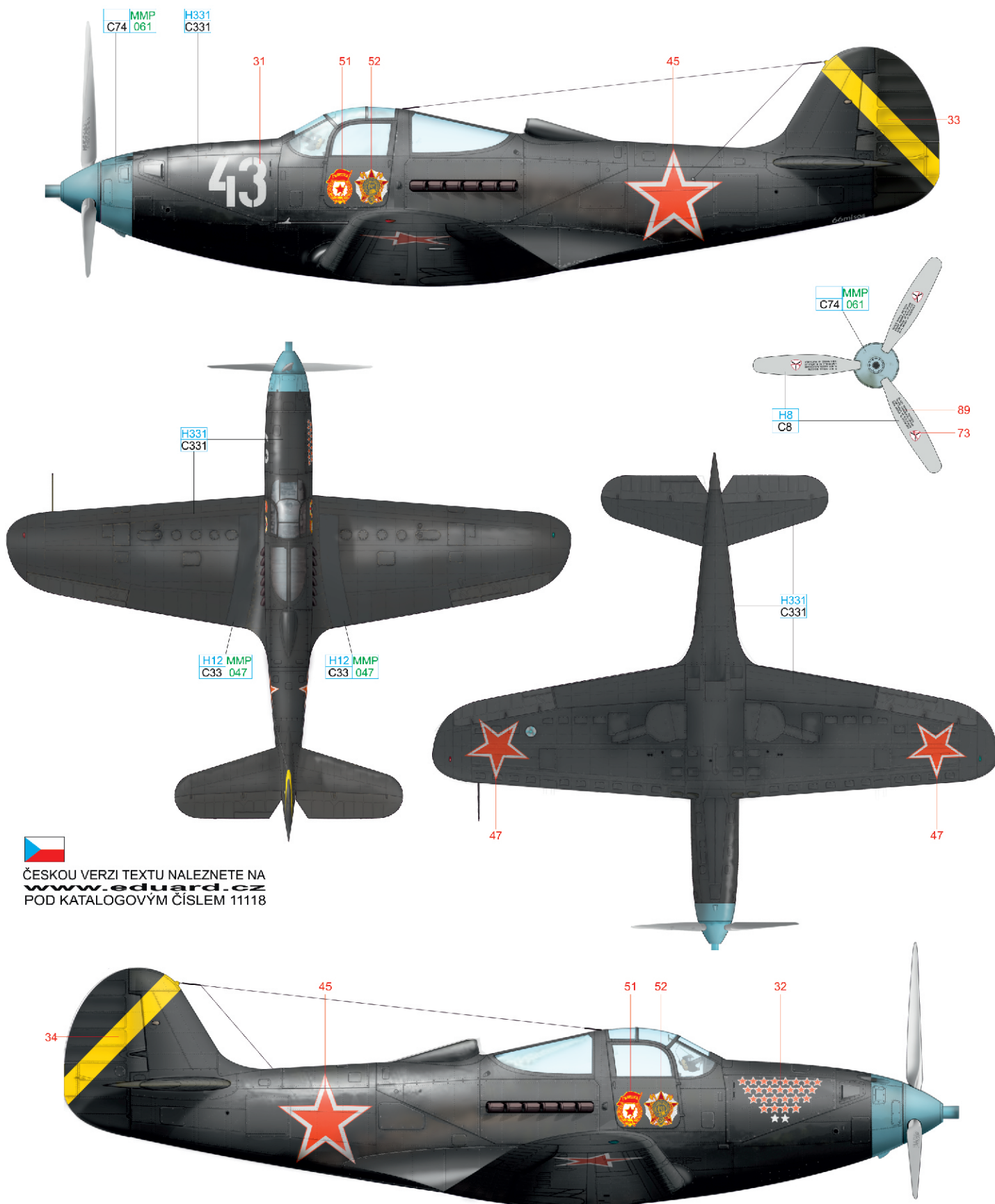

ČESKOU VERZI TEXTU NALEZNETE NA www.eduard.cz POD KATALOGOVÝM ČÍSLEM 11118

J P-39Q-30, s/n 44-71147, 213. GIAP, 22. GIAD, Germany, spring 1945

213. GIAP participated in Prague Operation in May 1945. Cobras from 213. GIAP had Alexander Nevsky emblem on the left door while Guard emblem on the right door. The white nose, including the spinner, served as a quick identification aid on aircraft of the 213. GIAP at the end of the Second World War. A diagonal band in the vertical tail in white identified aircraft of the 22. GIAD. Some sources claim that this band may have been blue or yellow. The American national insignia was oversprayed on the fuselage and upper wings with AMT-4 green and AMT-7 on the lower wings.

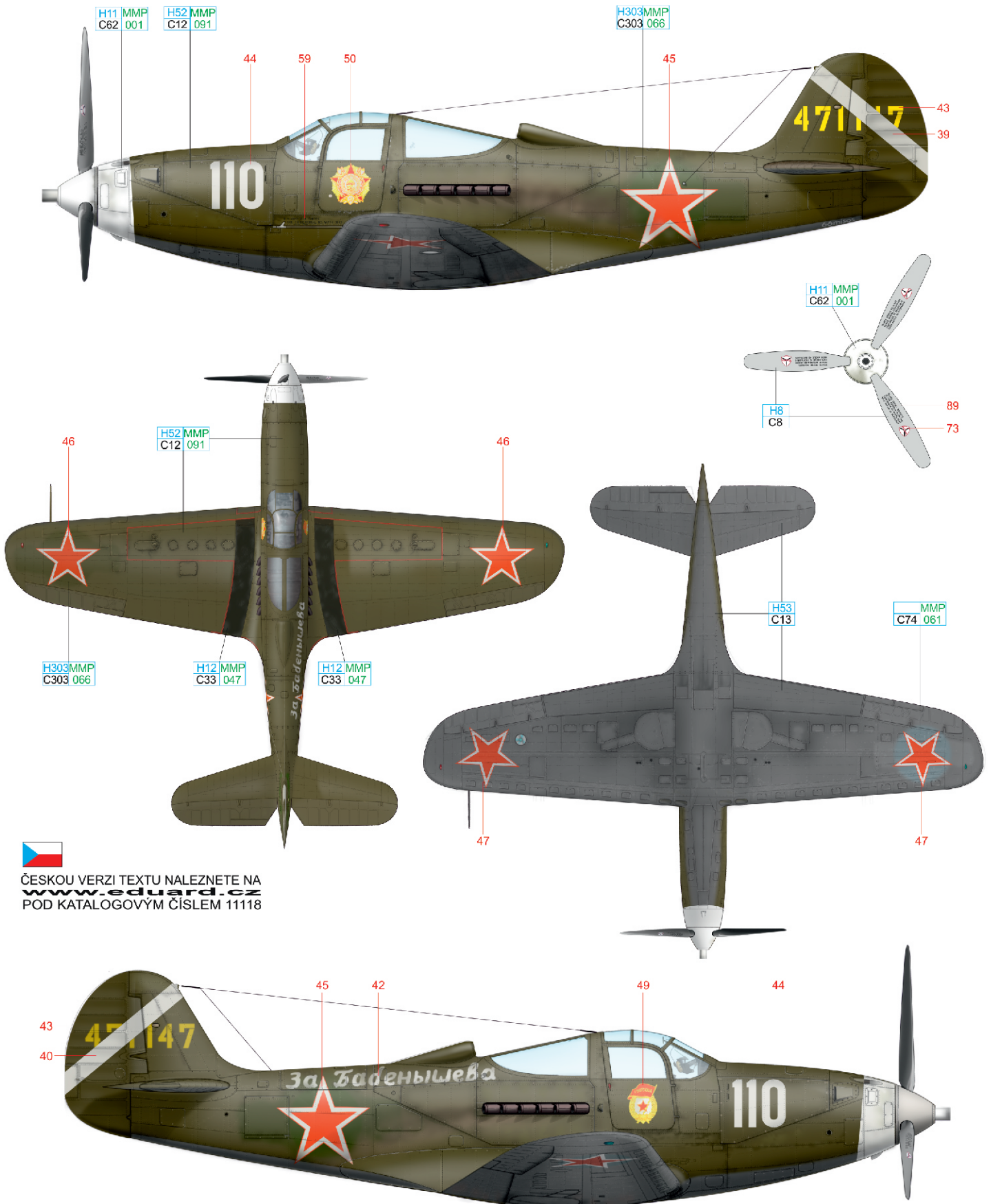

ČESKOU VERZI TEXTU NALEZNETE NA www.eduard.cz POD KATALOGOVÝM ČÍSLEM 11118

BLACK	H12 MMP C33 047	WHITE	H11 MMP C62 001
OLIVE DRAB	H52 MMP C12 091	AMT-4 GREEN	H303 MMP C303 066
		NEUTRAL GRAY	H53 C13
		AMT-7 BLUE	MMP C74 061
		SILVER	H8 C8

