

1:48 Scale

ITEM NO.:81749

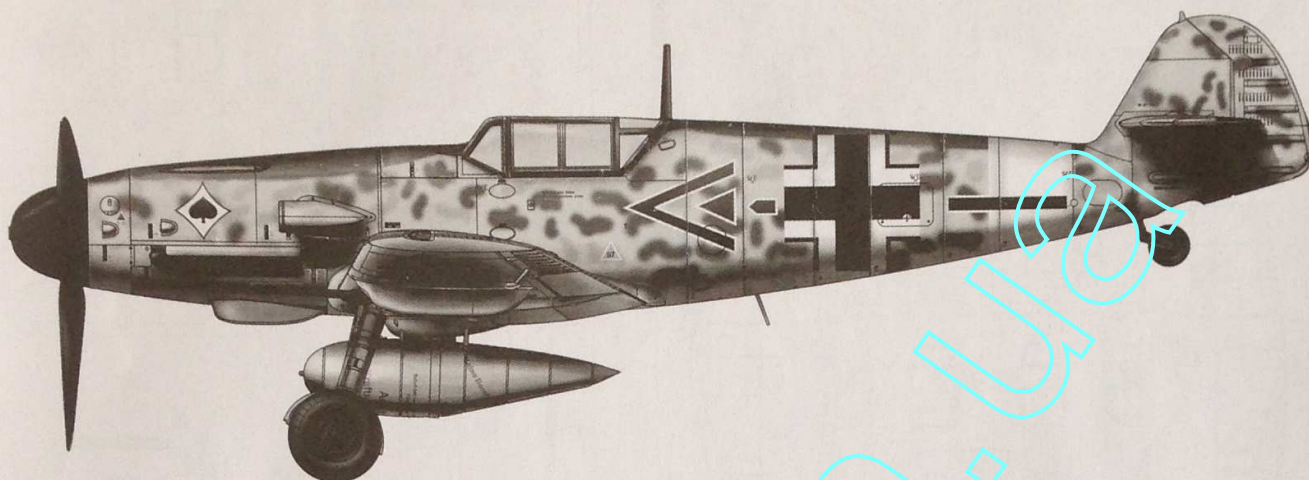

Bf109F-4

メッサーシュミット Bf109F-4 德国Bf109F-4战斗机

PLEASE READ BEFORE OPERATION!

- * Tools recommended as below: (Not included)
Adhesives; Paints; Side Cutters; Sharp Edged Pliers; Modeling Knife; Modeling File; Nippers; Drill; Scissors; Sand Paper; Soft Cloth; Cyanoacrylate Glue.
- * Make sure to read this instruction listed below before assembling.
- * The kit contains the small parts, they can be dangerous if swallowed by mistake, so keep them away from reach of children.
- * Cut the all parts off carefully and remove the waste parts into the garbage can.
- * More caution and care should be needed for cutting and handling the photo etched parts.
- * Make attention that some parts should be attached the decal when assembled.
- * During assembling, please tear up and throw away the plastic bags, or may cause the dangerous if wearing over head by children's mistake.
- * When using the adhesives and paints, please do not use them in the closed room or near the fire, also must be very careful to protect your eyes, face and clothes.
- * Adult supervised when assembled by children under 14 years old.

装配前请仔细阅读:

- * 推荐使用的模型工具(请自备):
专用模型胶水, 专用模型油漆, 水口剪刀, 长咀钳, 刀片, 锉刀, 镊子钳, 钻, 剪刀, 软布, 砂纸, 瞬间快干胶等。
- * 用水口剪刀或刀片小心切下所有塑胶零件和蚀刻片零件, 不要遗失小零件。
- * 切取蚀刻片时应特别注意防止利边划伤手指。
- * 用模型锉刀小心锉平所有零件表面的注射浇口。
- * 用适量的强力快干胶水粘合蚀刻片零件和金属轴, 切忌过量, 否则可能导致可动零件被粘住。
- * 注意某些零件表面需在装配时同步贴上水贴纸。
- * 制作时应远离幼儿并将包装袋及时收妥, 谨防小孩玩耍而引起意外。



cyanoacrylate glue
强力胶



weight
配重



make hole
钻孔



cut / remove
切除



option
选择



no cement
不涂胶水



decal
贴纸



bend
弯曲



repair
填补

The method to apply the decals

1. Cut off the decal from the decal paper and put it into the warm water 40°C for 10 seconds.
2. Take the decal from the water and put it on a piece of clean cloth.
3. Remove the decal slowly from the paper to the targeted location by a wet finger.
4. Use a piece of dry and soft cloth to press it gently on the decal until it getting dry and no bubble existing.

水贴纸的使用方法:

- 一. 把相关的印花从水贴纸上剪下, 放入40°C左右的温水中浸10秒。
- 二. 然后将印花放在干净的布上。
- 三. 拿上印花纸板, 手指蘸水将印花移到适当的位置。
- 四. 用软干布轻压印花直至水干, 气泡消失。

部品图
Parts

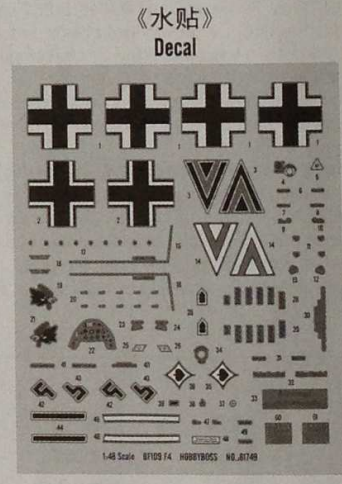
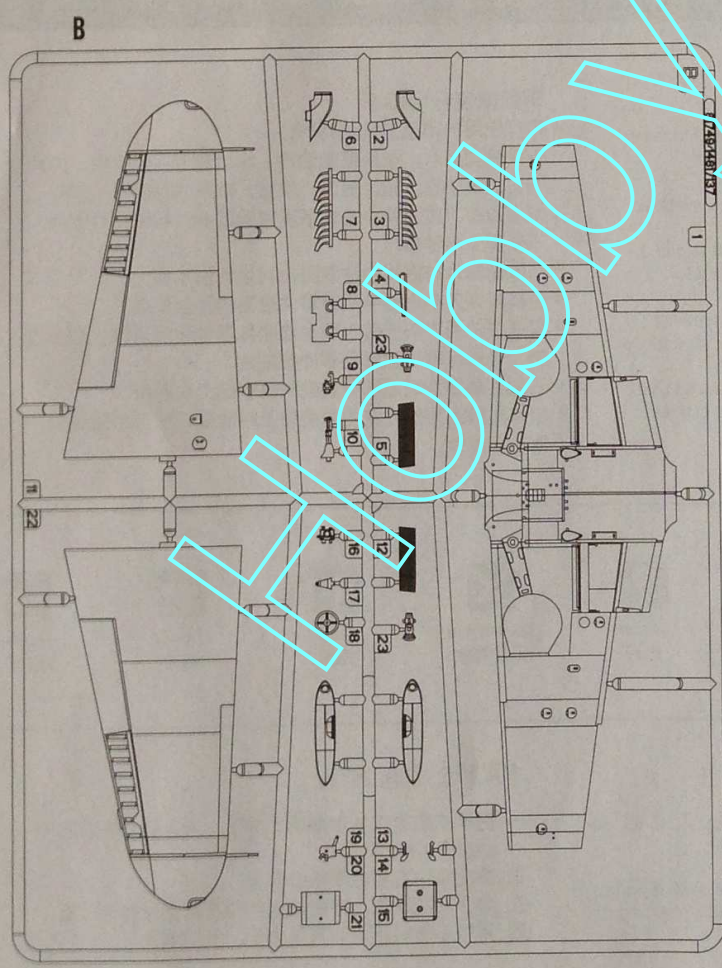
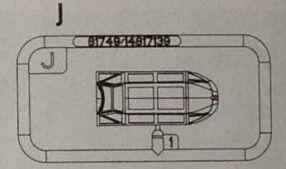
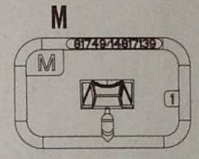
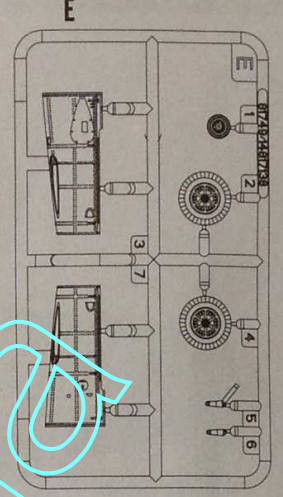
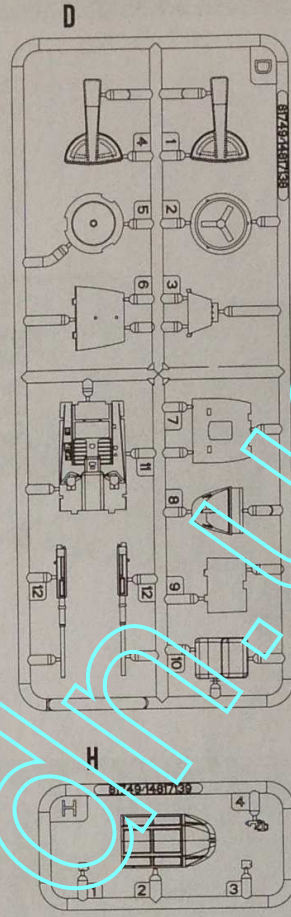
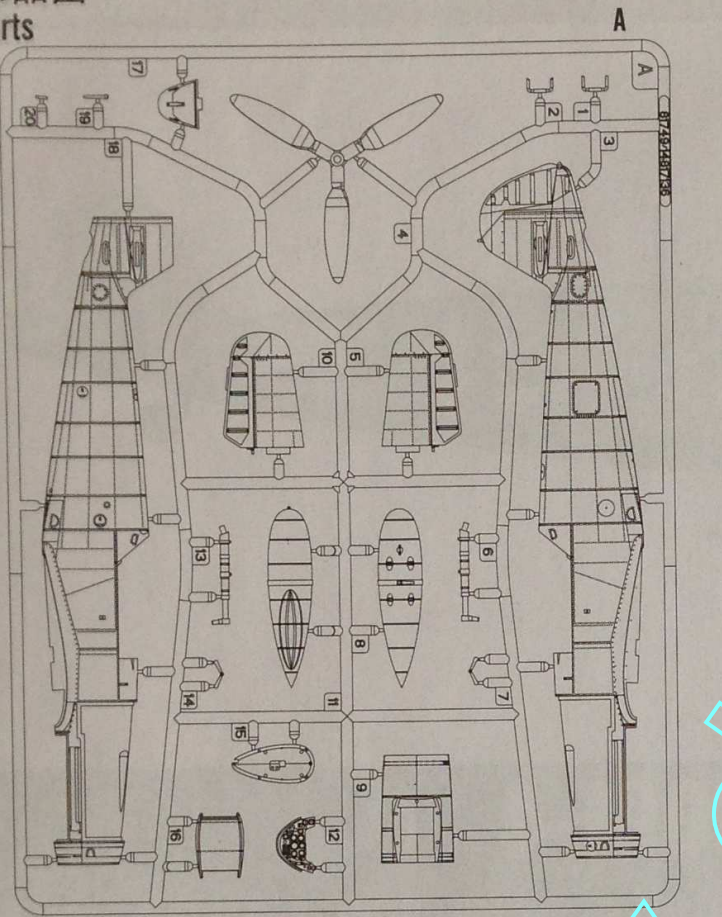

不用的部件: A17、B8、B9、H1、H3
Unused parts

1
STEP

《座舱》
Cockpit

H 116
黑灰色
RLM66 Black Gray

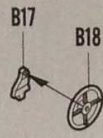
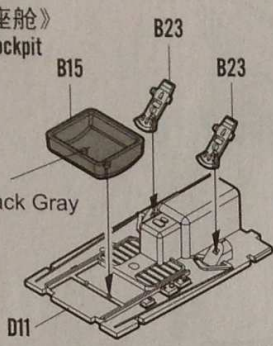

D6

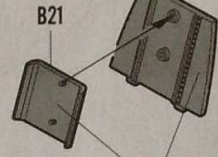

H 116
黑灰色
RLM66 Black Gray

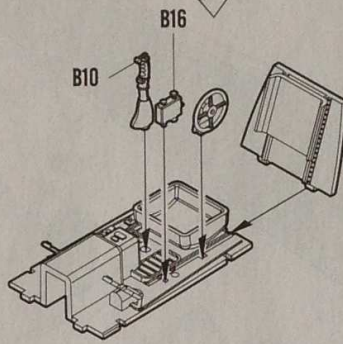

Decal
贴纸
(22)

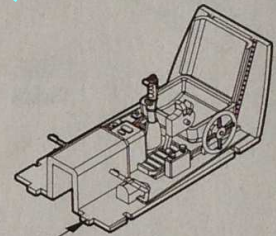
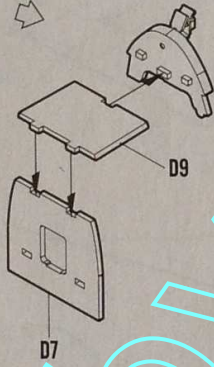
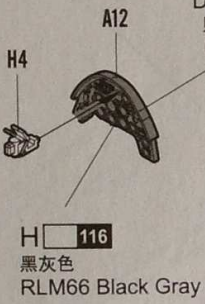

2
STEP

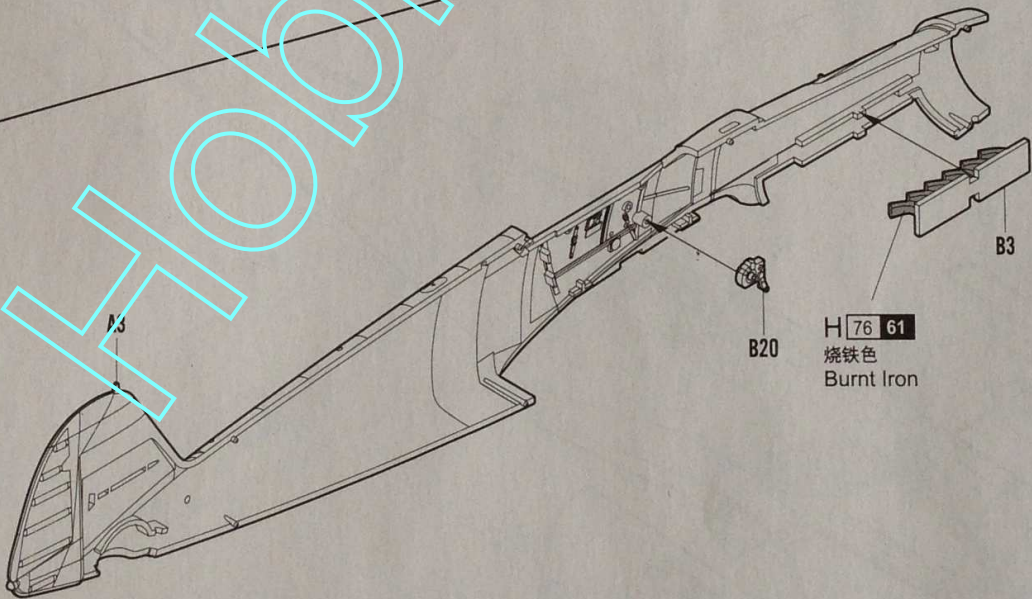

H 76 61
烧铁色
Burnt Iron

B20

B3

3
STEP

H 70 60
德国灰
RLM02 Gray

A18

D8

H 116
黑灰色
RLM66 Black Gray

B7

《座舱》
Cockpit

对侧 A10
Opposite A10
A5

4
STEP

E7

E3

5
STEP

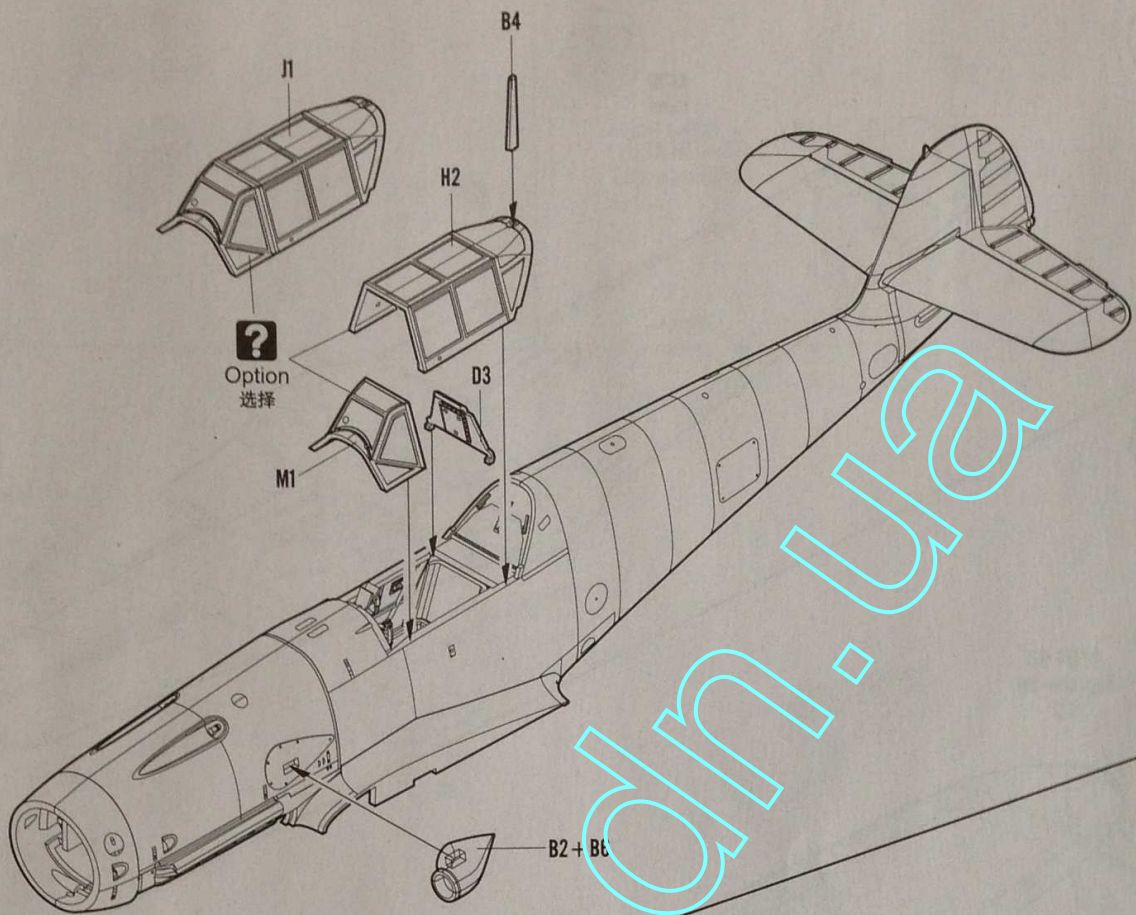

6
STEP

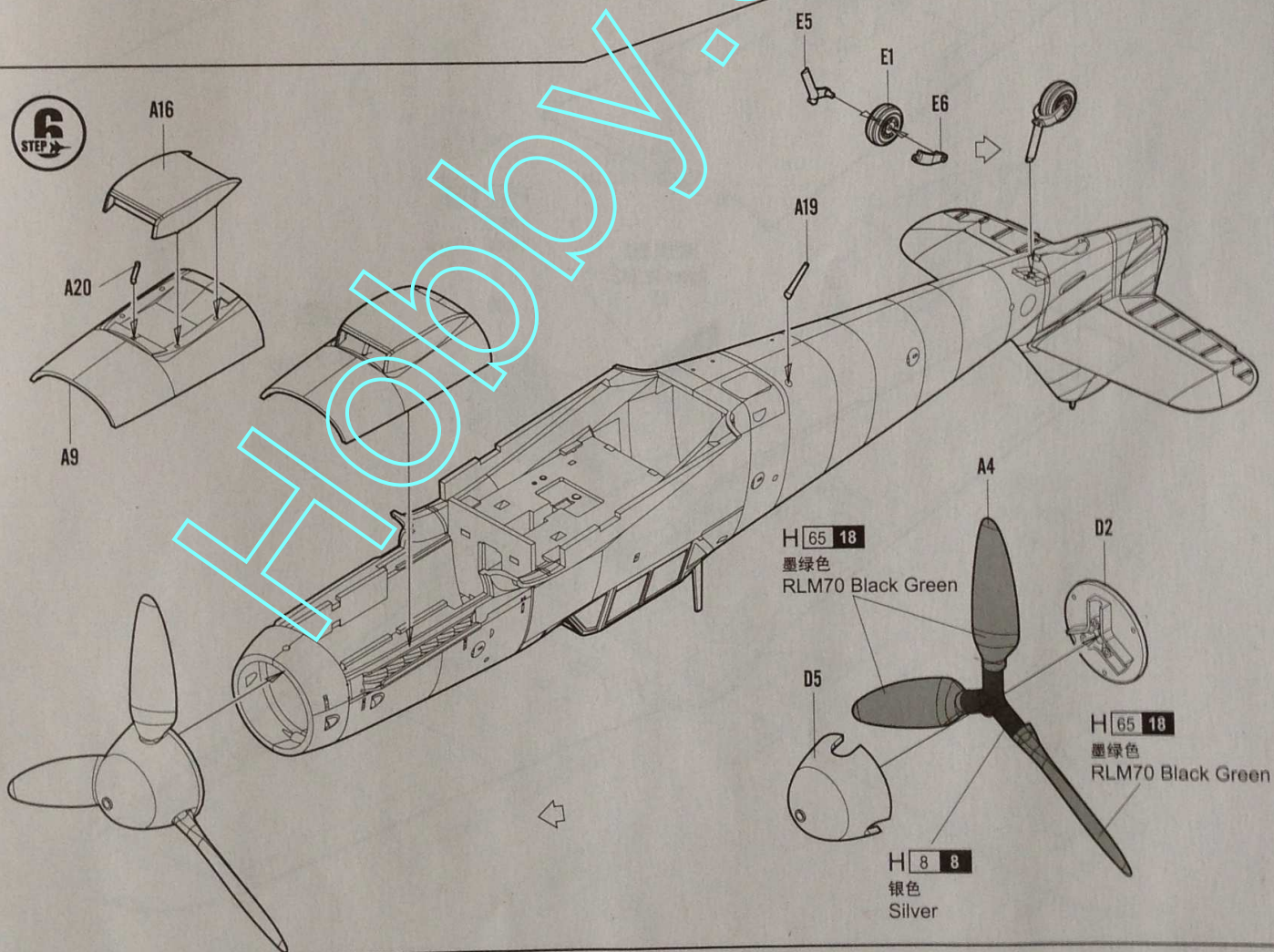

7
STEP

B1

Make holes
钻孔

Make holes
钻孔

8
STEP

对侧 B11
Opposite B11
B22

对侧 B12
Opposite B12
B5

H 18 28
黑铁色
Metal Black

D10
H 70 60
德国灰
RLM02 Gray

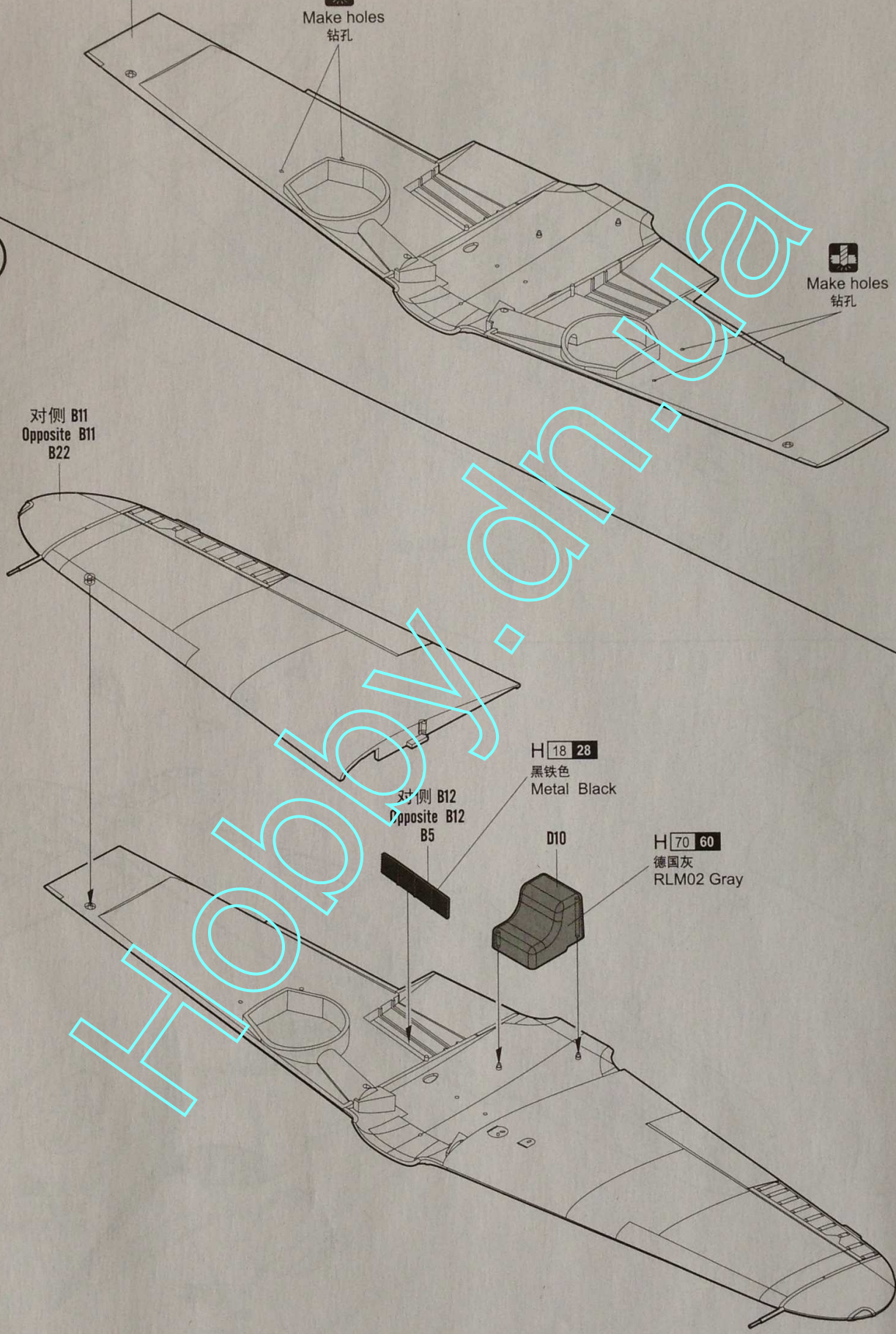

9
STEP

H 70 60

德国灰
RLM02 Gray

《右侧起落架》
Right undercarriage

H 77 137

胎黑色
Tire Black

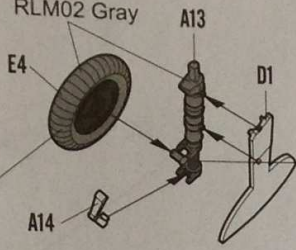

H 8 8

银色
Silver

10
STEP

《左侧起落架》
Left undercarriage

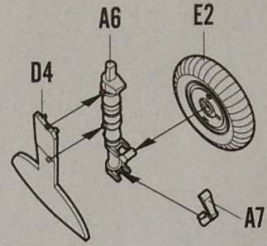

11
STEP

H 18 28

黑铁色
Metal Black

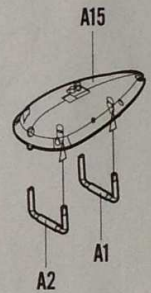
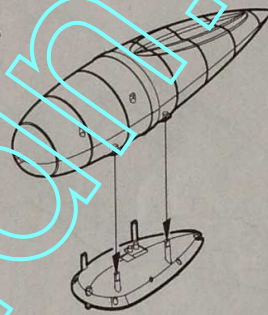
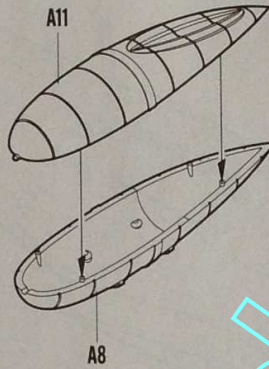
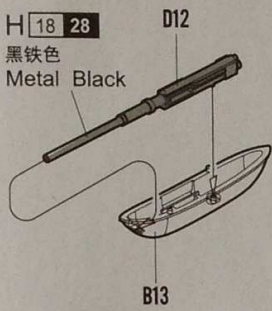

《左侧起落架》
Left undercarriage

《右侧起落架》
Right undercarriage

对侧相同
Both sides

B14

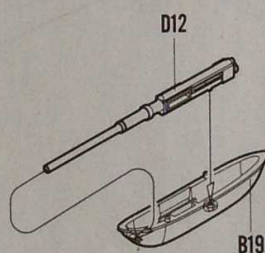

B19

12
STEP

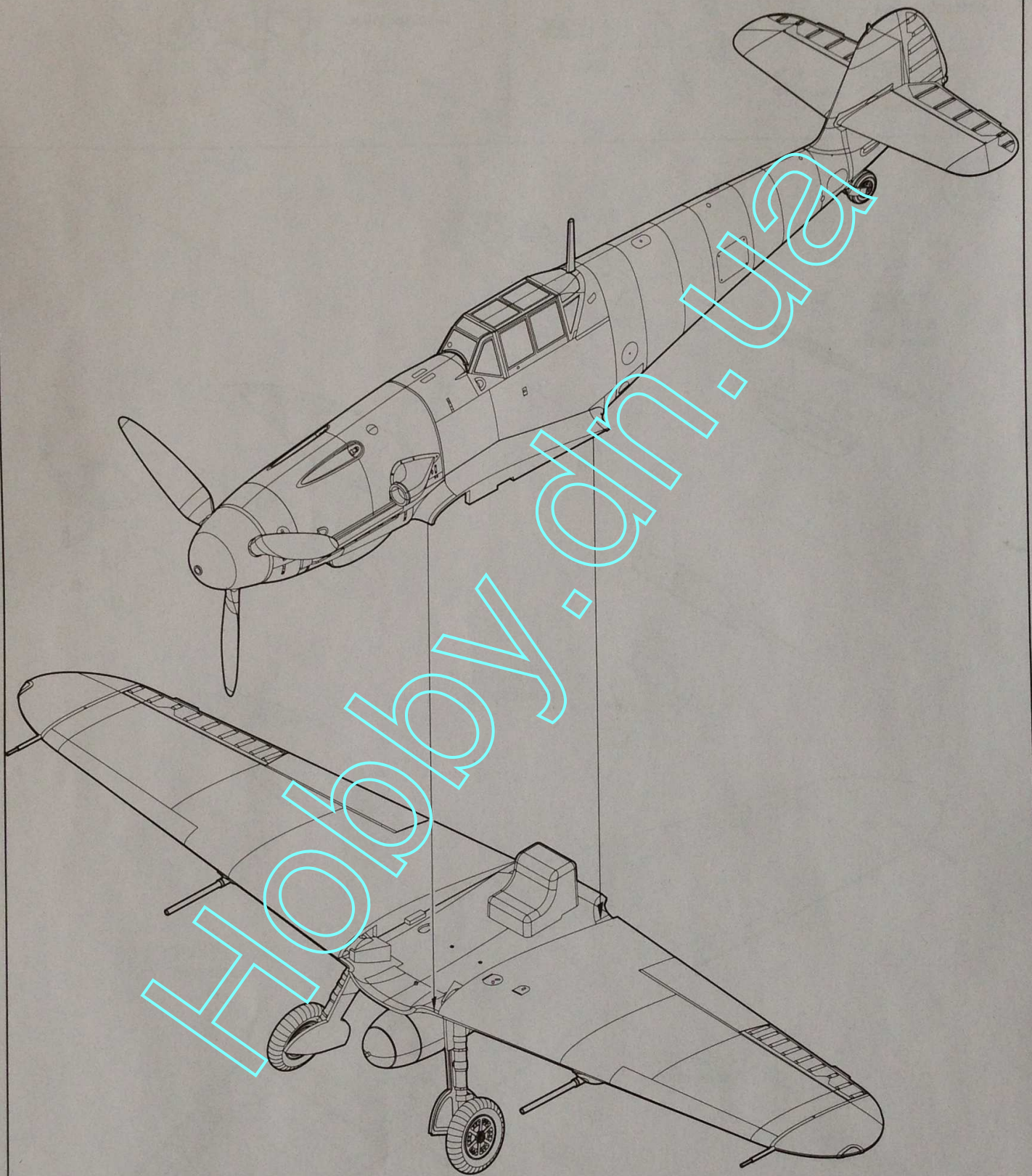

标贴与涂装

MARKING & PAINTING

BF109 F4

メッサーシュミット Bf109F-4 德国BF109 F4战斗机



I Bf109 F-4 "Black Chevron/Triangle and Bars" flown by Oberstleutnant Gunther Freiherr von Maltzahn Geschwaderkommodore JG 53, May 1942

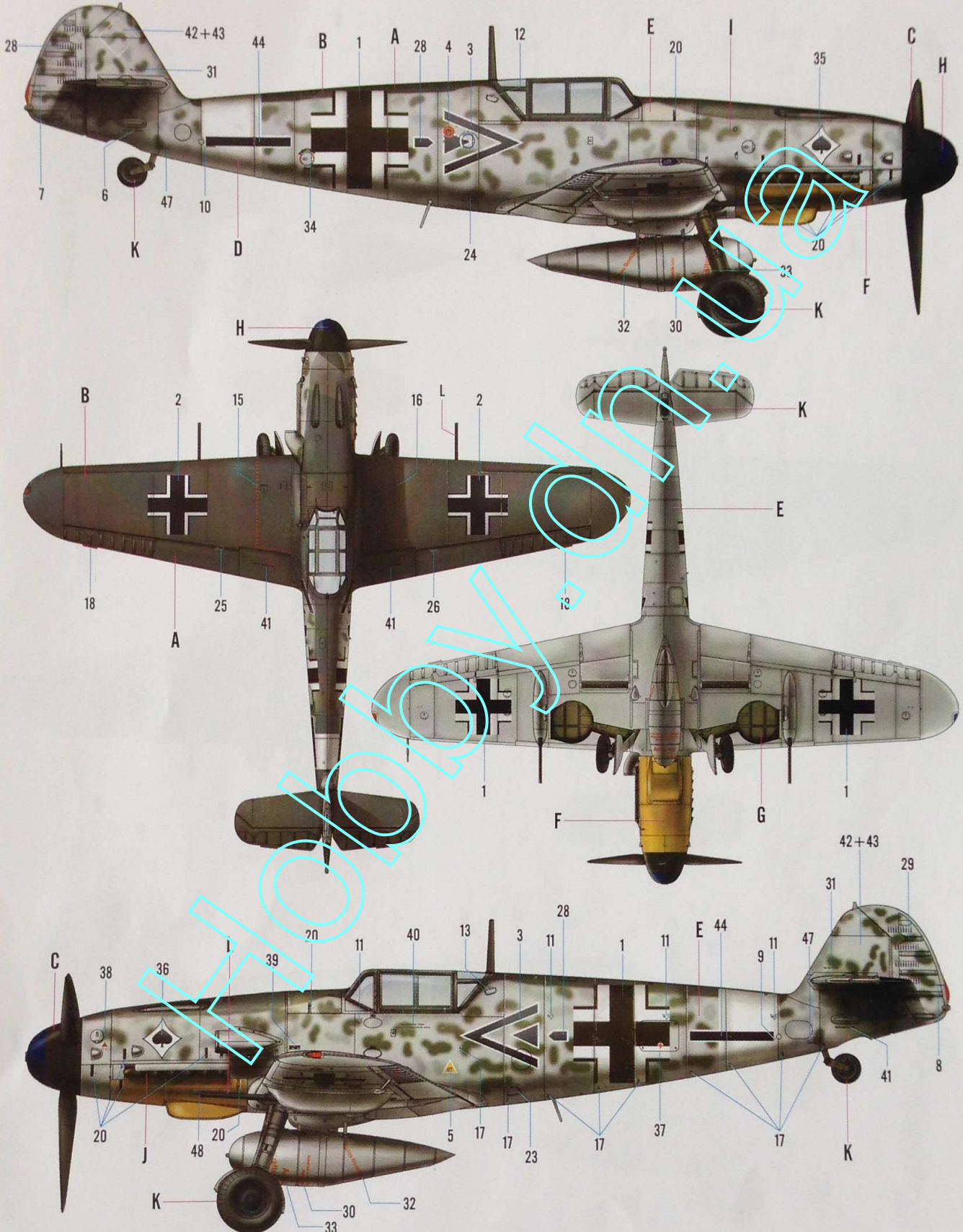

| Color | Mr.Hobby | Vállejo | Model Master | Tamiya | Humbrol | Color | Mr.Hobby | Vállejo | Model Master | Tamiya | Humbrol |
|-------------------------------|----------|---------|--------------|--------|---------|----------------------------|-----------|---------|--------------|--------|---------|
| A 灰绿色 RLM74 Gray Green | H 68 36 | 868 | --- | XF54 | 27 | D 白色 White Insignia | H 316 316 | 991 | 1745 | X2 | 22 |
| B 紫灰色 RLM75 Gray | H 69 37 | --- | --- | --- | --- | E 浅蓝色 Light Blue | H 67 115 | 906 | --- | XF23 | 65 |
| C 黑灰色 RLM66 Black Gray | H 116 | 866 | 1788 | XF24 | 32 | F 黄色 RLM04 Yellow | H 113 | --- | --- | A78 | --- |

NO.:81749

*Some paints may not be available in your country. Please check your local hobby shop for substitute

标贴与涂装

BF109 F4



MARKING & PAINTING

メッサーシュミット Bf109F-4 德国BF109 F4战斗机

II

Bf109 F-4(WK-Nr 5749) flown by Hauptmann Hans "Assi" Hahn, Gruppenkommandeur III/JG 2 "Richthofen", Summer 1941



| Color | Mr.Hobby | Vallejo | Model Master | Tamiya | Humbrol | Color | Mr.Hobby | Vallejo | Model Master | Tamiya | Humbrol |
|--------------------------------|------------|---------|--------------|--------|---------|-------------------------|-----------|---------|--------------|--------|---------|
| G 德国灰 RLM 02 Gray | H[70] 60 | 869 | --- | XF22 | --- | J 烧铁色 Burnt Iron | H[76] 63 | 863 | 1795 | X10 | 53 |
| H 蓝色 Blue | H[328] 328 | --- | 1772 | --- | 190 | K 胎黑色 Tire black | H[77] 137 | --- | --- | --- | --- |
| I 墨绿色 RLM70 Black Green | H[65] 18 | 897 | --- | XF27 | 91 | L 黑铁色 Steel | H[19] 20 | 864 | 1402 | --- | --- |

NO.:81749

* Some paints may not be available in your country. Please check your local hobby shop for substitute