

UNIVERSAL CARRIER I Mk I



















Cat. no. 72023

Scale 1/72



Project, design & artwork: Jarosław Leoniec
Research: Jarosław Leoniec & IBG crew

-  Element złożony we wcześniejszym etapie
Element assembled in previous step
-  Element po złożeniu w aktualnym etapie
Element after assembly in actual step
-  Wersja do wyboru
Version to choose
-  Kalkomania
Decal
-  Kolor farby
Paint colour
-  Część nie do użycia
Part not for use

	Gunze Mr.Col	Model Master Acrylic	Humbrol	Valleyo MC
black	 C002	4695	21	861
wood	 C043	4673	110	846
gunmetal	 C104	4681	53	863
olive drab	 C033	4842	155	889
leather	 C019	4674	62	843
bronze green	 C017	~4726	75	897
slate grey	 C036	~4846	31	893
light grey	 C097	4765	64	971
light stone	 C314	4813	121	819
dunkelgelb	 C329	4796	83	978

Przed montażem przeczytać instrukcję. Przestrzegać kolejności montażu podanego w instrukcji! Klej i farby nie wchodzi w skład zestawu.

Uwaga! Zdecydowanie sugerujemy użycie bardzo rzadkiego kleju - Tamiya Extra Thin Cement jest najlepszym wyborem. Montaż gąsienicy należy przeprowadzić dość szybko bo składnik gąsienica zachowuje miękkość przez kilkanaście minut i można ją wtedy wyginać i dopasowywać.

Please read instruction before assembly. Obey sequence of assembly like in instruction. Glue and paints not included.

Attention! We strongly suggest using a very thin glue - Tamiya Extra Thin Cement will be the best choice. Assembly of track please make in short period of time, because assembled track is still soft and can be fitted and bended.

Ramka J / Frame J

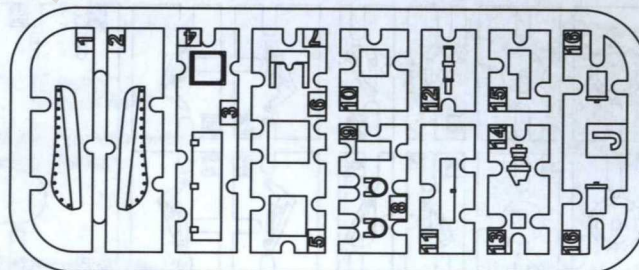

International Business Group
ul. Benedykta Hertza 2
04-603 Warszawa
Poland

tel +48 22 8159150
fax +48 22 8159151
ibgsc@ibg.com.pl
www.ibg.com.pl

Ramka bez oznaczenia literowego / No letter frame

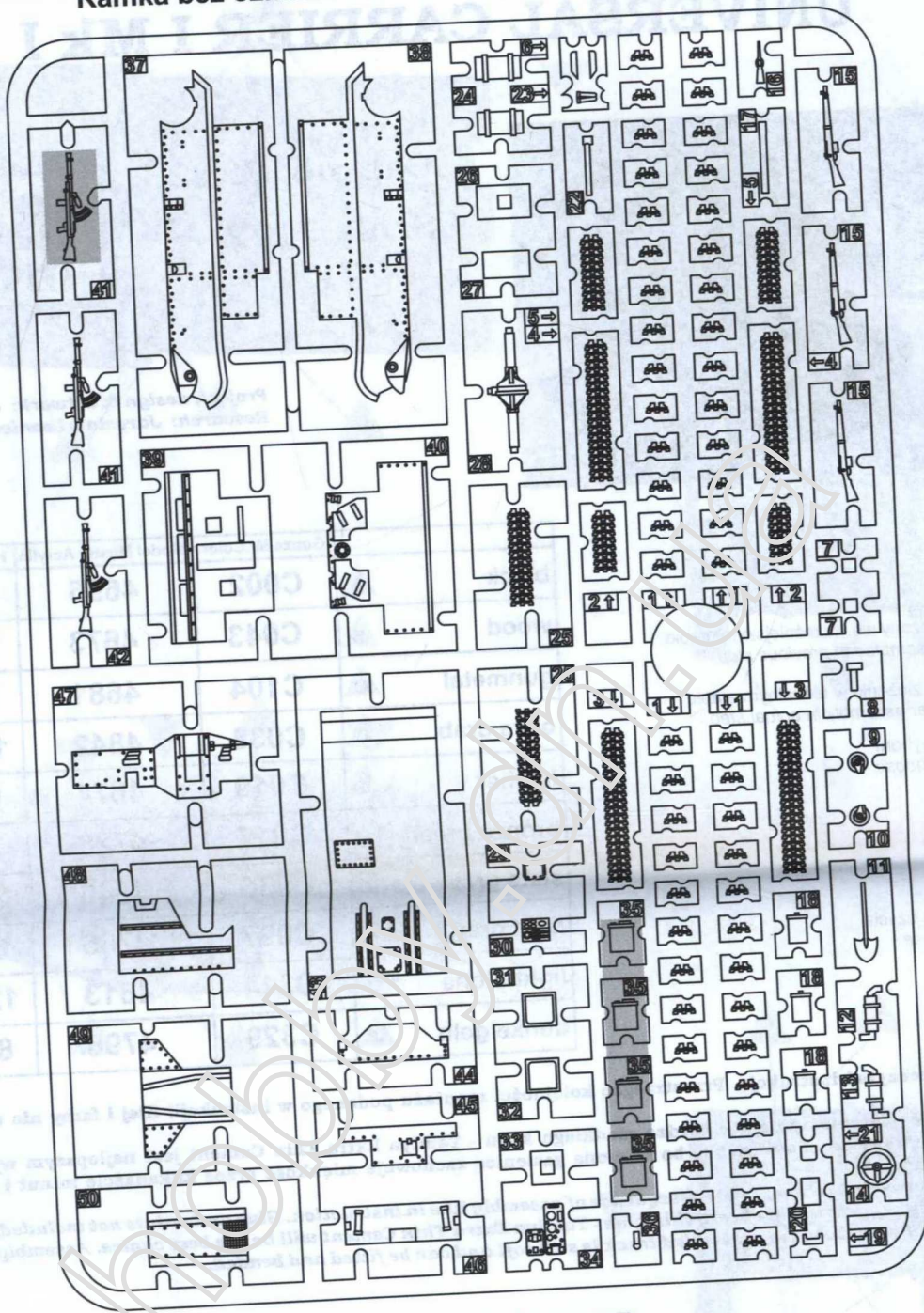

Ramka X / Frame X

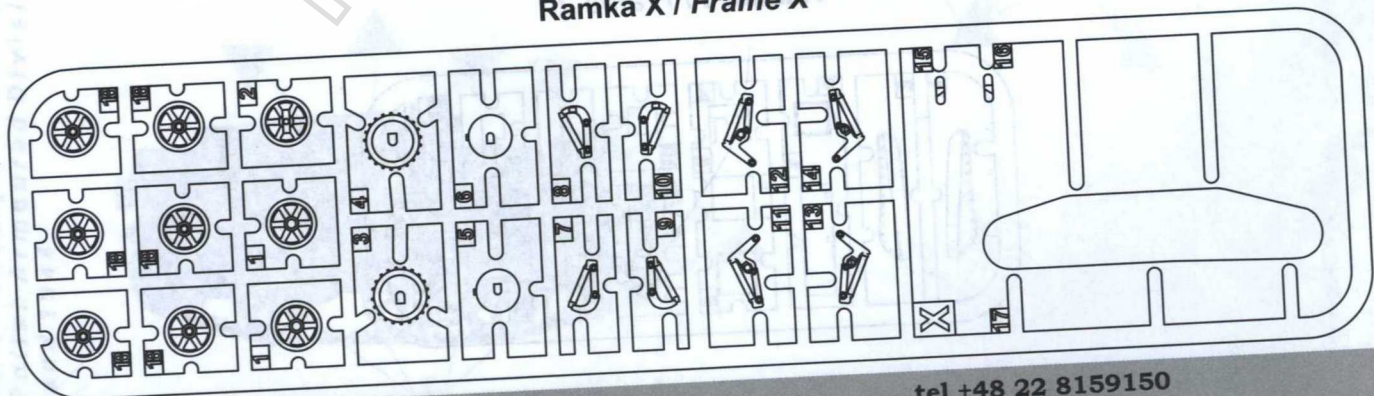

International Business Group
 ul. Benedykta Hertza 2
 04-603 Warszawa
 Poland

tel +48 22 8159150
 fax +48 22 8159151
 ibgsc@ibg.com.pl
 www.ibg.com.pl

T 142049 "C"

ETAP 1 Montaż gąsienicy
STEP 1 Track assembly

Uwaga! Zdecydowanie sugerujemy użycie bardzo rzadkiego kleju - Tamiya Extra Thin Cement jest najlepszym wyborem. Należy zmontować dwie gąsienice.
Attention! We strongly suggest using of very thin glue - Tamiya Extra Thin Cement will be the best choice. Two tracks have to be assembled.

- I** Montuj gąsienicę na twardej, płaskiej powierzchni. Posmaruj odrobiną kleju i zsuń do złączenia używając dwóch igieł.
Assembly track on hard, flat surface. Add some glue and slide together using two needles.

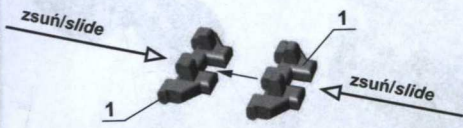

- II** Dociśnij do powierzchni dla wyrównania.
Press to flat surface to align.

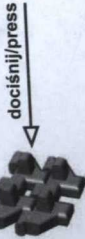

- III** Analogicznie dodaj kolejne ogniwa.
Analogically add two track links.

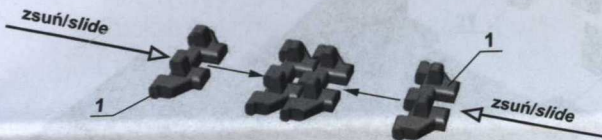

- IV** Dociśnij do powierzchni dla wyrównania.
Press to flat surface to align.



- V** Złóż dwa odcinki - z 10 ogniw i z 11 ogniw.
Assembly two segments - 10 track links and 11 track links.

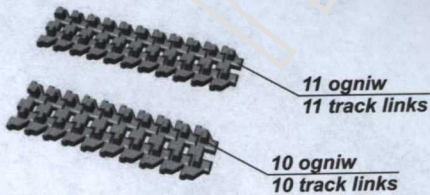

- VI** Zegnij i dopasuj oba odcinki używając wzornika.
Bend and fit both segments using pattern.

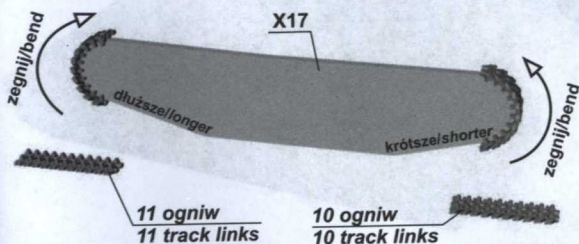

- VII** Dopasuj i sklej pierwszą część gąsienicy używając wzornika.
Fit and glue first part of track using pattern.

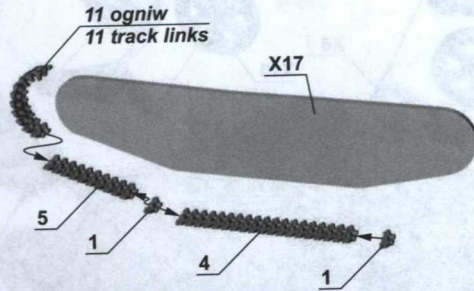

- VIII** Dopasuj i sklej drugą część gąsienicy używając wzornika.
Fit and glue second part of track using pattern.

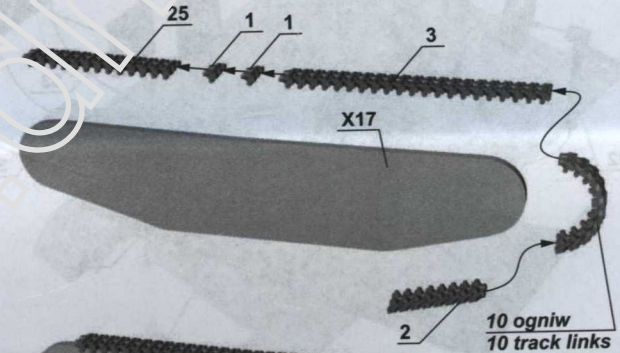

- IX** Sprawdź dopasowanie obu części używając wzornika. Nie skleжай ich razem!
Check fitting both parts of track using pattern. Don't glue them together!

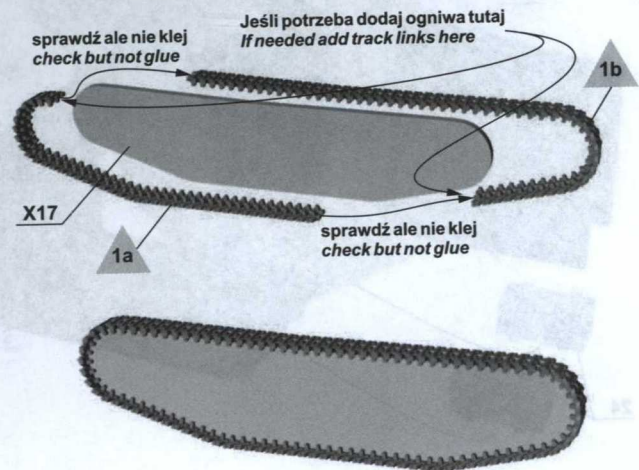

**ETAP 2
STEP 2**

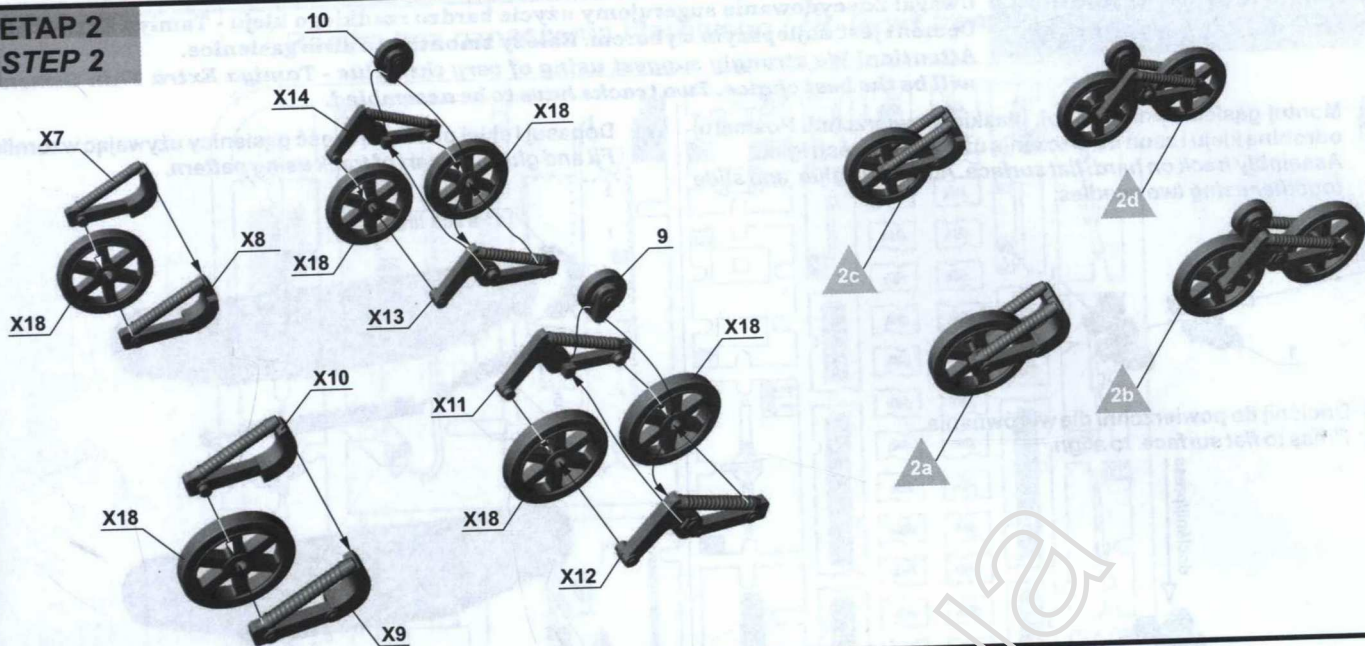

**ETAP 3
STEP 3**

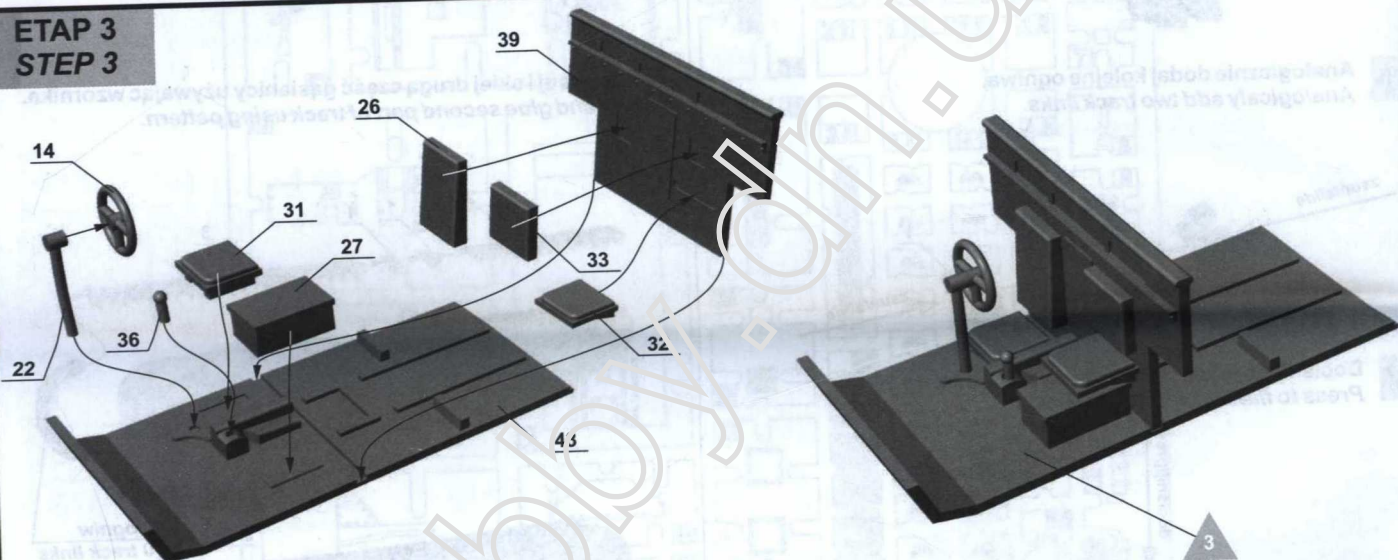

**ETAP 4
STEP 4**

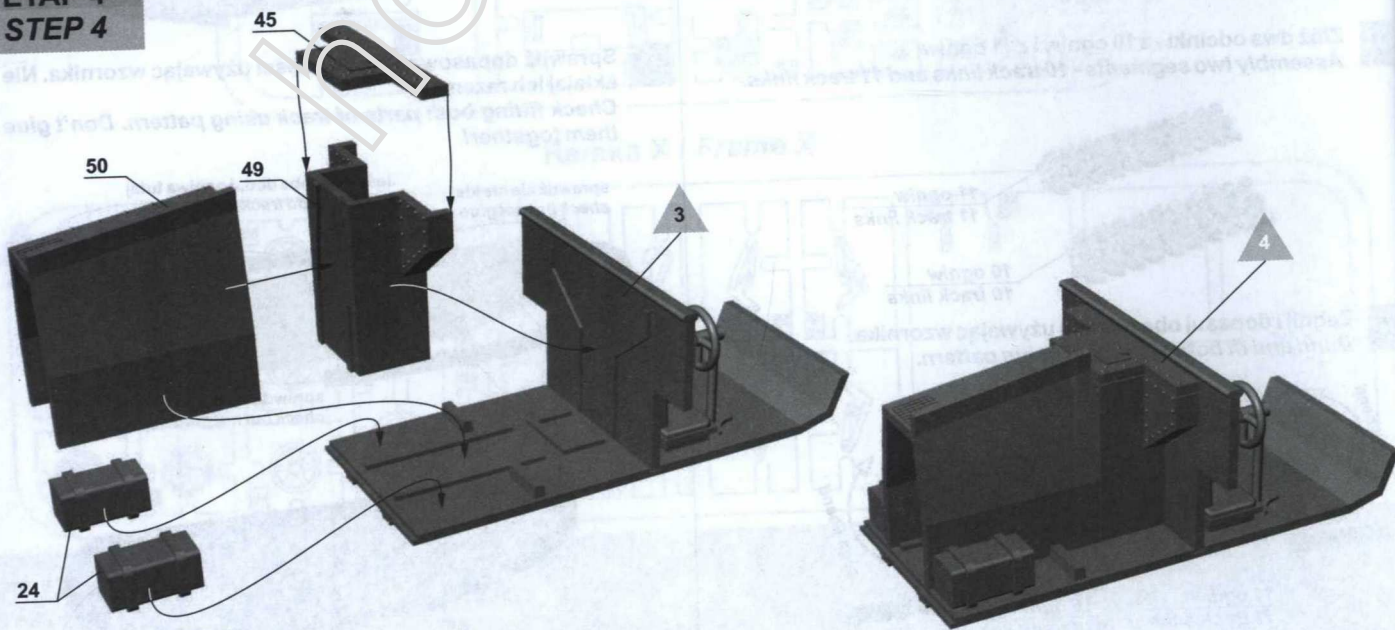

ETAP 5
STEP 5

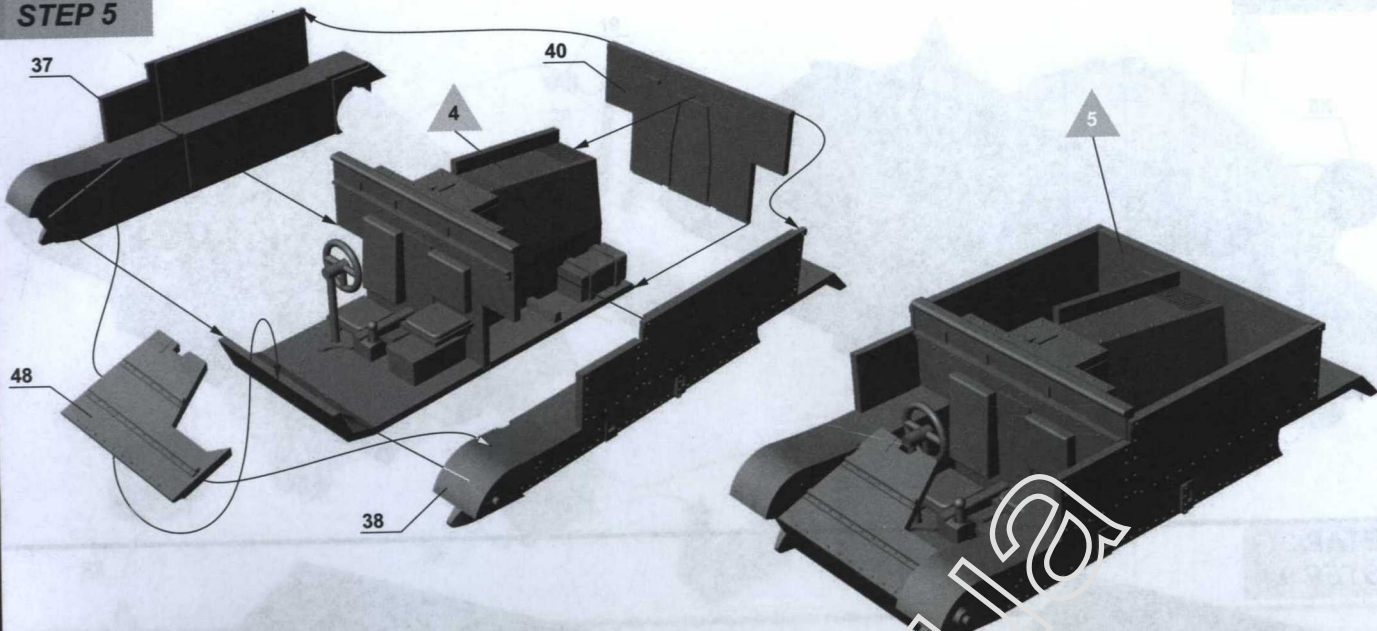

ETAP 6
STEP 6

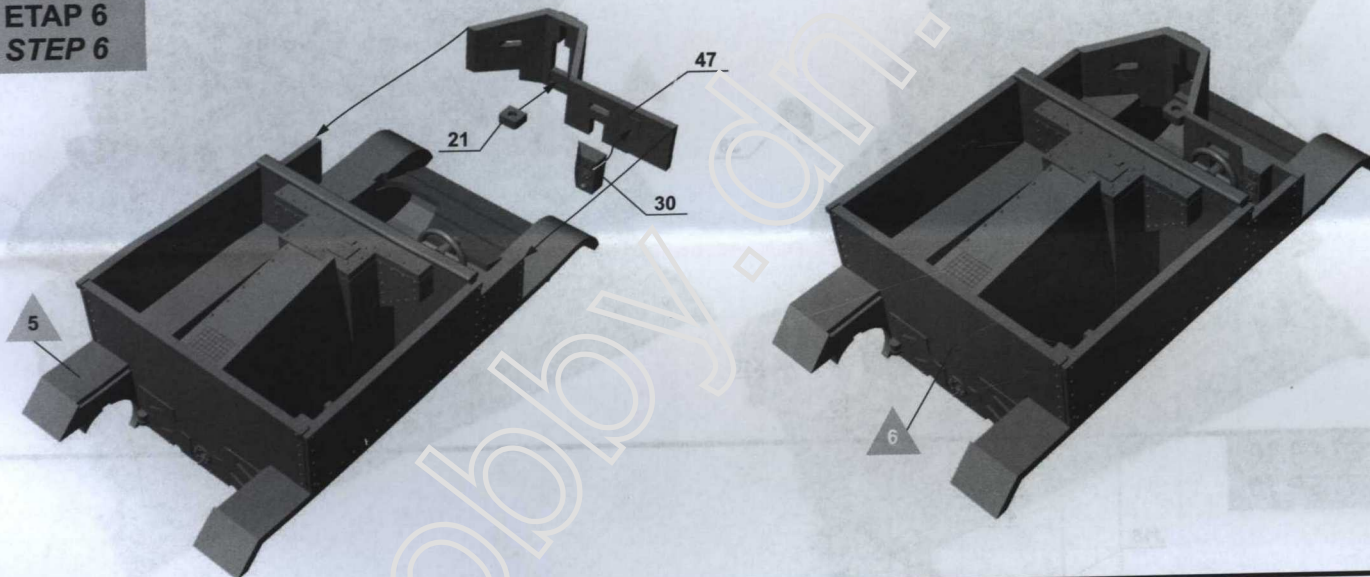

ETAP 7
STEP 7

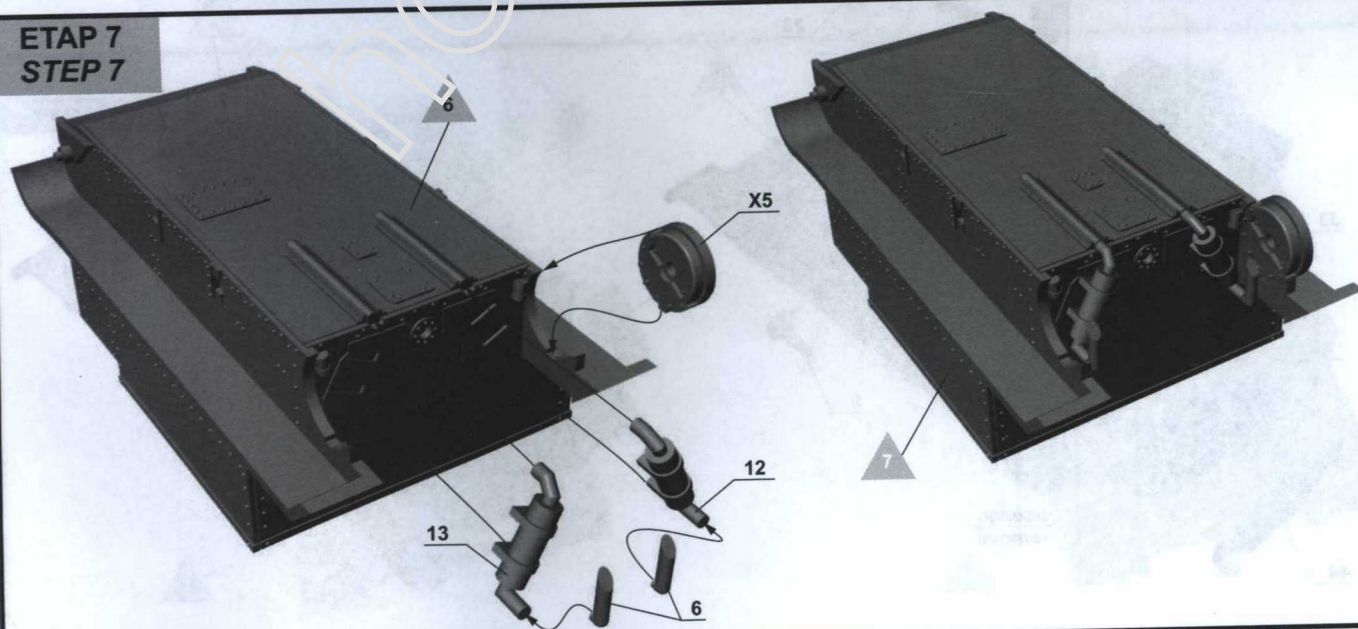

ETAP 8
STEP 8

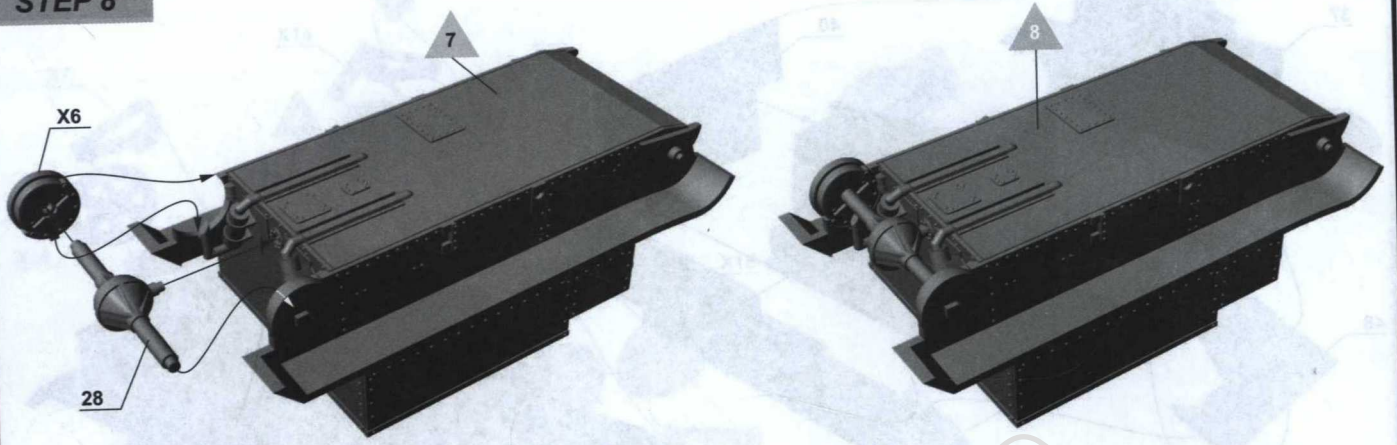

ETAP 9
STEP 9

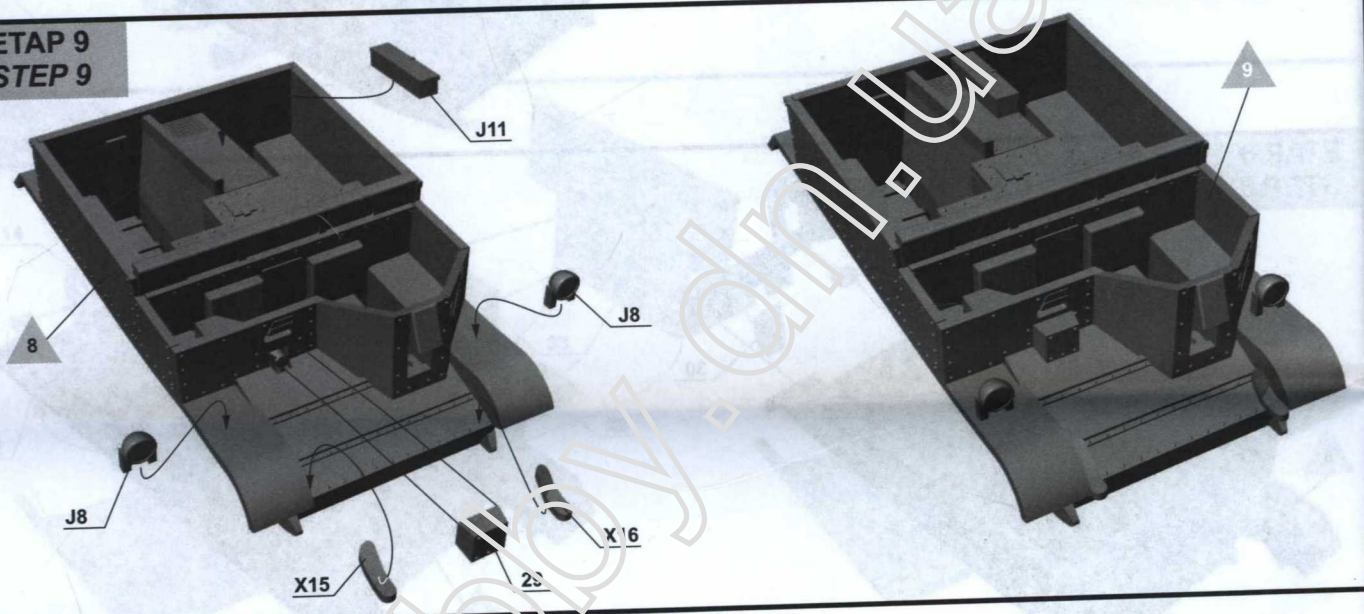

ETAP 10
STEP 10

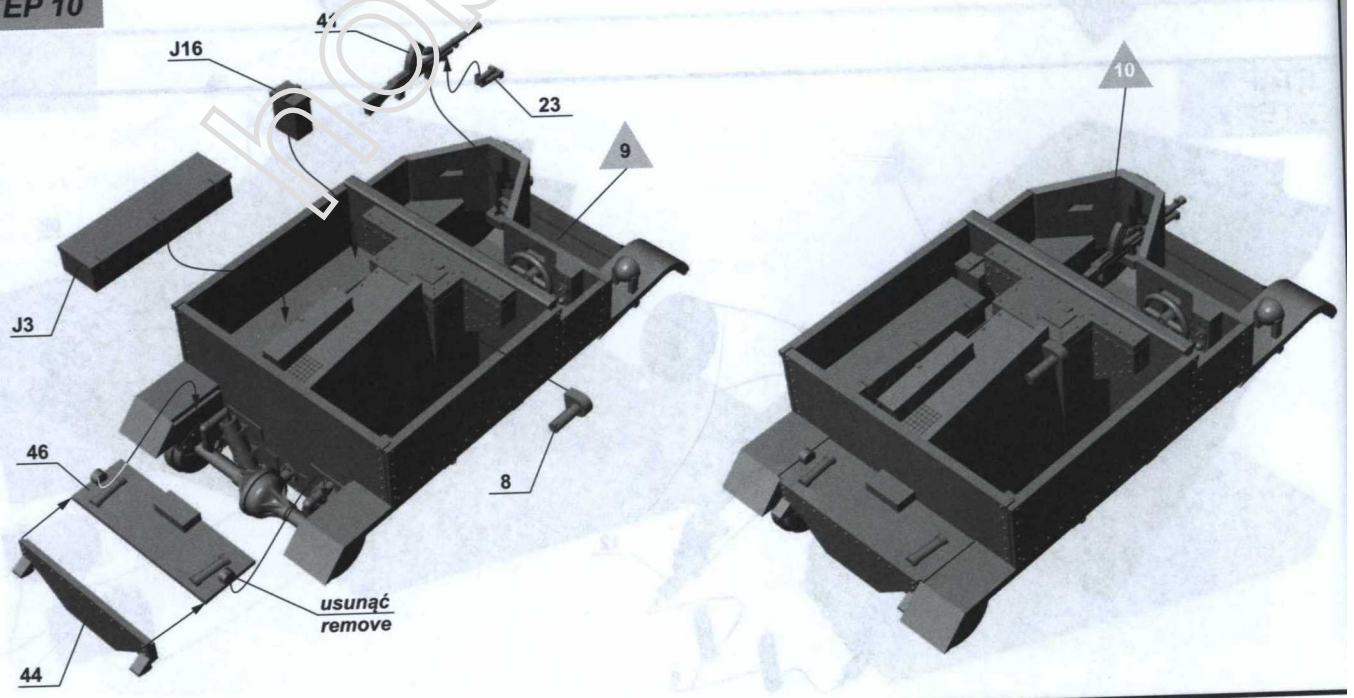

ETAP 11
STEP 11

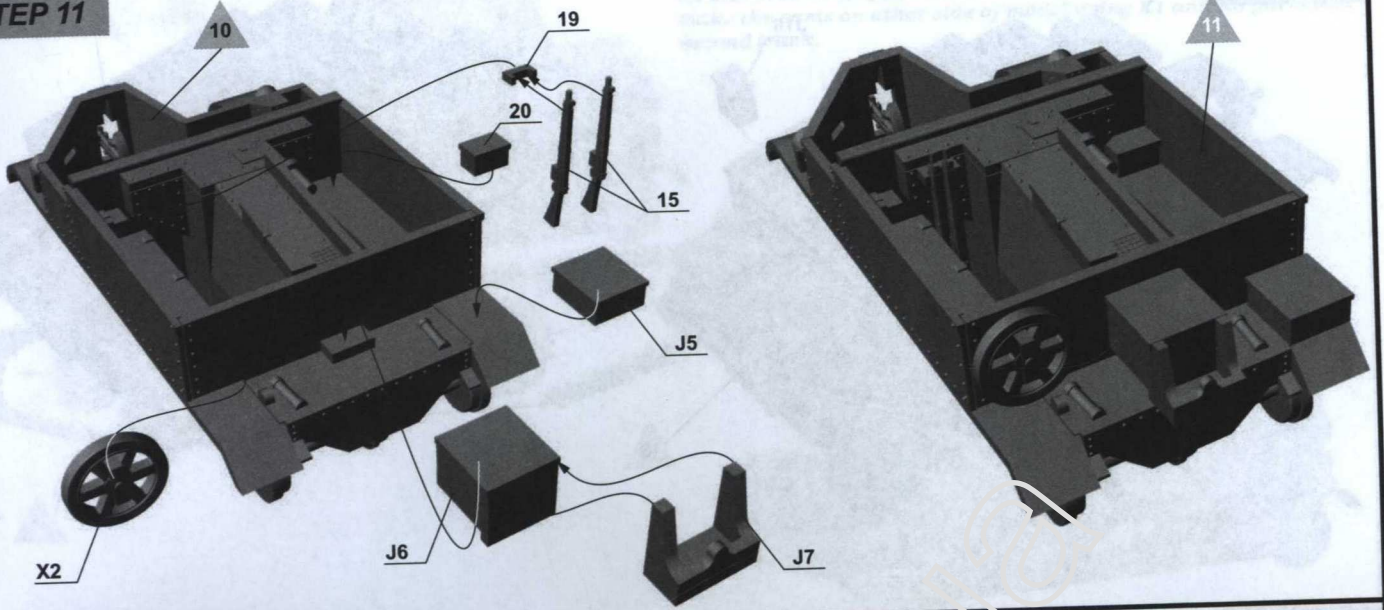

ETAP 12
STEP 12

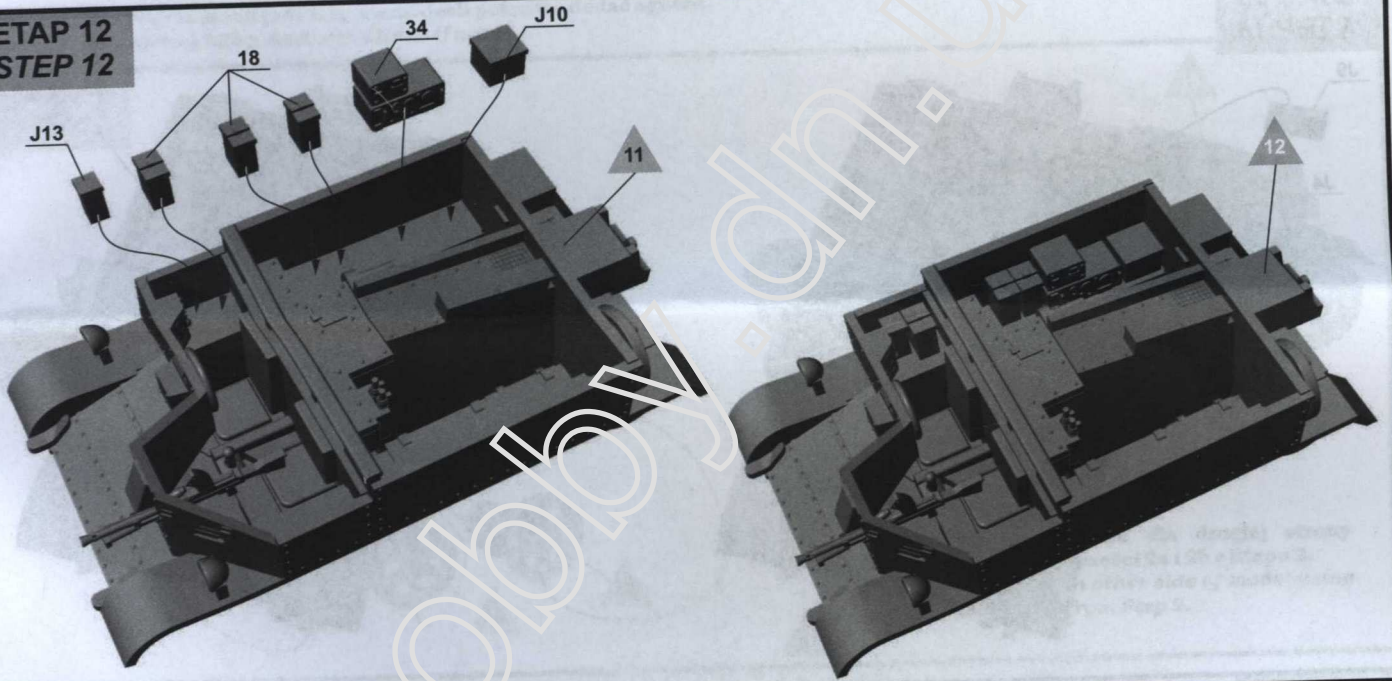

ETAP 13
STEP 13

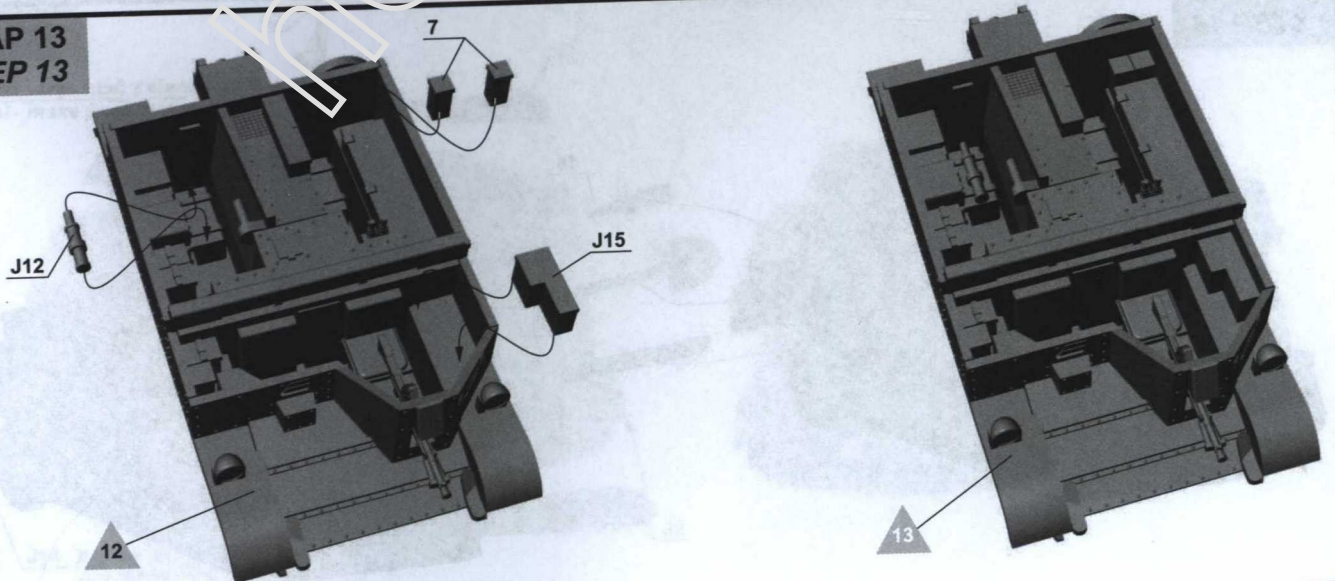

**ETAP 14
STEP 14**

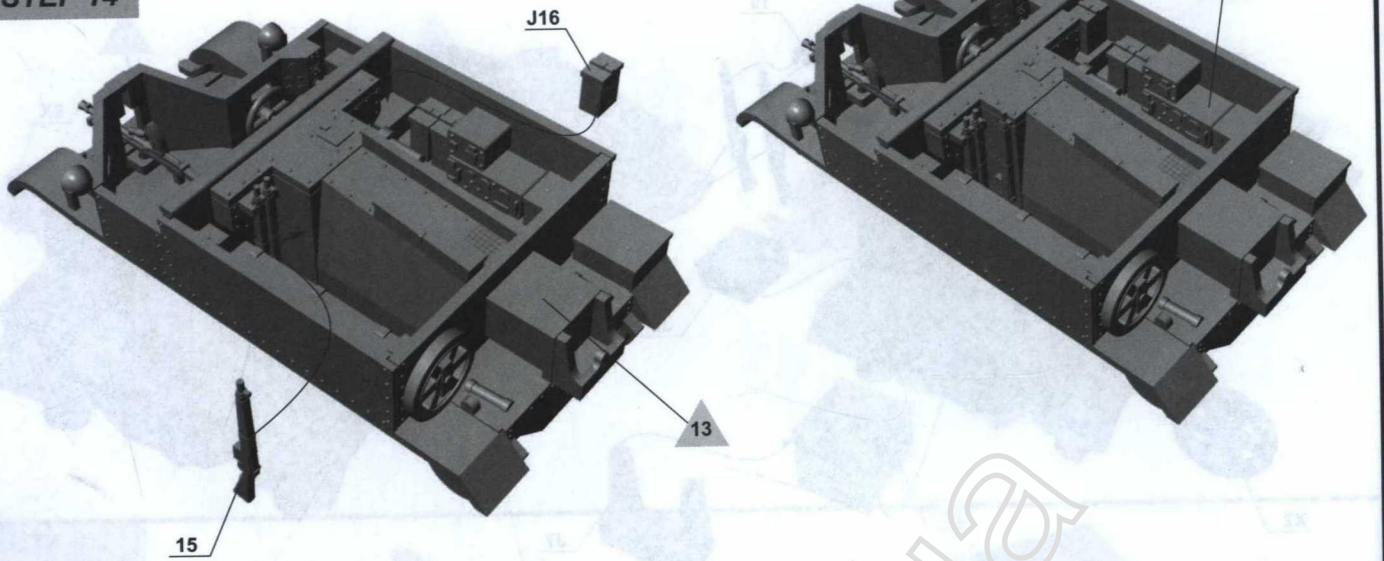

**ETAP 15
STEP 15**

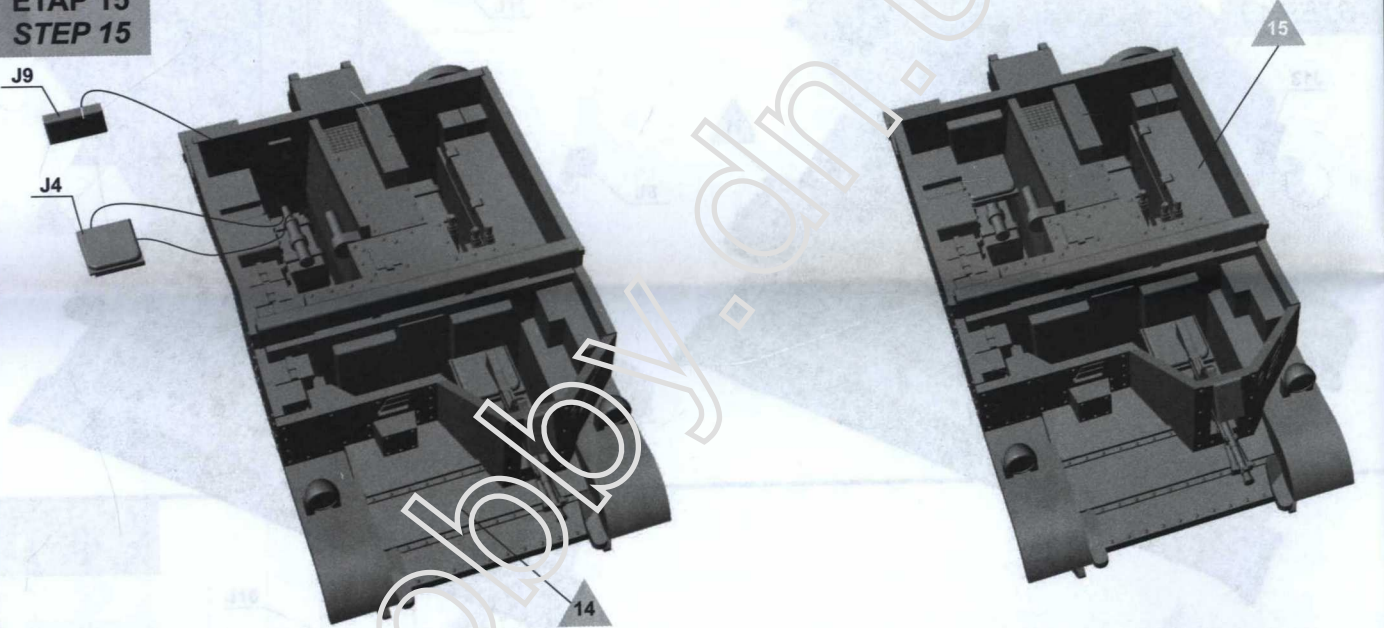

**ETAP 16
STEP 16**

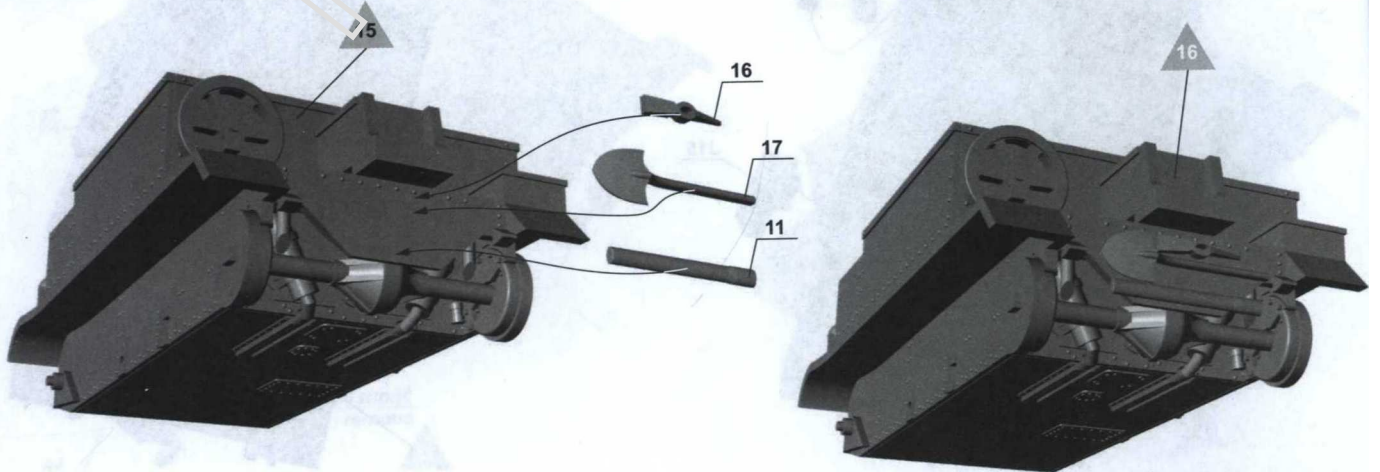

**ETAP 17
STEP 17**

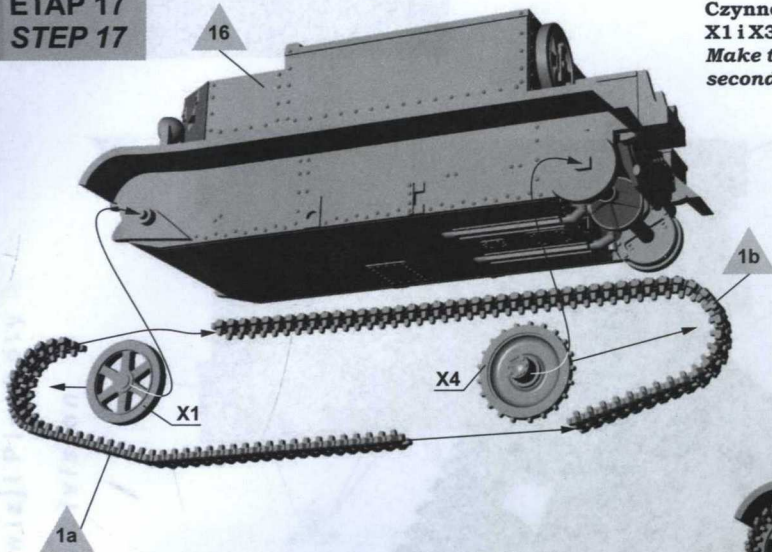

Czynności powtórzyć dla drugiej strony modelu używając części X1 i X3 oraz drugiej łańcucha.
 Make the same on other side of model using X1 and X3 parts and second track.

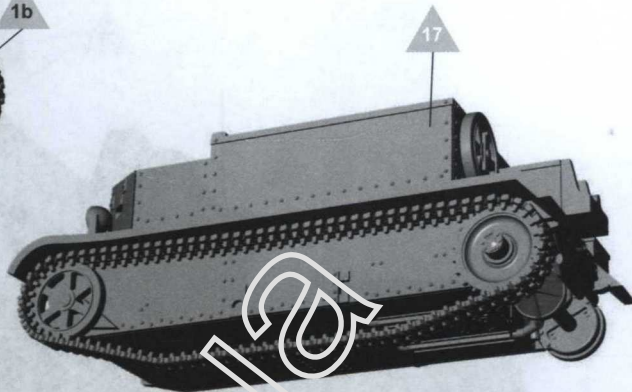

Sprawdzić pasowanie przed przyklejeniem. Jeśli potrzeba dodać ogniwa.
 Check fitting before gluing. Add track links if needed.

**ETAP 18
STEP 18**

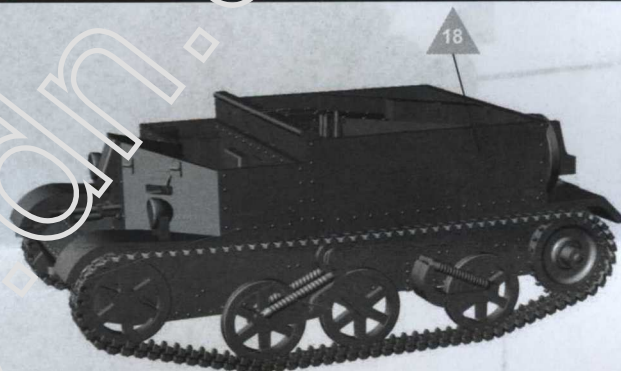
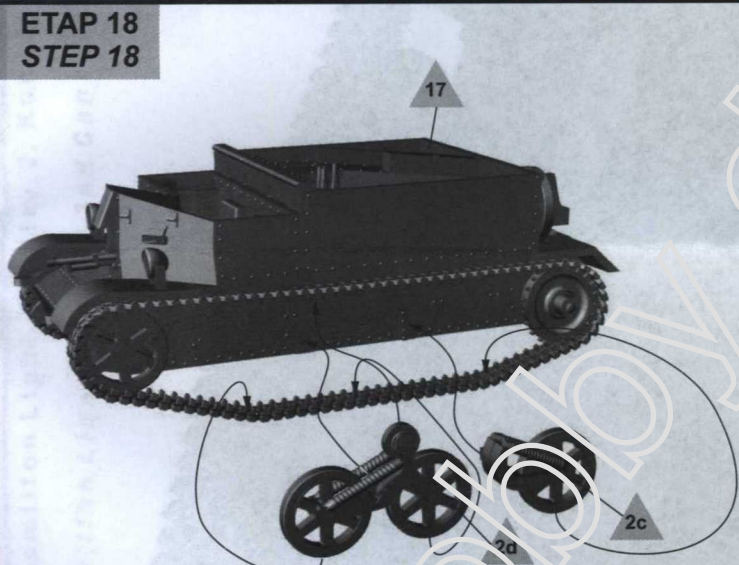

Czynności powtórzyć dla drugiej strony modelu używając części 2a i 2b z Etapu 2.
 Make the same on other side of model using 2a and 2b parts from Step 2.

**ETAP 19
STEP 19**

antena - wykonać z cienkiego drutu
 aerial - make from thin wire

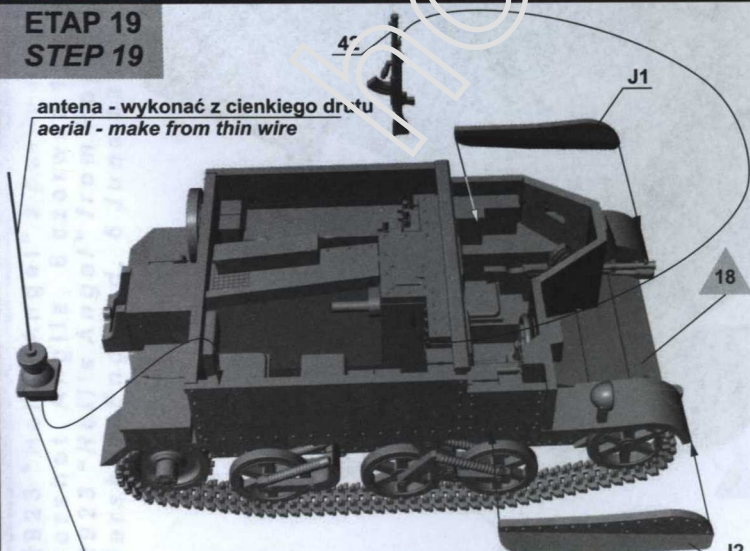

J14 nie dla każdego wariantu malowania
 not for every painting scheme

