

BIG BOY Locomotive

Die amerikanischen „Big Boys“ gehören zu den längsten und größten jemals gebauten Serien-Dampflokomotiven der Welt. Während der späten 30er Jahre nutzte Union Pacific oftmals Hilfslokomotiven um Züge von Ogden, Utah nach Wasatch über einen steilen Pass zu ziehen. U.P. wollte dieses System vereinfachen und beauftragte die eigene Entwicklungsabteilung eine neue Lokomotive zu entwerfen, die einen 3.600 t-Zug (bis max. 4.200 t) den steilen Pass hinaufziehen konnte. Die 25 Big Boy-Lokomotiven wurden in 2 Gruppen gebaut. Die erste Gruppe, genannt Klasse 1, wurde ab 1941 gebaut. Die zweite Gruppe (Klasse 2) wurde in 1944 gebaut. Der letzte Güterzugtransport der durch eine Big Boy-Lok bewältigt wurde, fand im Juli 1959 statt. Die meisten Big Boy wurden in 1961 außer Dienst gestellt.

BIG BOY Locomotive

The American Big Boys are some of the longest and largest steam locomotives ever built anywhere in the world. During the late thirties Union Pacific often used auxiliary engines to haul trains from Ogden, Utah up a steep pass to Wasatch. U.P. wished to simplify this system and instructed their own development department to design a new locomotive capable of hauling a 3,600 ton train (max 4,200 tons) up the steep pass. The 25 Big Boy locomotives were built in 2 groups. The first group, called the Class 1, was built from 1941. The second, Class 2, was built in 1944. The last goods train was hauled by a Big Boy loco in July 1959. Most Big Boys were retired from service in 1961.



Form hergestellt und in Eigentum von Revell AG/Revell Magyarország Inc. Widersprüchliche Nachahmungen werden gerichtlich verfolgt.
 Ce produs est propriété de la société Revell AG/Revell Magyarország Inc. Toute réimpression ou duplication frauduleuse sera poursuivie en justice.
 Modelado y en propiedad de Revell AG/Revell Magyarország Inc. Infracciones lícitas serán perseguidas por la ley.
 Forma prodotta dalla Revell AG/Revell Magyarország Inc. e di proprietà della stessa impresa. In caso di produzione illegittima contro ogni iniziativa ufficiale.
 Model in Revell AG/Revell Magyarország Inc. tulajdonában és megalkotásán. Licitált másolatok ellenőrzésére hivatalos hatóságok tevékeny.
 Formen er produceret og ejet af Revell AG/Revell Magyarország Inc. Eftertagning uden tilladelse vil bli gjenstand for retslig forfølgning.
 Produkta i posesz wlasności firmy Revell AG/Revell Magyarország Inc. Nielegalne podrobienie jest zabronione pod odpowiedzialnością sądową.
 Model, Revell AG/Revell Magyarország Inc. firmájának tulajdonában álló eredeti modell. Készen egyen létező másolatok ellenőrzésére hivatalos hatóságok.
 A forma előállítja és a tulajdonjoga Revell AG/Revell Magyarország Inc. A jogellenes másolatok ellenőrzésére hivatalos hatóságok.

Model manufactured by and property of Revell AG/Revell Magyarország Inc. Illegal imitations are subject to prosecution.
 Forme vervaardigd door en eigendom van Revell AG/Revell Magyarország Inc. Overstichtige nabootingen worden gerechtelijk vervolgd.
 Forma produsida e de proprietate de Revell AG/Revell Magyarország Inc. Copii ne autorizate serão processada juridicamente como determinado na lei.
 Modello fabbricato e in proprietà della Revell AG/Revell Magyarország Inc. All'ingenuità belivola sarà inflitta ogni sanzione.
 Formen er fremstillet af Revell AG/Revell Magyarország Inc. som ejer af opretningen. Lovstraffede efterligninger følger.
 Modelis gyártásának a jogszabályok szerinti tulajdonos Revell AG/Revell Magyarország Inc. Tilos jogszabályok megsértésével másolatok készítése.
 H jupplet korazodubnyie na spuzhlye etny dimitoplye Revell AG/Revell Magyarország Inc. O nepozovoye puzhlye bye strafitelnoye zakonodavstvom.
 Tær byi ryshon formu Revell AG/Revell Magyarország Inc. a je jelye vlastnostin. Post nezakonnyie razpuzhdeniye se bude postavljen sudnyie razsyt.
 Forma je proizvedena i je vlasništvo Revell AG/Revell Magyarország Inc. Neovoblene kopije biće pravnio kažnjene.

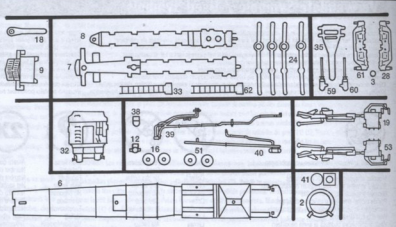
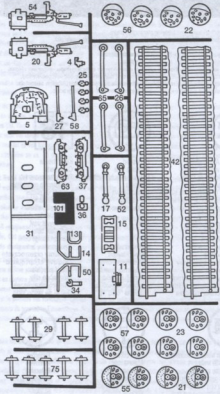

■ Nicht benötigte Teile
 Parts not used
 Pièces non utilisées
 Niet benötigde onderdelen
 Peças não utilizadas
 Partii non uzate
 Teile anvárada dólár
 Tarpeettomat osat

Ikke nødvendige delar
 Delar som ikke er nødvendige
 Неиспользуемые детали
 Elementy nepotrebne
 μη χρησιμοποιούμενα εξαρτήματα
 Gerekless parçalar
 Nepotrebni díly
 Nem használt alkatrészek
 Nepotrebni deli

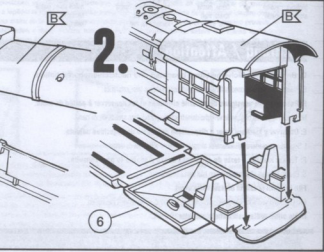
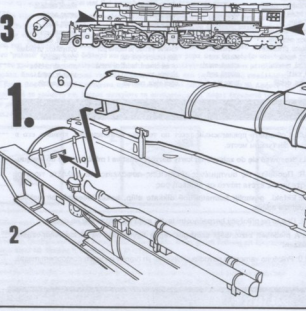
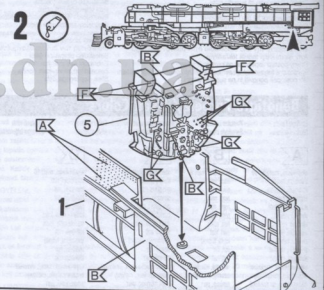
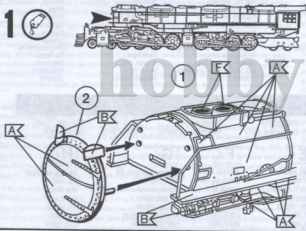
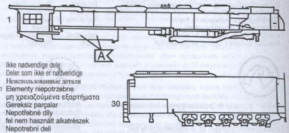

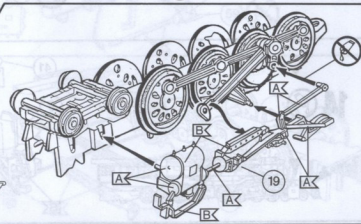
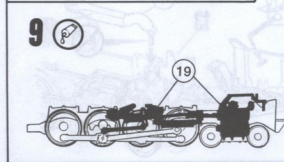
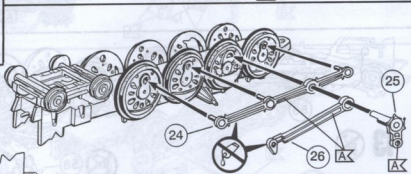
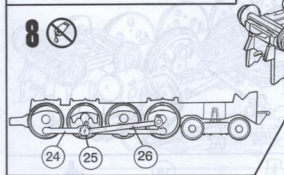
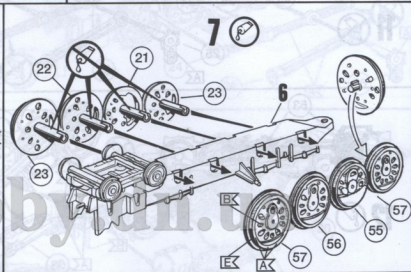
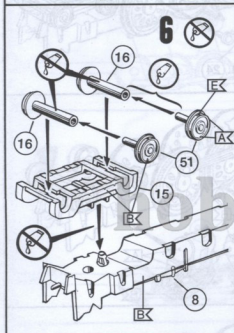
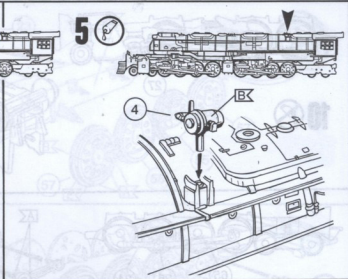
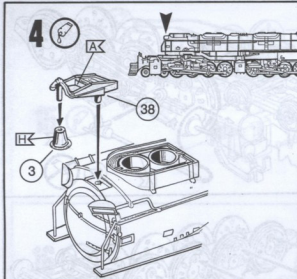

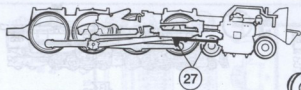

10

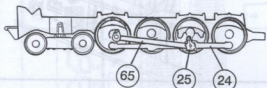
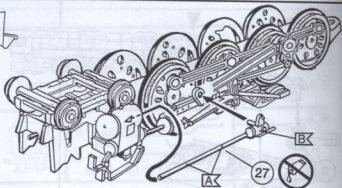

11

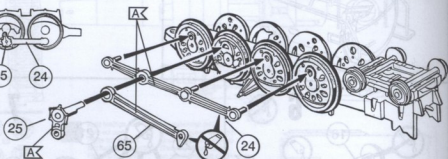

12

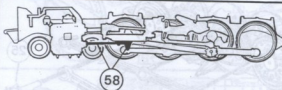
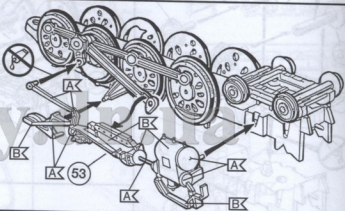

13

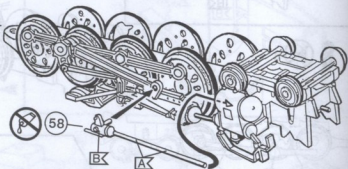

14

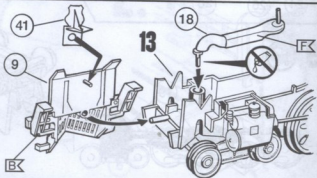

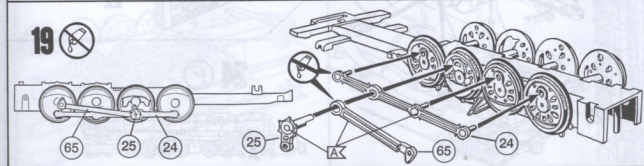
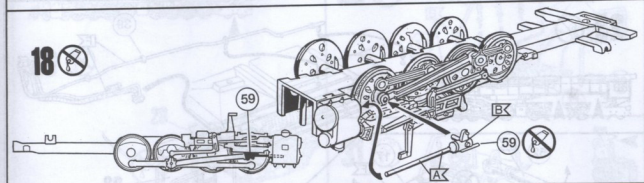
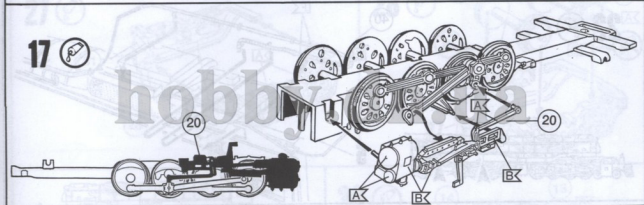
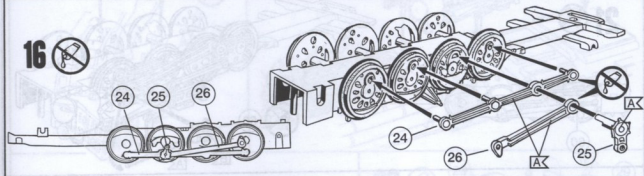
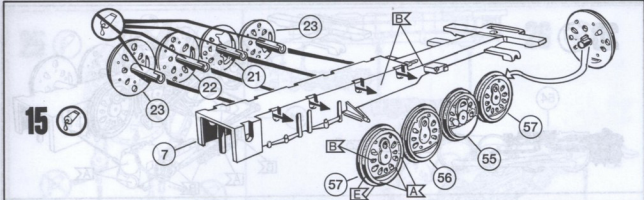

20 

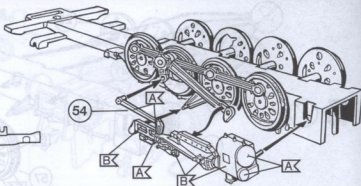
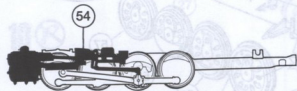

21 

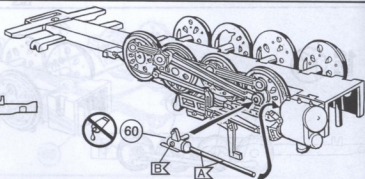
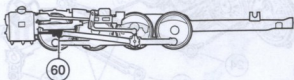

22 

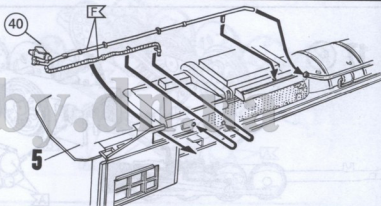

23 

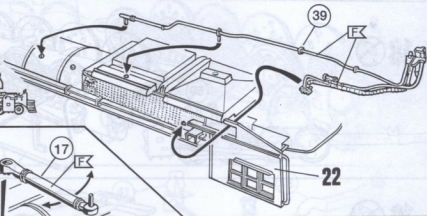
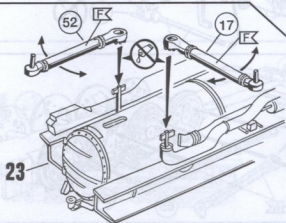

24 



25

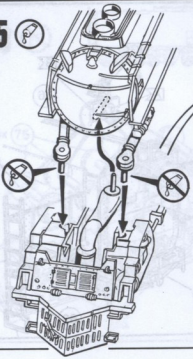

26

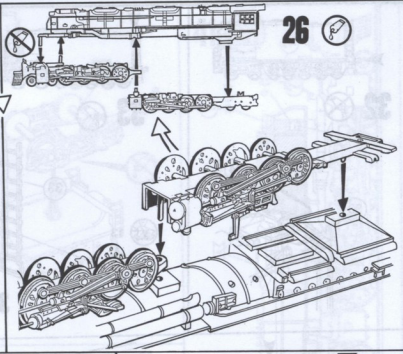

27

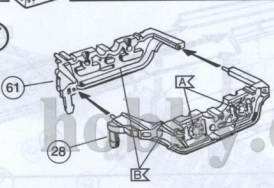

28

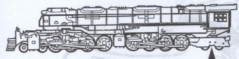
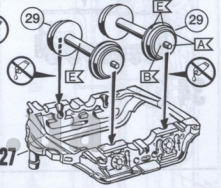

29



28

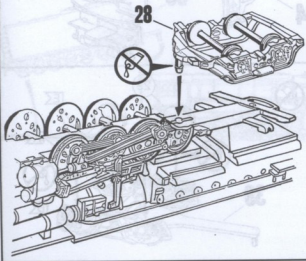

30

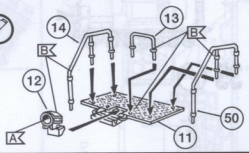

31

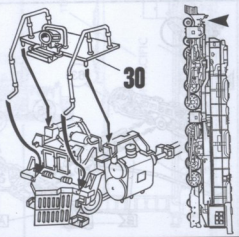

32 

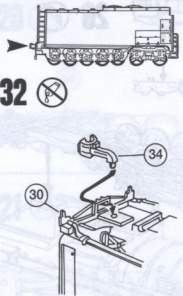

33 

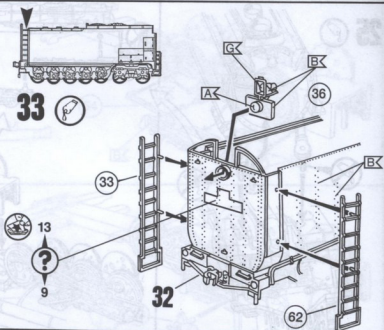

34 

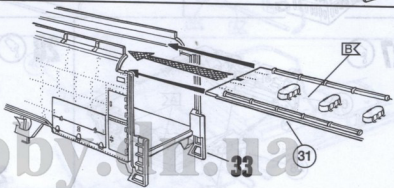
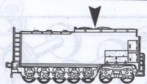

35 

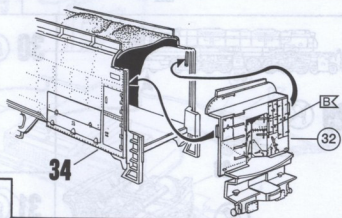

36 

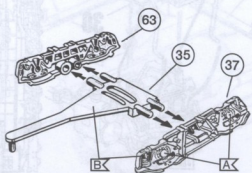

37 

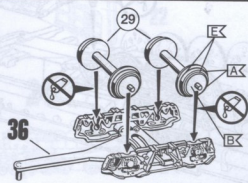

38

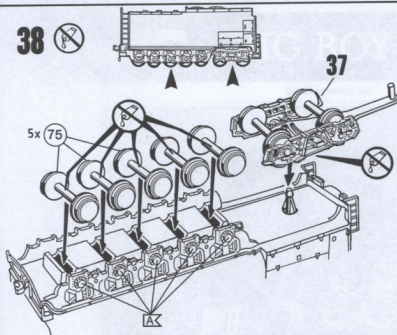

41

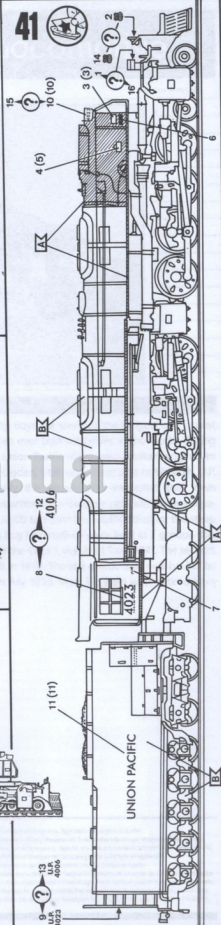

39

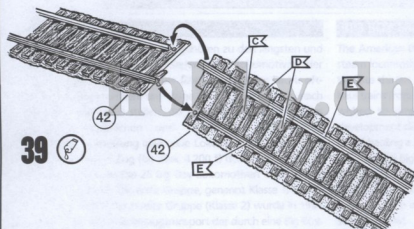

40

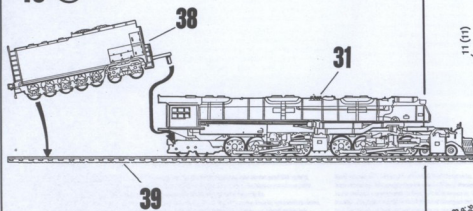

U.S. 4023
U.S. 4004