

MIKOYAN-GUREVICH MiG-23UB Flogger-C

Production began in 1970 at the plant in Irkutsk, with the production machine designated the "MiG-23UB". (MiG-27s built at the Irkutsk plant were painted with a fake rear canopy before rollout to trick US satellite intelligence into believing the Irkutsk plant only made MiG-23UBs.) The MiG-23UB was quickly updated in 1971 with the "Edition 3" dogtooth wing with leading-edge flaps and the ability to carry ferry tanks. Some early production machines had the Sapfir-21 radar, but most were built with ballast in place of the radar, the radar having proven more bother than it was worth in practice. Most or all production had the R-27F2-300 engine. Late production had improved flight-control systems, which were retrofitted to some early production.

МиГ 23УБ — Первый полет на прототипе МиГ-23УБ (23-51/1, бортовой номер 251) был выполнен 10 апреля 1970 г. летчиком-испытателем М.М. Комаровым. В том же году самолет был запущен в серийное производство на Иркутском авиазаводе. Позже был создан вариант МиГ-23УМ, конструктивно близкий к МиГ-23МЛ. Серийное производство МиГ-23УБ и МиГ-23МЛ осуществлялось на Иркутском авиазаводе в 1970-78 гг. С 1971 г. серийные МиГ-23УБ оснащались крылом III редакции, обеспечивавшим применение ПТБ, и двигателем Р27Ф2М-300 тягой 10000 кгс. По боевым возможностям "спарка" значительно уступала одностепенным машинам из-за отсутствия БРЛС, теплосенсора и ракет "воздух-воздух" средней дальности. Производство МиГ-23УБ в Иркутске для ВВС Советского Союза продолжалось до 1978 г., а на экспорт - до 1985 г., всего было построено свыше 1000 "спарок". В 1998 г. АНПК "МИГ" разработаны предложения по модернизации самолета МиГ-23УБ (МиГ-23УБ-99), предусматривающие внедрение современных систем диалога с экипажем, цифровой вычислительной техники, нового вооружения, за счет чего должен резко возрасти боевой и учебный потенциал самолета.

Размах крыла, м минимальный - 7.78, максимальный - 13.97. Длина, м 6.70 Высота, м 4.82 Тип двигателя 1 ТРДФ Р-27Ф2М-300 Максимальная скорость, км/ч: 2200 Практический потолок, м 15800, Экипаж, чел 2 Вооружение: одна 23-мм пушка ГШ-23Л (боекомплект 200 патронов), Боевая нагрузка - 1600 кг на узлах подвески: УРВВ Р-3С и Р-13М, УРВП Х-23, НАР и свободнопадающие бомбы

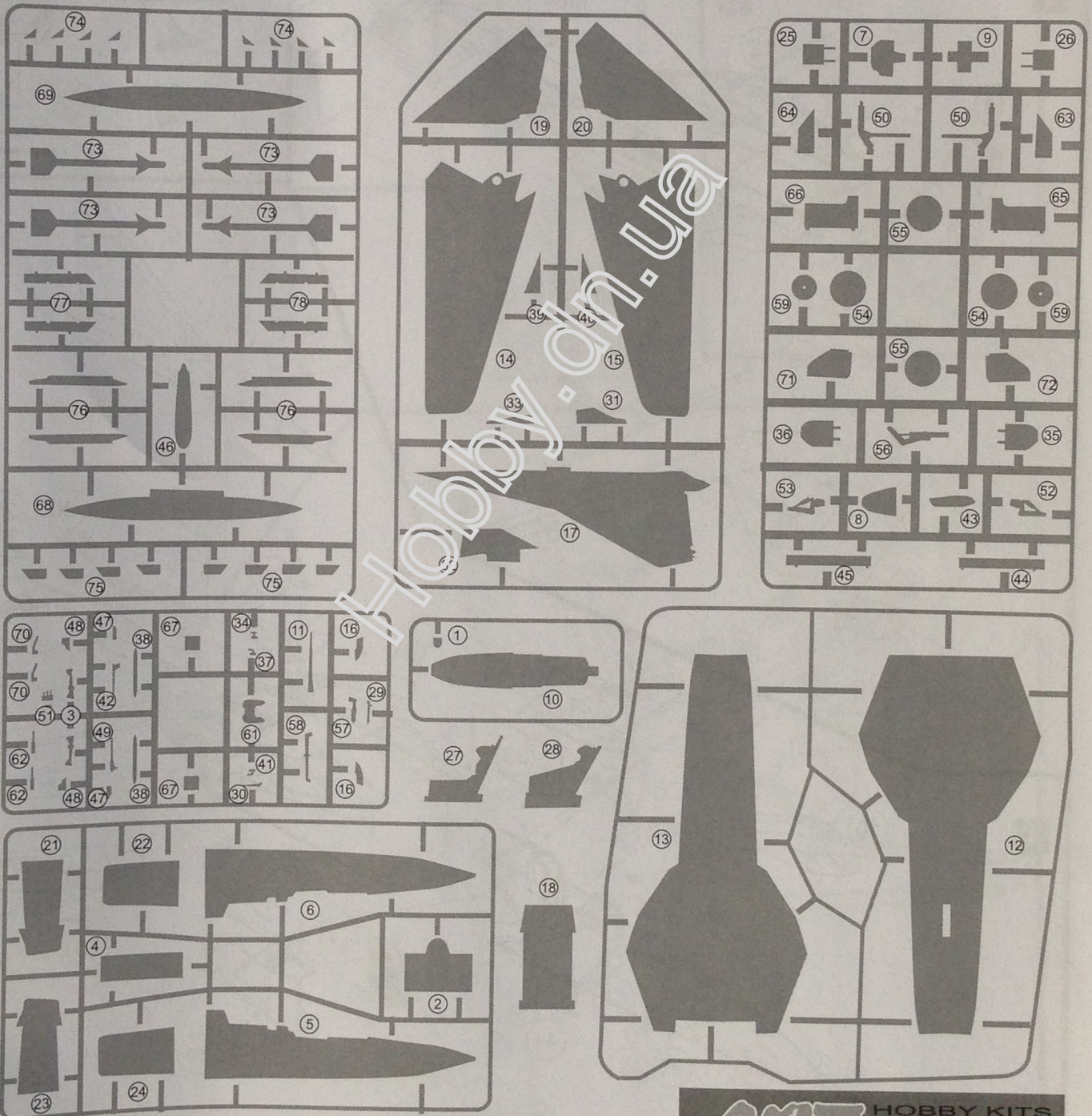

1

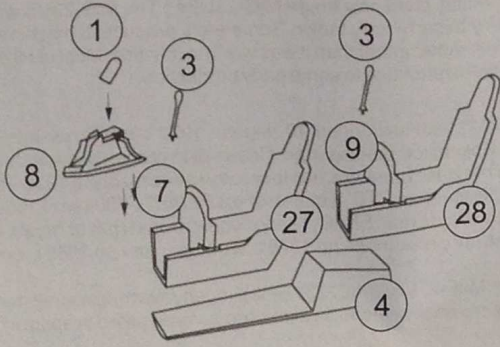

2

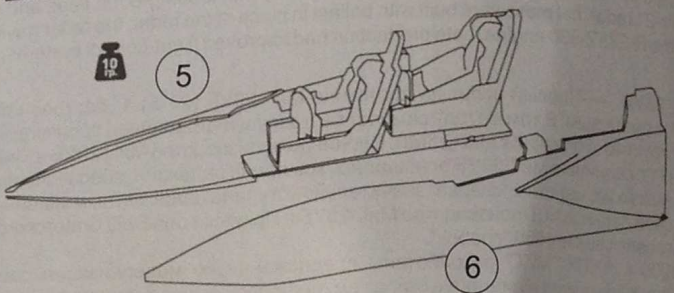

3

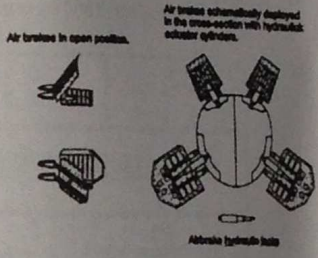
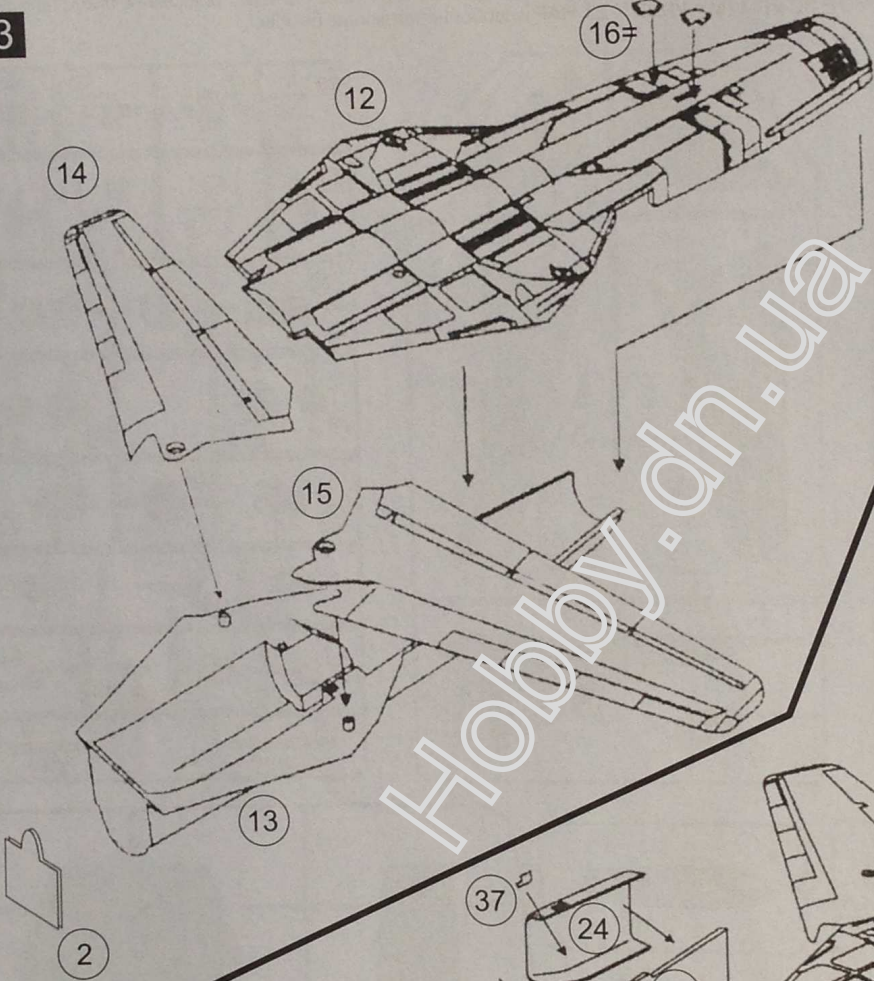

4

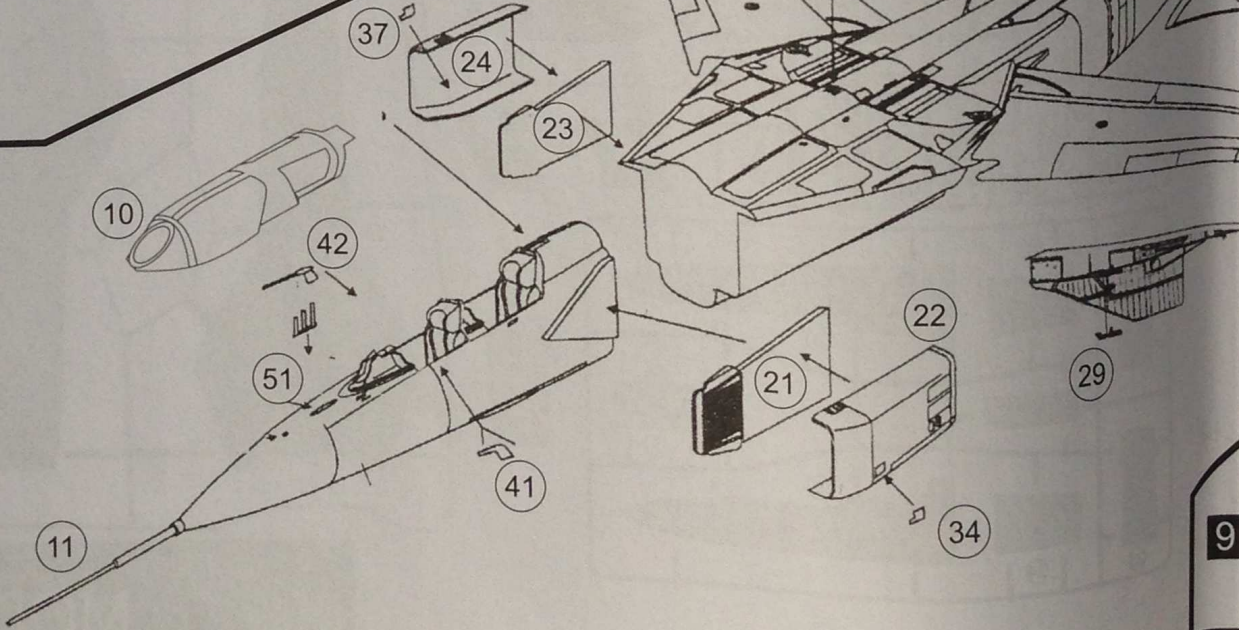

9

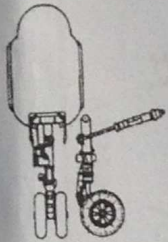

2 x KT-182
(820 x 125mm)

5

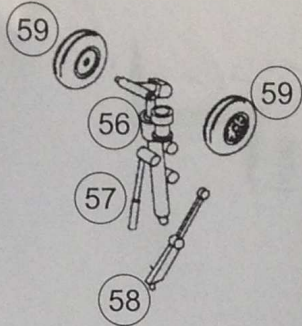

6

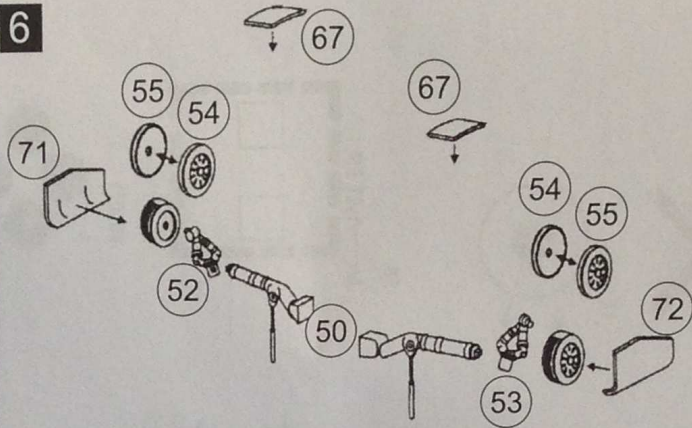

7

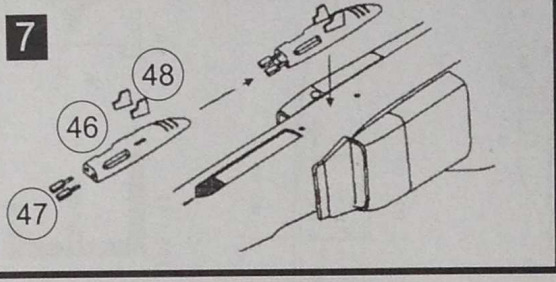

Main undercarriage

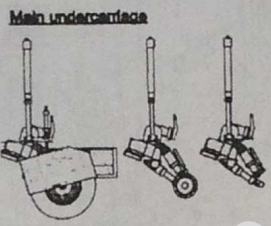
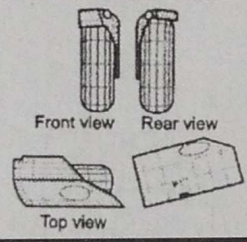
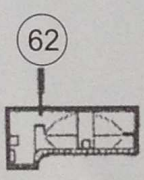

Main undercarriage

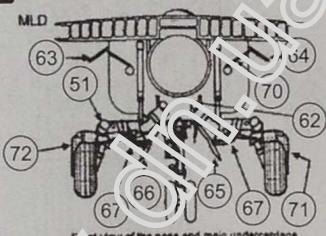

Front view of the nose and main undercarriage

8

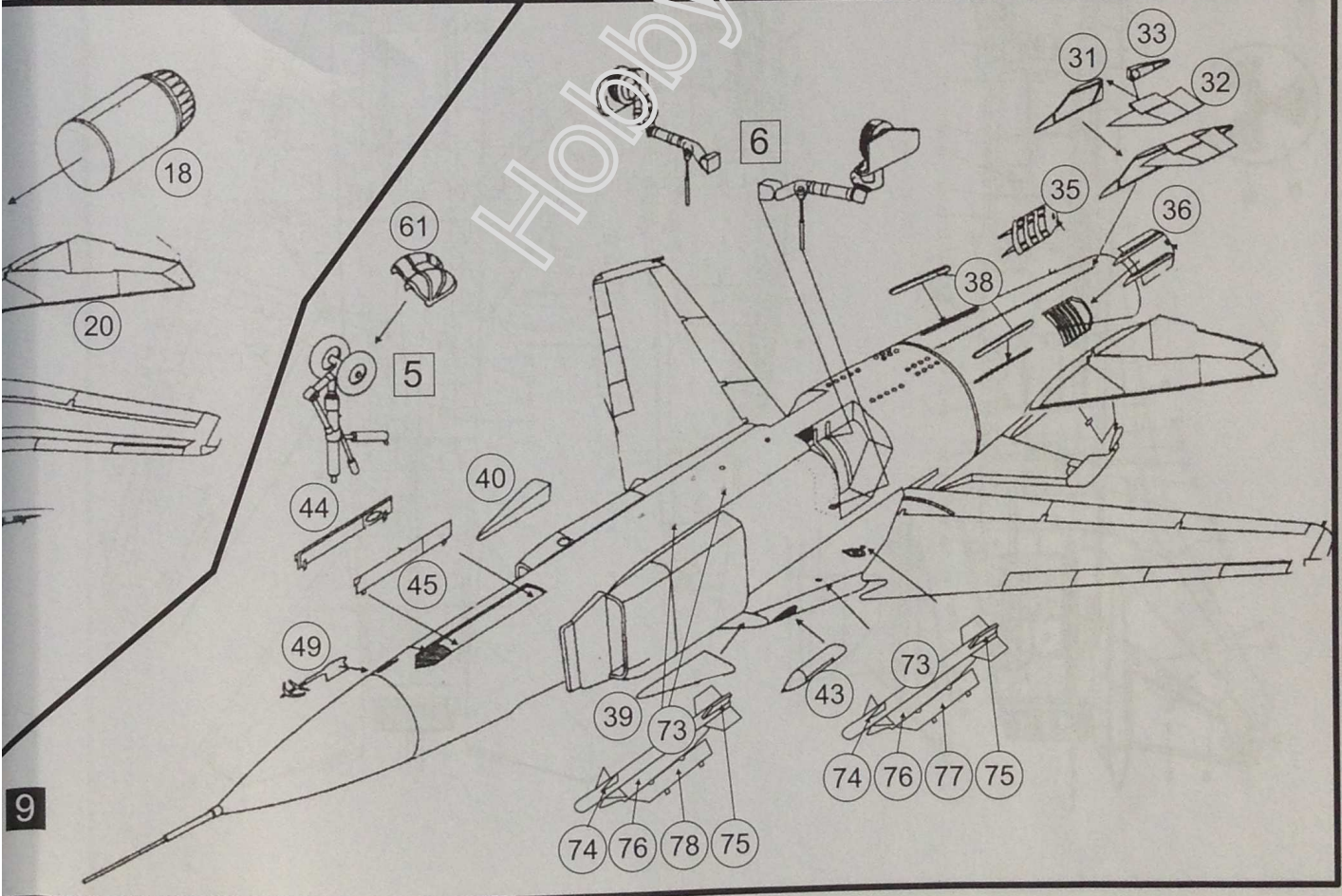
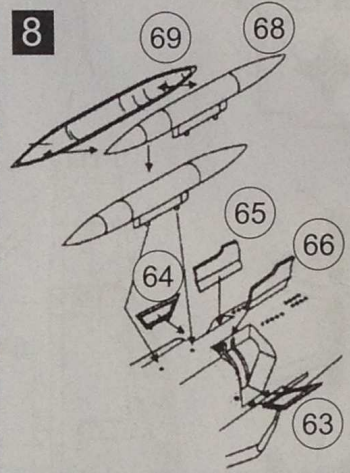

9

К

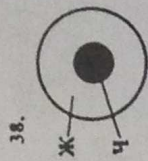

38.

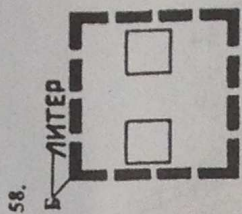

60.(Ч)

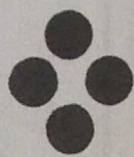

11.ОЖ

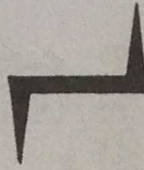

65.(К)

ПОДЪЕМ

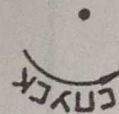

ЛАФЕТА

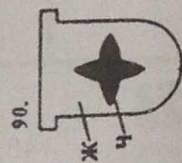

90.

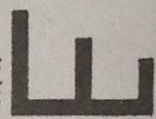

105.(Ч)

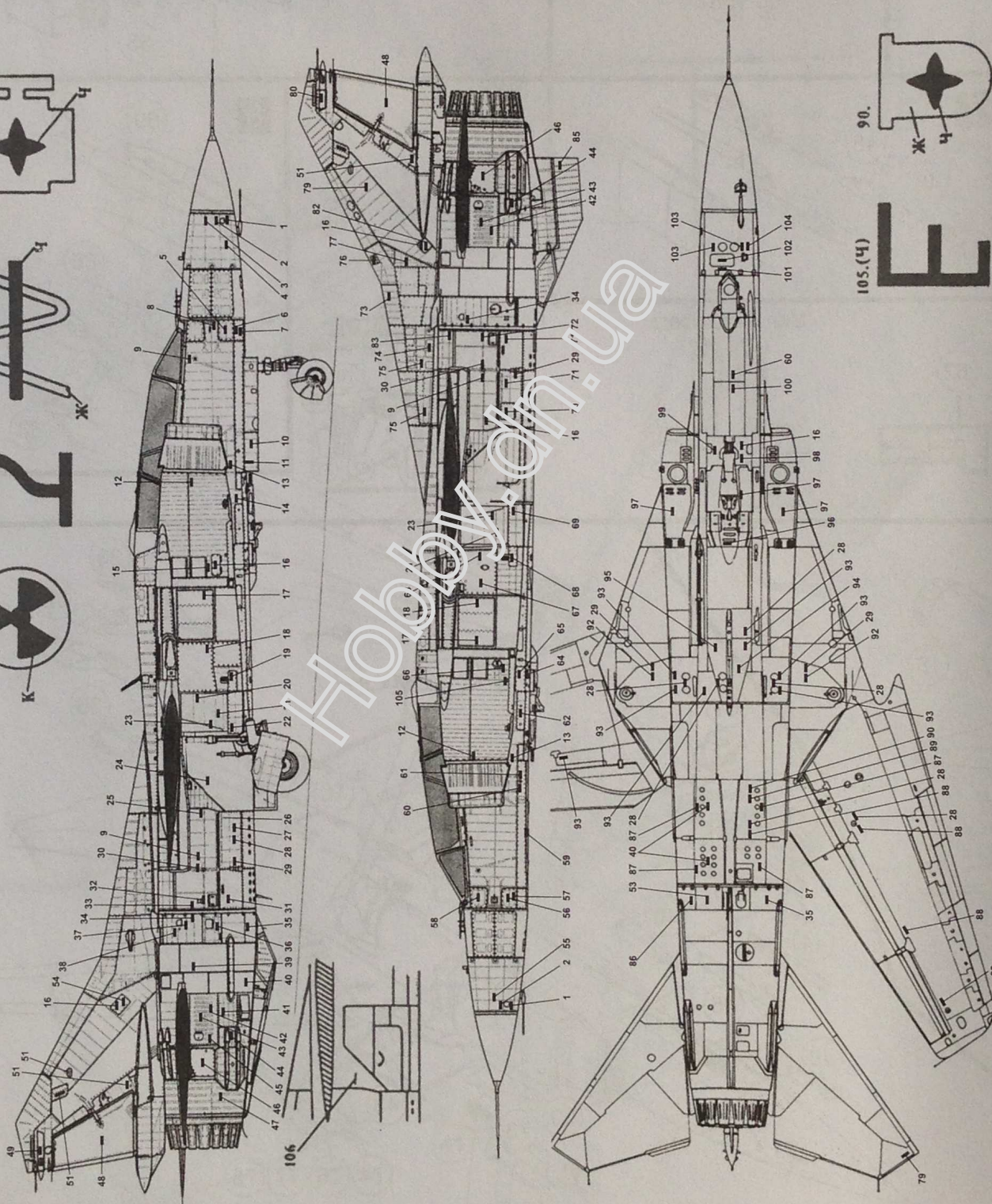
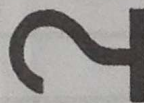
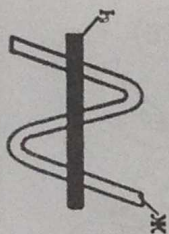
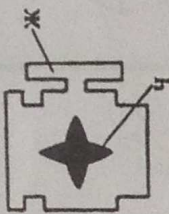

HobbyWorld.com.ua

CUBAN AIR FORCE

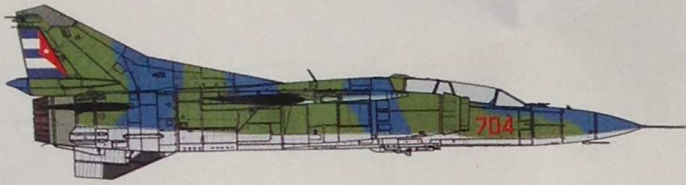
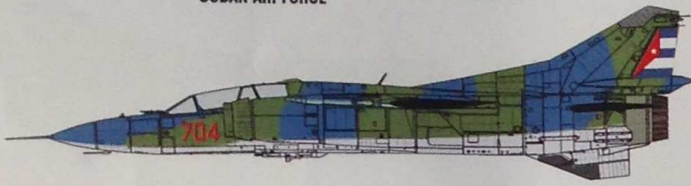

- Humbrol
- 48+14
 - 155
 - 127+34

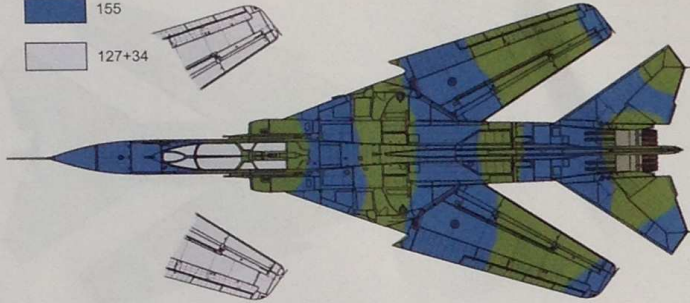

POLISH AIR FORCE - 28 FIGHTER REGIMENT

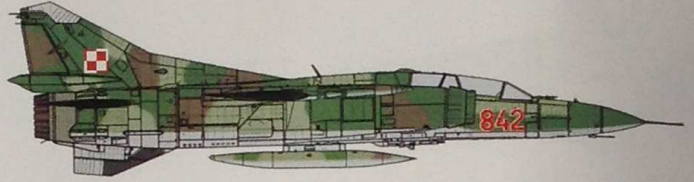
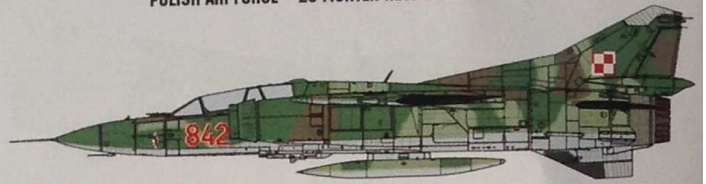

- Humbrol
- 78
 - 98
 - 149
 - 147+35

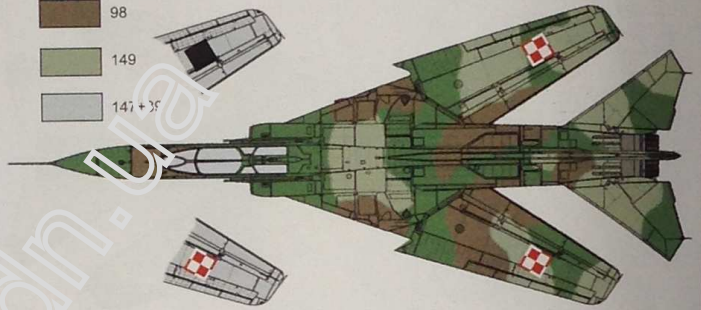

CZECH AIR FORCE - 41STL - RIAT97

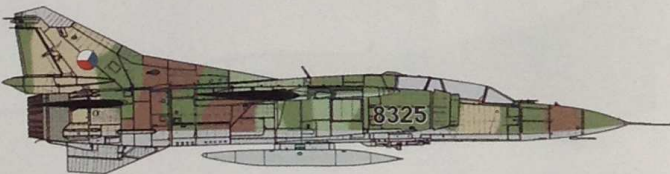

- Humbrol
- 107
 - 105
 - 120
 - 187
 - 147+89

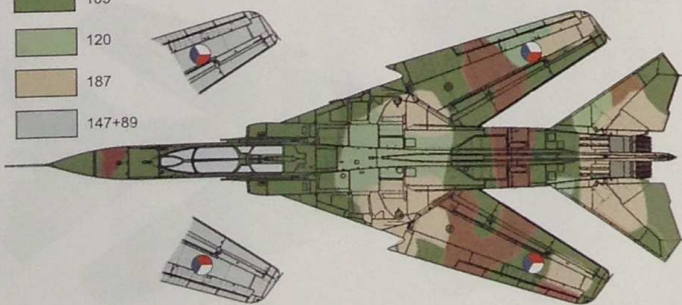

POLISH AIR FORCE - 28 FIGHTER REGIMENT

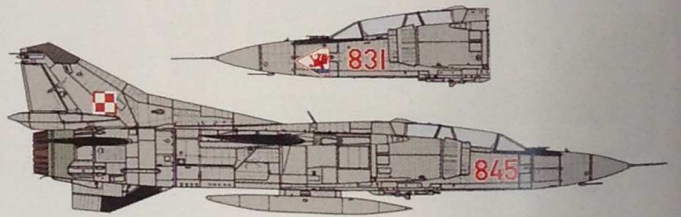
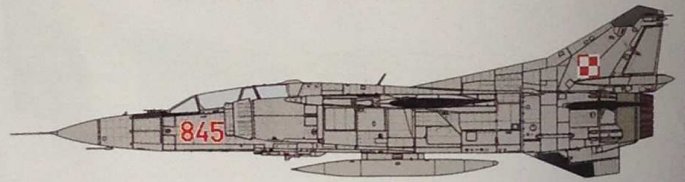

- Humbrol
- 127
 - 133
 - 156
 - 191

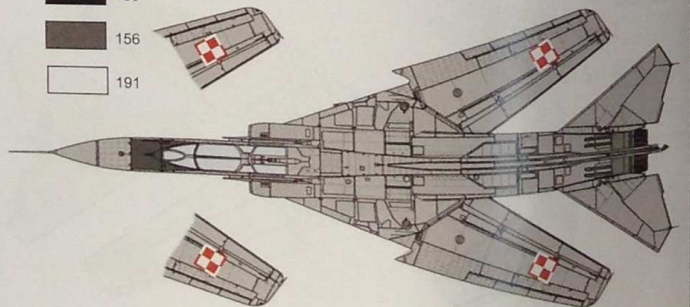

LIBIAN ARAB AIR FORCE

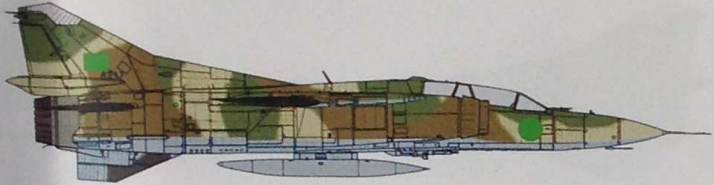
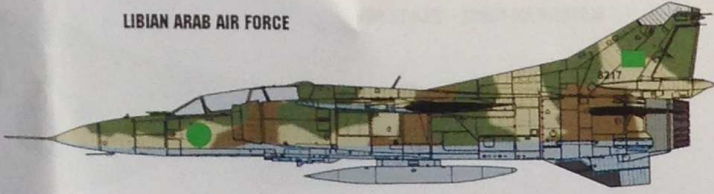

- Humbrol
- 121
 - 117
 - 186
 - 65+34

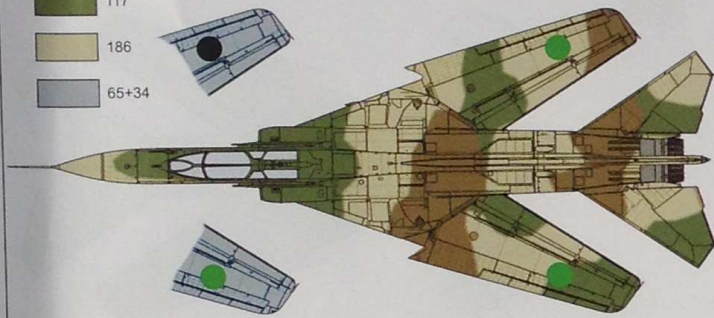

RUSSIAN AIR FORCE - FGUP CORPORATION S - MOSCOW 10.08.02

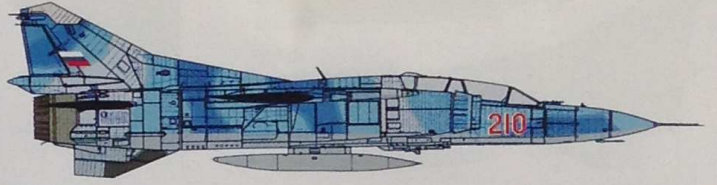

- Humbrol
- 47+34
 - 48+34
 - 48+190

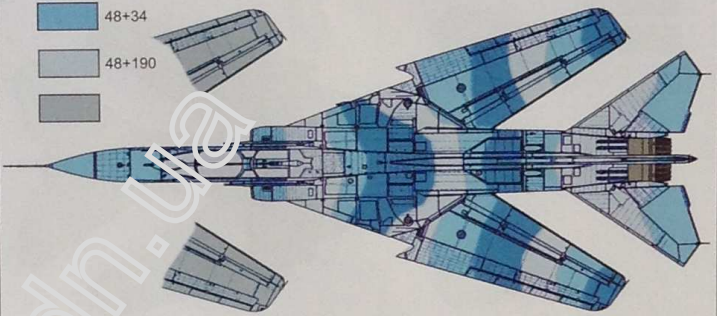

RUSSIAN AIR FORCE - 120 IAP. BAGRAM, NOVEMBER 1988.

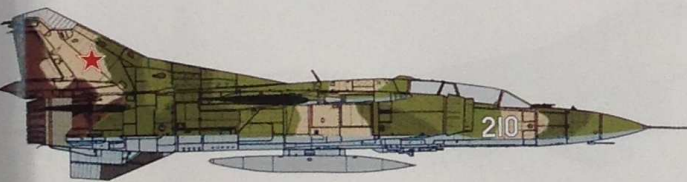
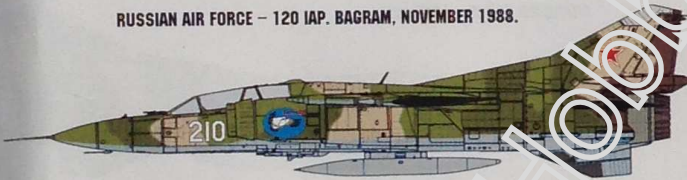

- Humbrol
- 147
 - 117
 - 105
 - 187
 - 147+89

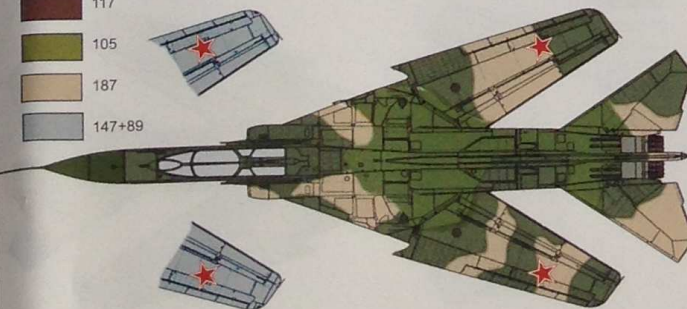

IRAG AIR FORCE - 84TH FS

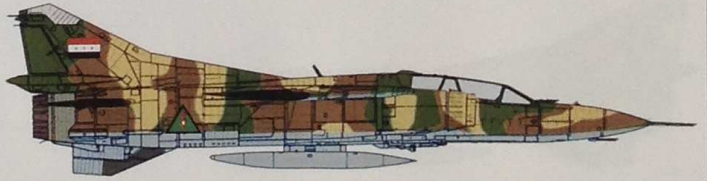
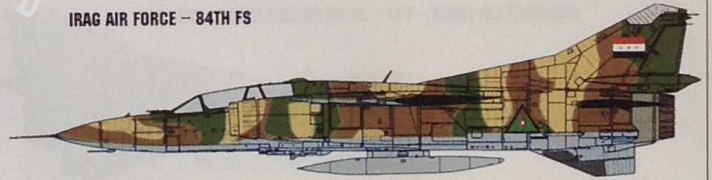

- Humbrol
- 147
 - 121
 - 187
 - 147+89

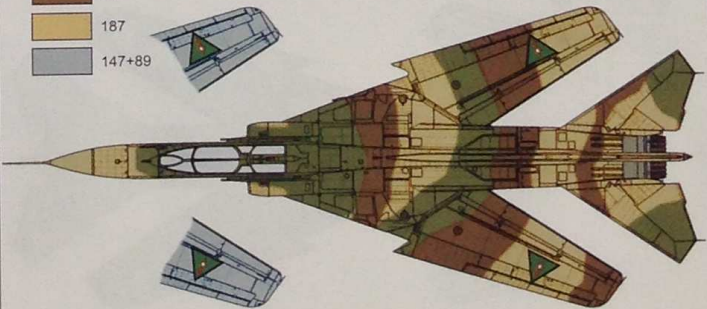

EAST GERMAN AIR FORCE - JBG-37

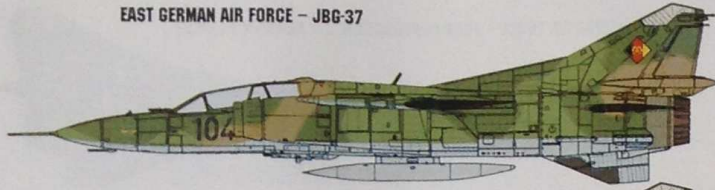

GERMAN AIR FORCE

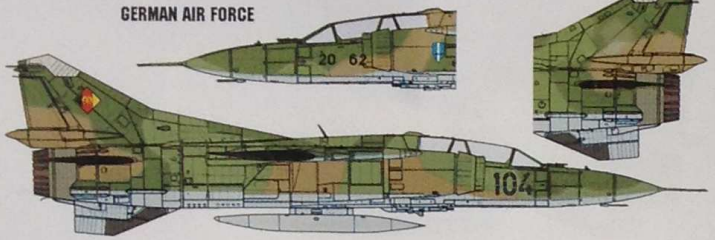

Humbrol

- 84
- 105
- 75
- 65+34

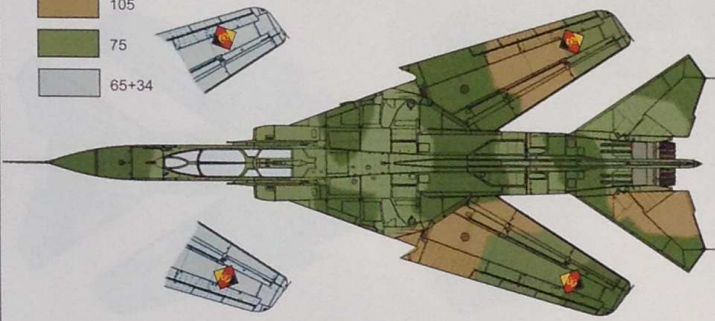

ALGERIAN AIR FORCE - 28/9TH SGN

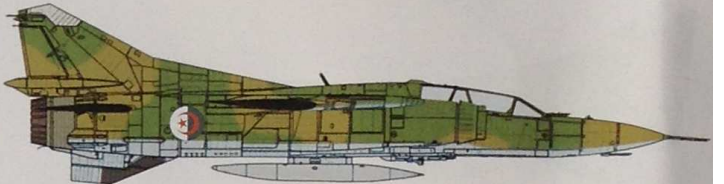
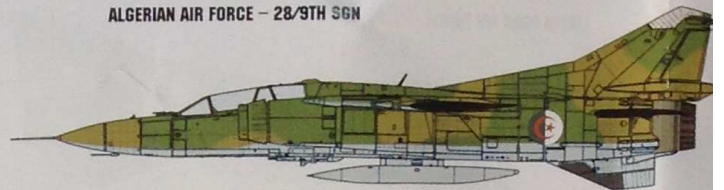

Humbrol

- 19
- 116
- 147+89

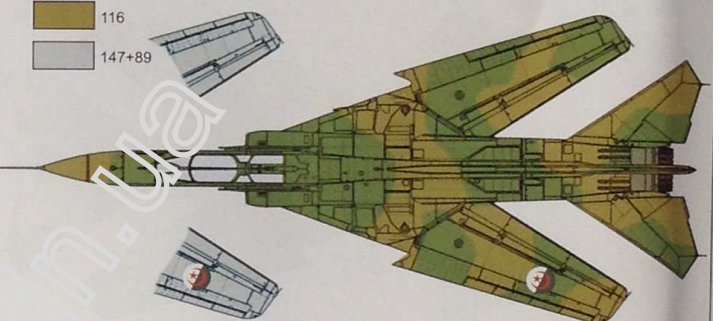

ROMANIAN AIR FORCE - 1ST - 93 RD FIGHTER-BOMBER AIR BASE

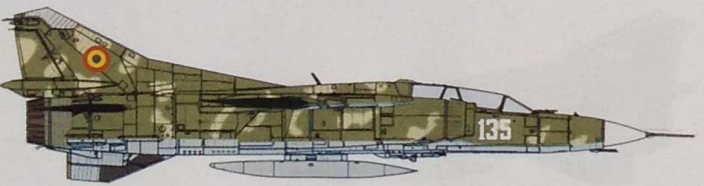

Humbrol

- 98+149
- 121+91
- 47+34
- 34

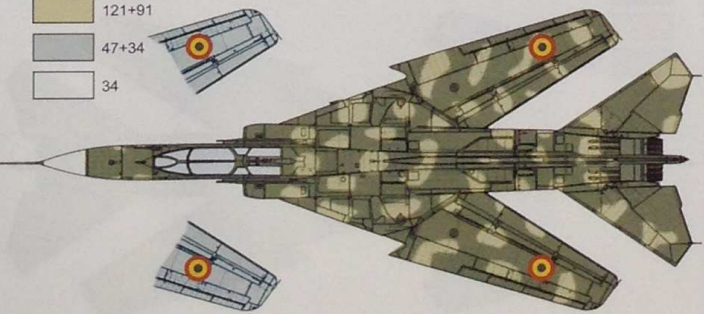

INDIAN AIR FORCE - 10TH SGN

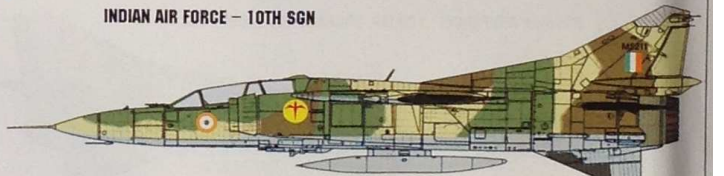

Humbrol

- 103
- 86
- 98
- 146

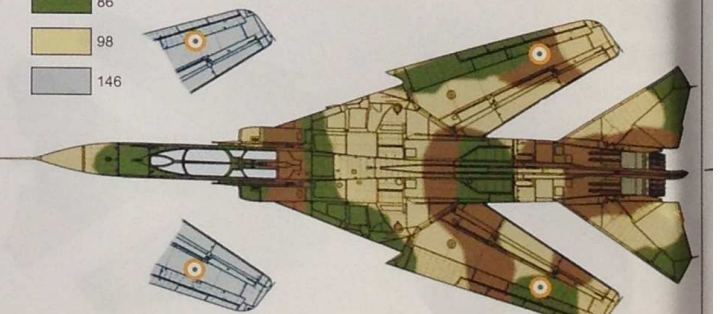

ANGOLAN AIR FORCE

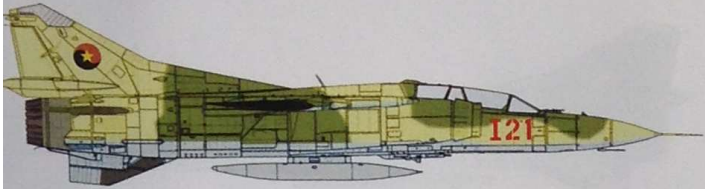
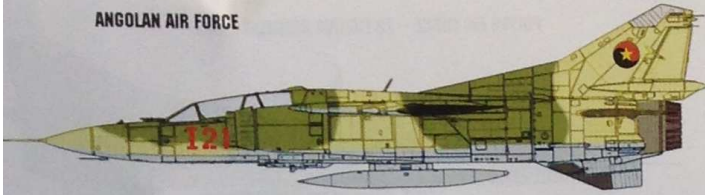

- Humbrol
- 103
 - 116
 - 147+89

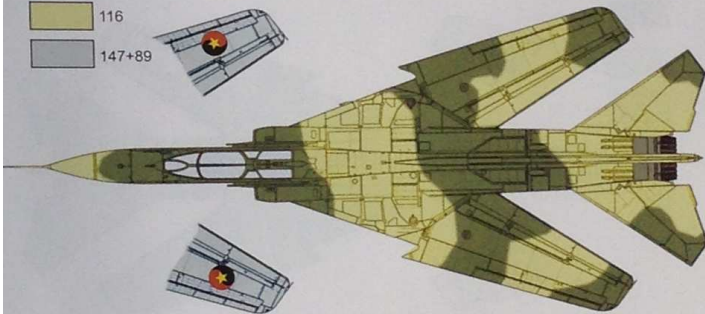

HUNGARIAN AIR FORCE - 47TH PTFR

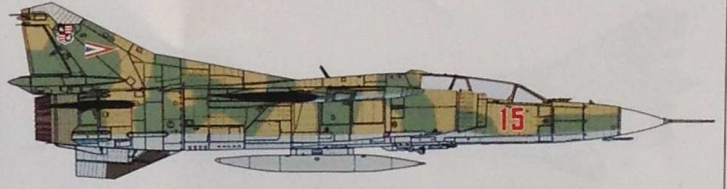
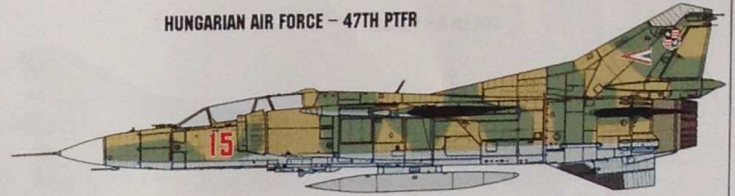

- Humbrol
- 84+34
 - 115
 - 65+34
 - 34

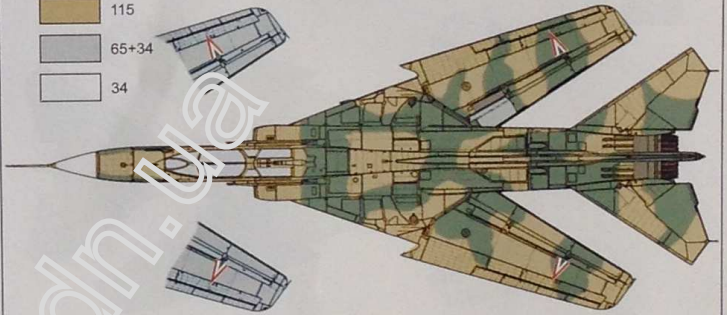

ETHIOPIAN AIR FORCE

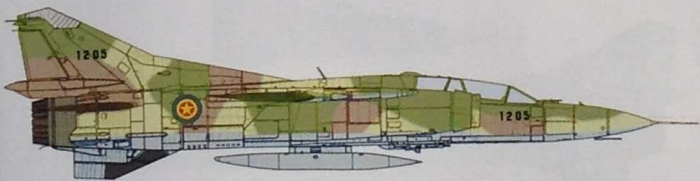
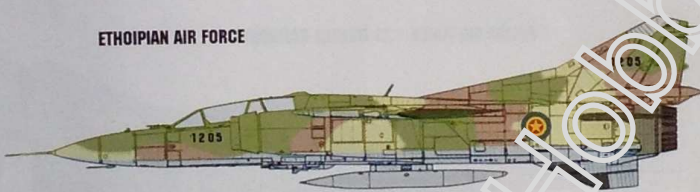

- Humbrol
- 121
 - 120
 - 186+34
 - 174+89

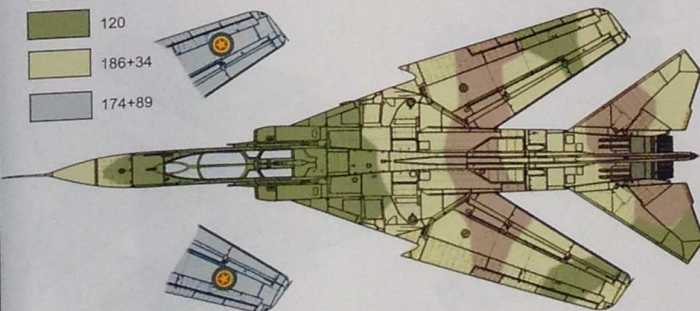

UKRAINE AIR FORCE

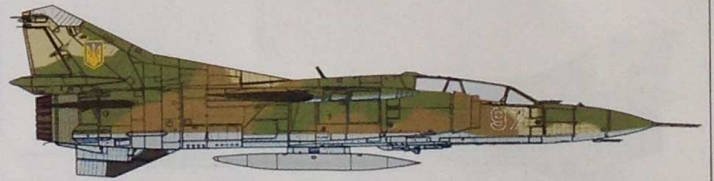
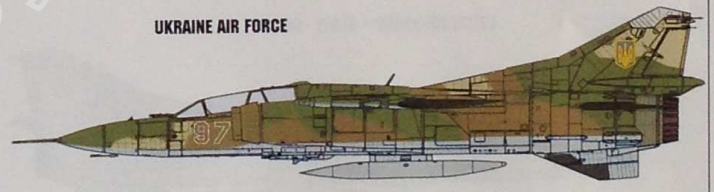

- Humbrol
- 105
 - 107
 - 120
 - 115

