

CAT.NO.BX48002 PLASTIC MODEL KITS / LIMITED EDITION

SCALE:1/48

- UA Zerbe Air Sedan був американським проектом одномоторного пасажирського літака, збудованим професором Джеймсом Слау Зербе у 1918 році. Літак пілотував Том Фленнері під час свого першого та єдиного польоту у 1919 році. Air Sedan злетів і швидко набрав висоту 100 футів (30 м), пролетів приблизно 1000 футів (300 м), потім був значно пошкоджений при посадці.
- GB The Zerbe Air Sedan was an American single engine quadruplane passenger aircraft project started by Professor James Slough Zerbe in 1918. The Air Sedan was piloted by Tom Flannery on its first and only flight in 1919 at the Washington County Fairgrounds in Fayetteville, Arkansas. The aircraft took off and quickly climbed to 100 ft (30 m), flew approximately 1000 ft (300 m) then was significantly damaged during landing.

Декалі для одного варіанта  
Decals for one version

**ZERBE** AIR SEDAN. **ZERBE** AIR SEDAN. ZERBE AVIS BX48002

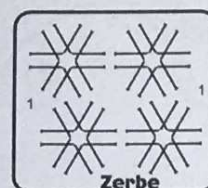

P

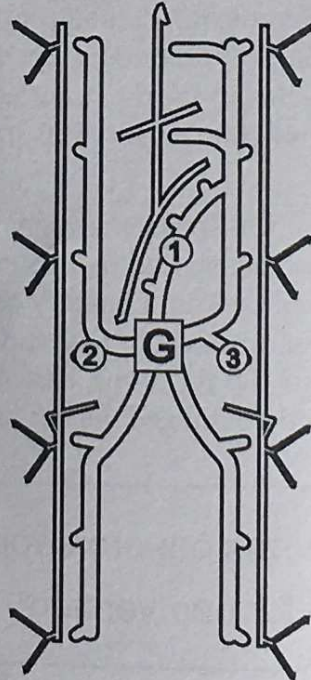
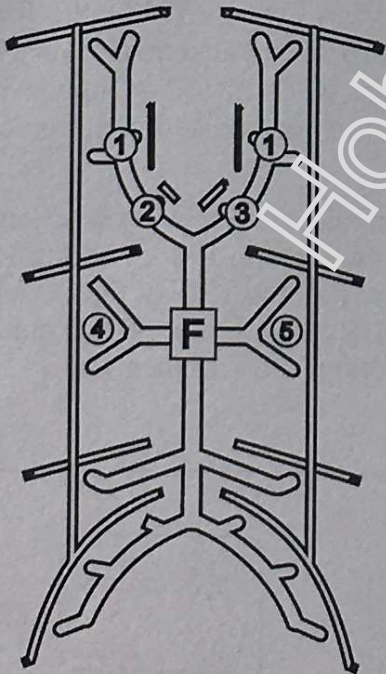
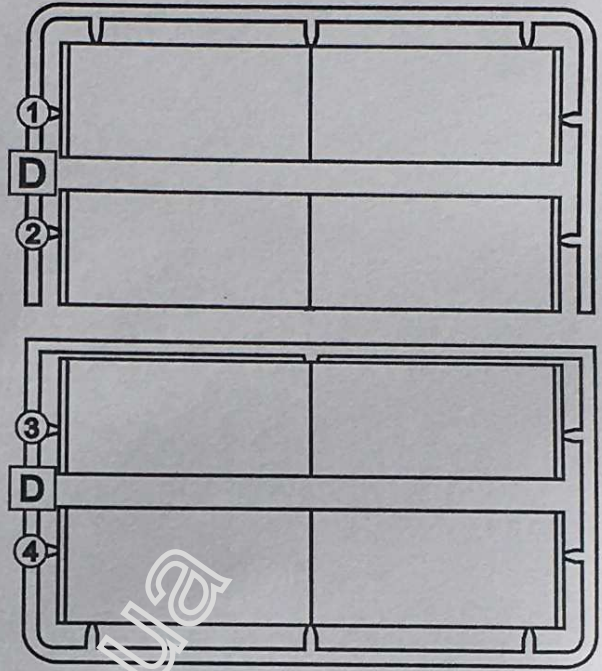
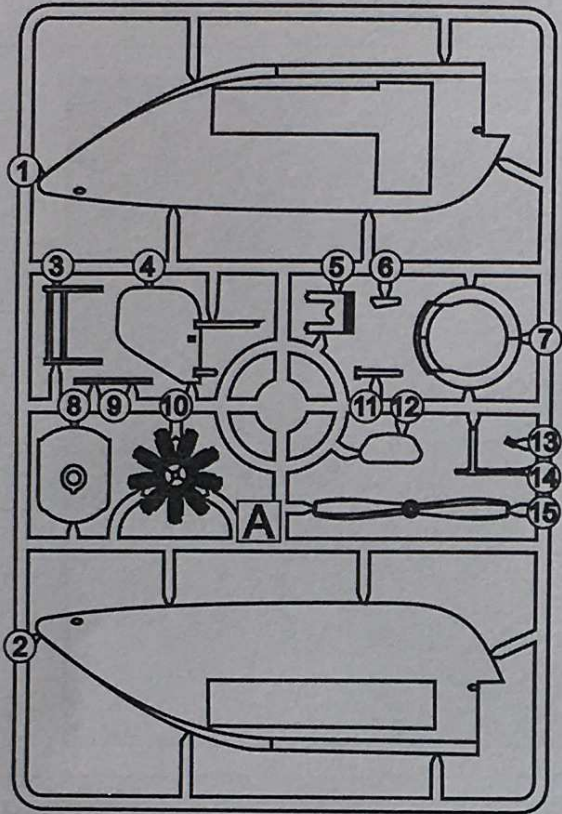

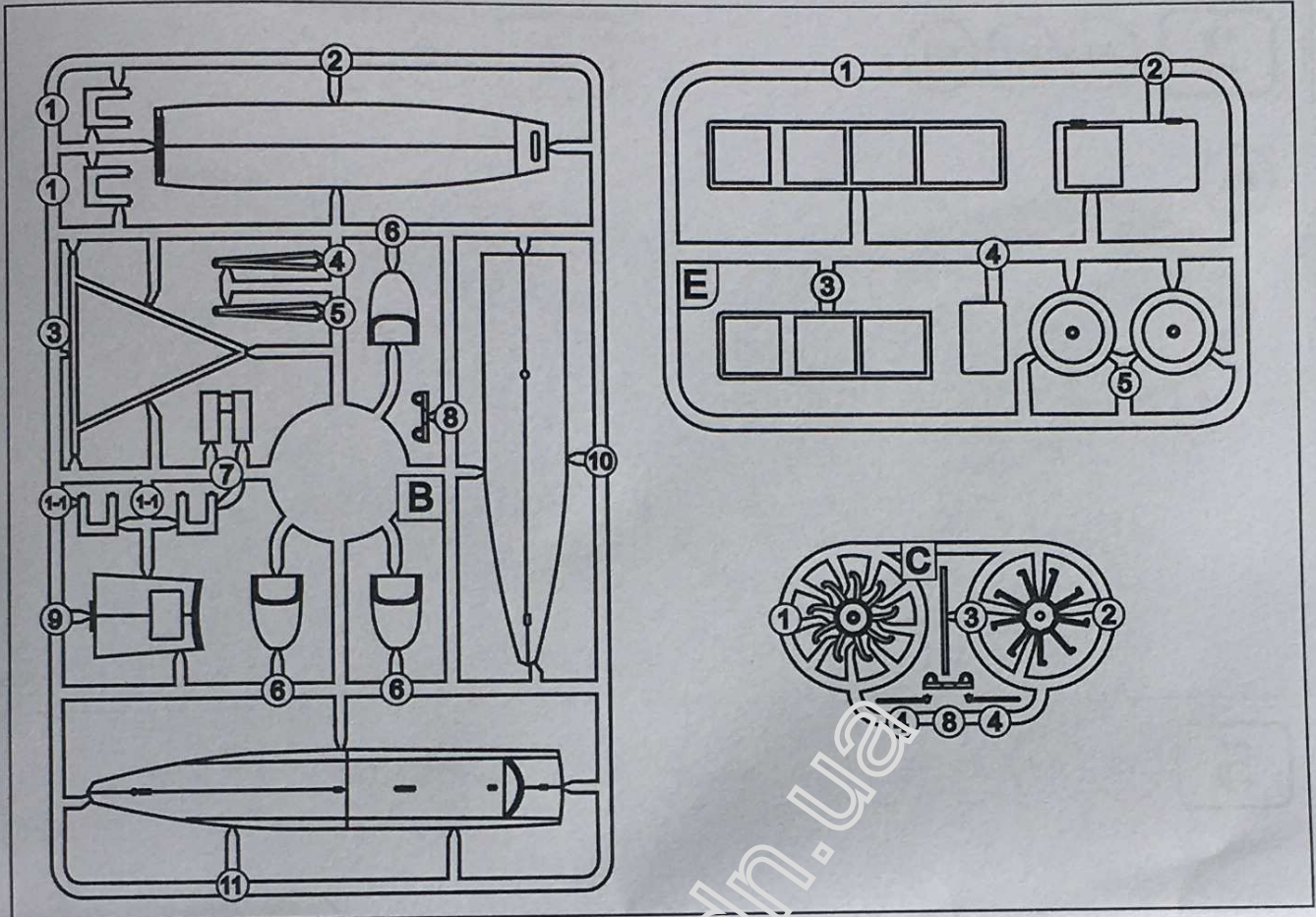

1 ЕТАПИ СКЛАДАННЯ  
STAGES OF  
ASSEMBLY



2X КІЛЬКІСТЬ  
ОПЕРАЦІЙ(ДЕТАЛЕЙ)  
QUANTITY OF  
OPERATIONS(PARTS)



1 НОМЕР ДЕТАЛІ  
NUMBER  
PARTS



A8 ФАРБУВАТИ  
TO PAINT



КЛЕЇТИ  
GLUE



НЕ КЛЕЇТИ  
DON'T  
GLUE



НЕ КЛЕЇТИ  
DON'T  
GLUE



1 НАНЕСТИ  
ДЕКАЛЬ  
APPLY DECALS



! ВИГОТОВИТИ  
ДЕТАЛЬ  
TO MAKE A DETAIL



УСУНУТИ НОЖЕМ  
DETACH WITH  
KNIFE



ЗІГНУТИ  
TO BEND



ВИКОНАТИ  
ОТВІР  
MAKE A HOLE

**1**

A7

A10

A11

A15

**2**

A8

A12

A11

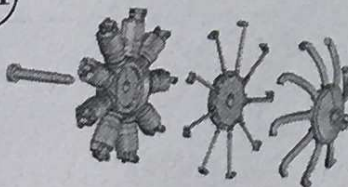

C1

A7

A10

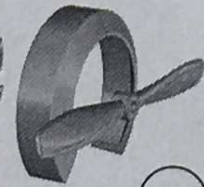

A15

C2

A8

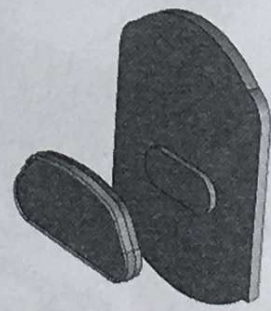

A12

3

A1

E2

E3

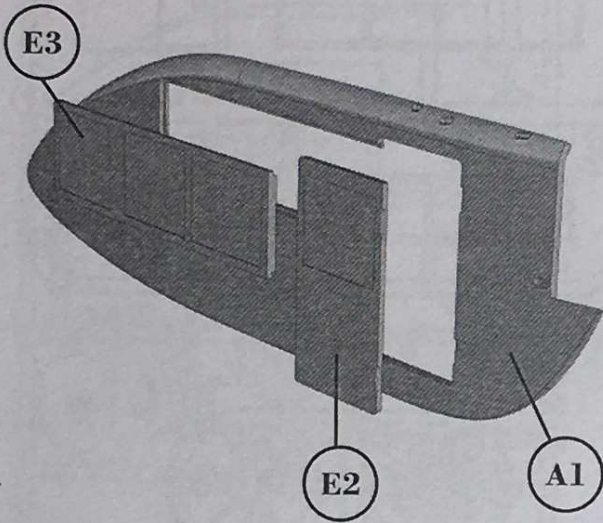

4

A2

E1

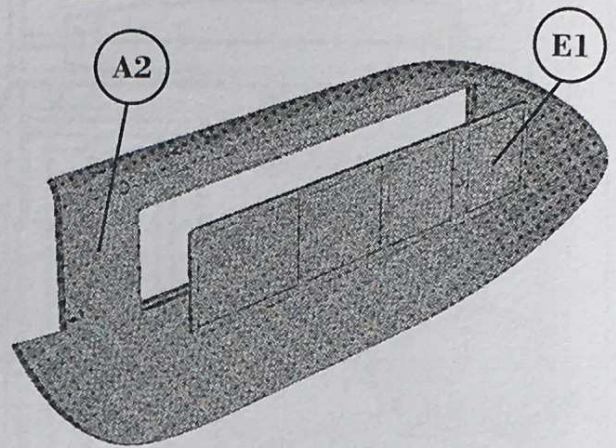

5

A3

A5

A9

A14

B1

B1-1

B6

B7

B8

B10

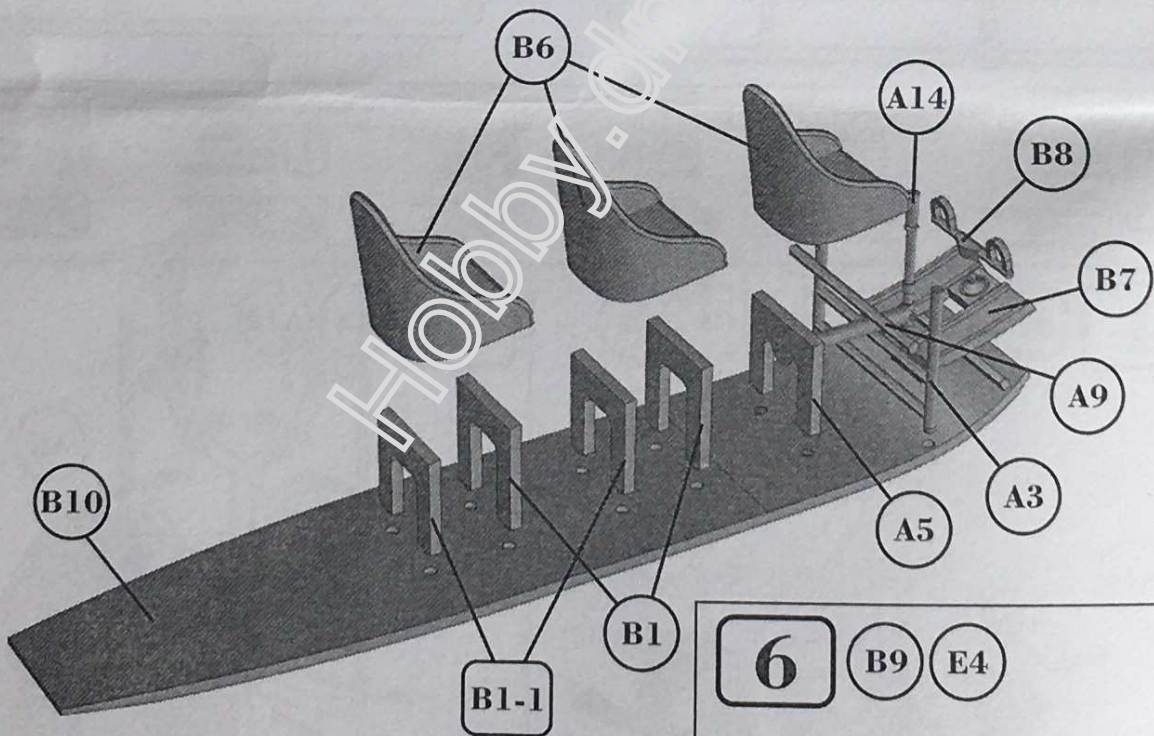

6

B9

E4

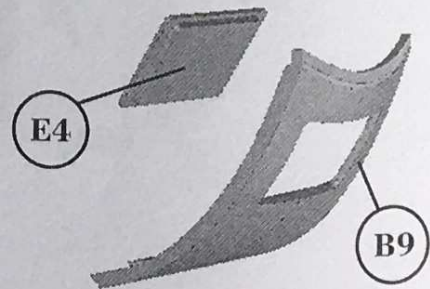

7

2

+

4

+

5

+

6

B2

B11

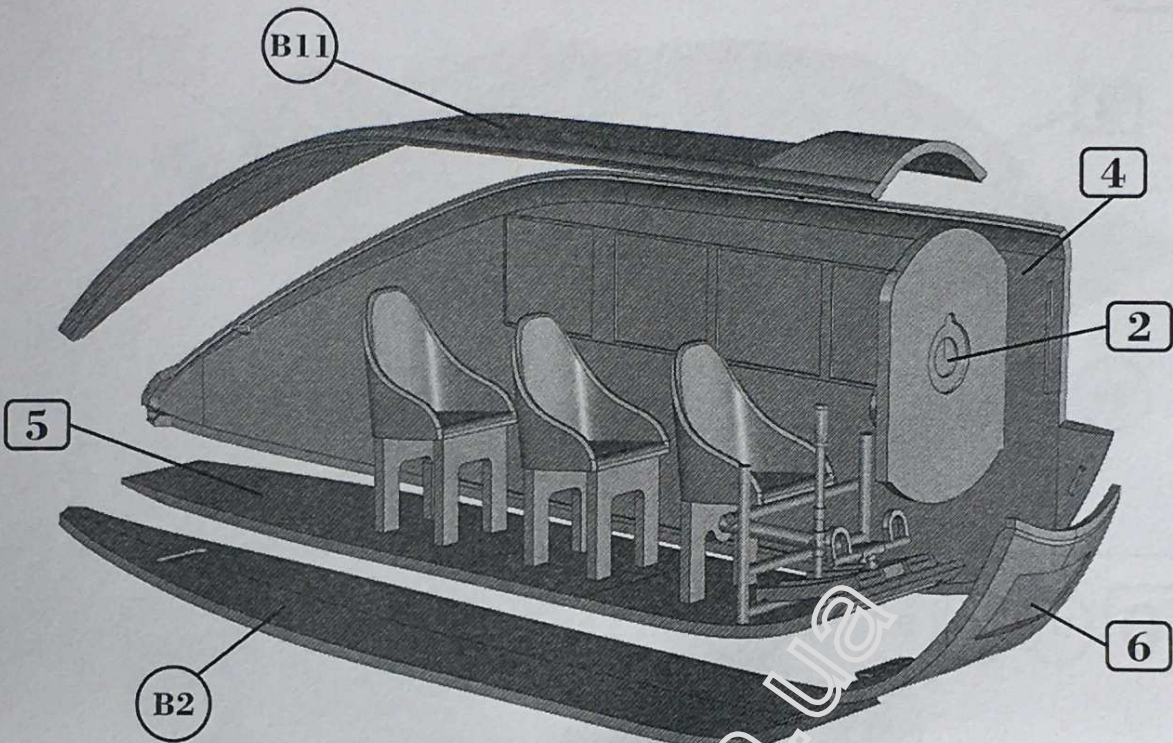

8

3

+

7

B3

B4

B5

E5

P1

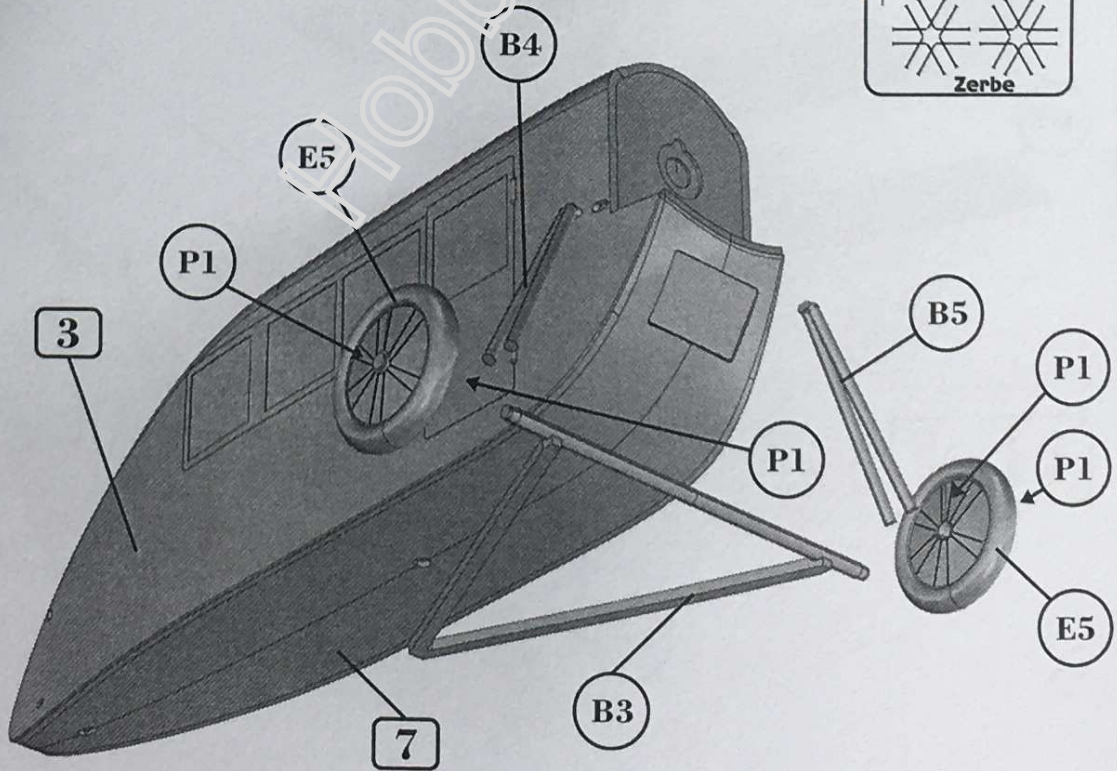
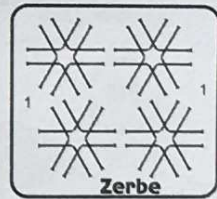

**9** **8** + **1**

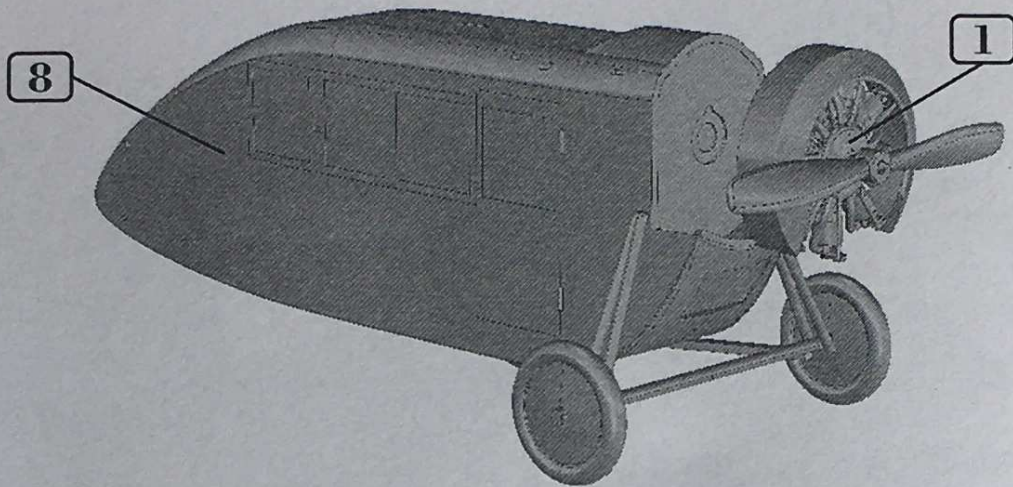

**10** **D1** **D2** **D3** **D4** **G2** **G3**

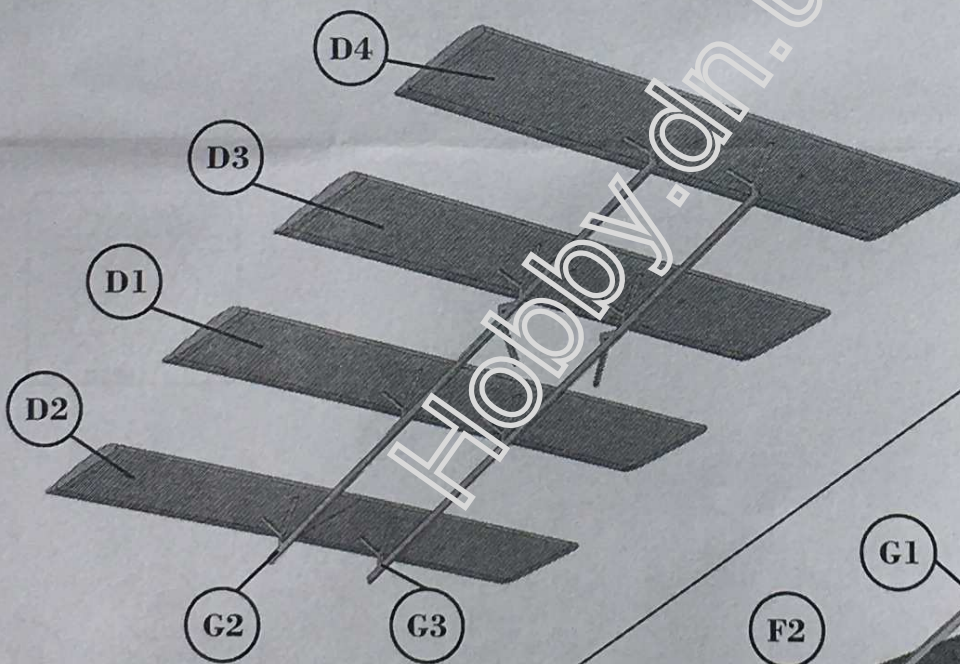

**11** **9** **A6** **C3** **F2** **F3** **G1**

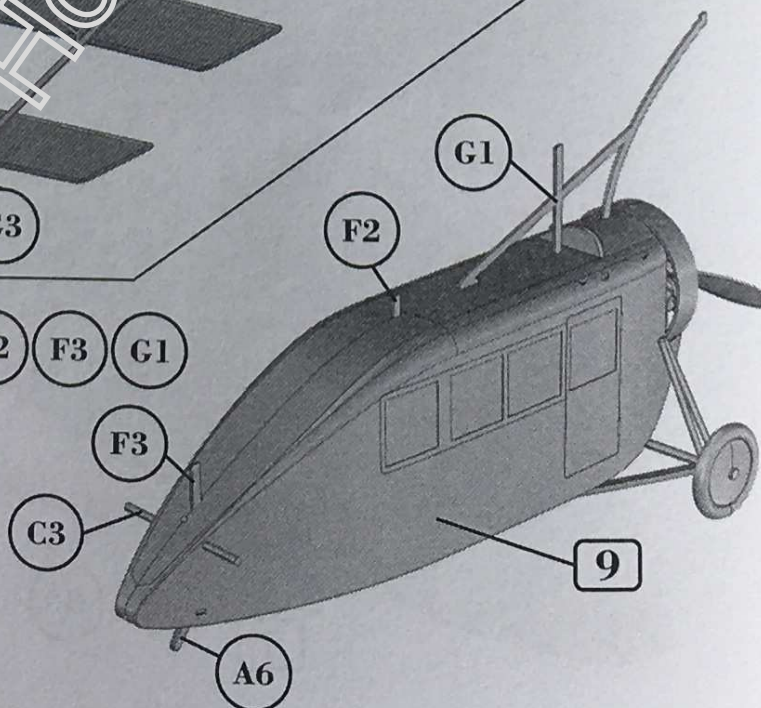

**12** **10**+**11** **F4** **F5** **B5** **E5**

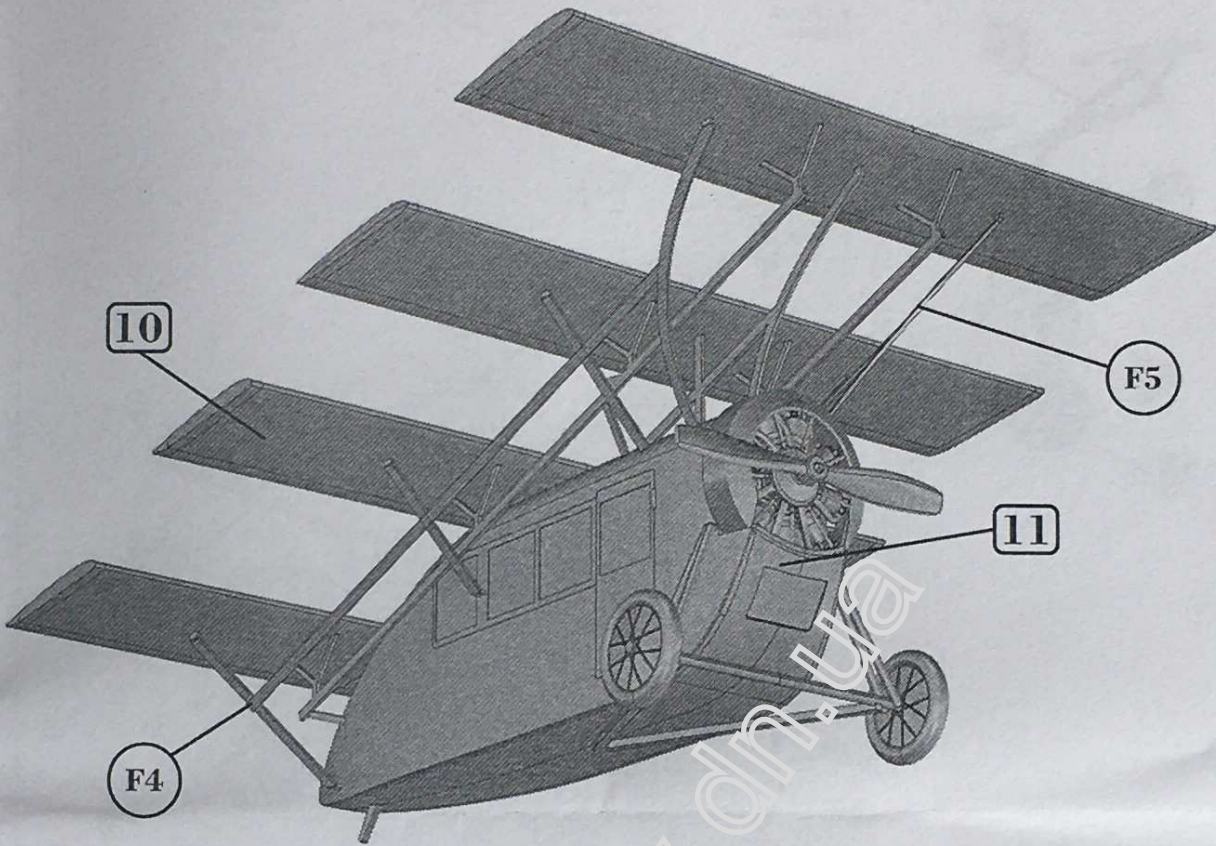

**13** **12** **A4** **F1**

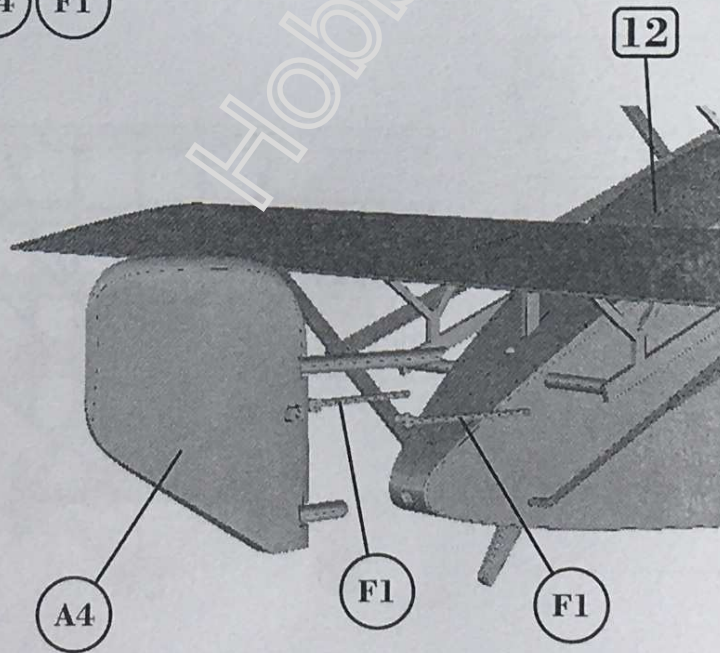

- |          |   |          |   |          |   |          |   |
|----------|---|----------|---|----------|---|----------|---|
| <b>A</b> |  | <b>B</b> |  | <b>C</b> |  | <b>D</b> |  |
|          | КРЕМОВИЙ<br>CREAM   |          | ЧОРНИЙ<br>BLACK   |          | ДЕРЕВО<br>NATURAL WOOD  |          | РЕЗИНА<br>RUBBER  |

