

UTI MiG-15

eduard

SOVIET JET TRAINER AND LIGHT ATTACK AIRCRAFT

1/144 SCALE PLASTIC KIT

DUAL COMBO! #4444



INTRO

MiG-15 fighter aircraft has become one of the post-WW2 aircraft development symbols, especially the one of the communist block lead by Soviet Union. It played crucial role in the Korean War, took part of the Suez Crisis as well as in other less important conflicts in Asia, Africa, Caribbean etc. The key part of the aircraft – the engine and the swept wing – were not developed in Soviet Union but in other countries. The swept wing was elaborated by German researchers and found its way to Soviet Union as a part of the war prize. The engine, under licence built Rolls Royce Nene, was created by British engineers. The specifications that led to the MiG-15 birth were issued in 1947. Temporary Soviet attempts to develop their own jet engine failed and captured German Jumo 004 and BMW 003 jet engines became obsolete. Under such a situation Soviet Union decided to buy few tens of British Nene I, Nene II and Derwent V engines. The licence to built these engines was built also. Three type of the fighter airplanes were built using these engines. The Derwent was the heart of Yak-23 with straight wing and Nene found its way to Lavochkin 168 and MiG-15, both with the swept wing and horizontal stabilizator. Soviets believed that at least one of two different wing designs will fulfill the requirements. Finally Yak-23 and MiG-15 entered the serial production but only the latter became world-wide known thanks to its performance and high numbers of airplanes manufactured. The first prototype under I-301 designation was finished on December 19th and made its maiden flight on December 30th, 1947. The second prototype powered by more powerful Nene II engine flew for the first time on May 27th, 1948. The third prototype joined previous two ones afterwards but test flight were so satisfying that serial production of the aircraft under designation MiG-15 was ordered on July 17th, 1948. The first production aircraft was assembled in June 1949 and the serial production was step by step launched in many facilities across the Soviet Union. The production MiG-15 was powered by RD-45F engine and armed with two 23 mm cannons NS-23KM and one 37 mm cannon N-37. The various bombs and unguided air-to-ground missiles (LR-130 and S-21) could be attached to the hardpoints on the wing undersurface. A bit later, in 1950 – 1951 the production of MiG-15bis begun. Powered by VK-1 engine with the higher output these were easily recognizable thanks to the modified aerial brakes on the tail. The „bises“ were produced till 1953 when the MiG-17 replaced them on the assembly lines. The Fifteens were manufactured outside the Soviet Union. The Aero and Let facilities in Czechoslovakia and PZL Mielec in Poland built them in relatively high numbers. The twoseaters were built by Chinese also. Apart of the fighters more variants were built. The twoseater UTI MiG-15 was flown as a training aircraft. The majority of them left the production line in Czechoslovakia. In Czechoslovakia many MiG-15s and bises were underwent the modification to the fighter-bomber MiG-15SB and MiG-15bisSB version with four underwing pylons. The MiG-15R / MiG-15bisR was the recon version with cameras and MiG-15T served as a target-towing aircraft. The Fifteens were given with the NATO code designation. The singleseaters were coded Fagot A for MiG-15 and Fagot B for MiG-15bis. The twoseater UTI MiG-15 was known under the codename Midget.

ATTENTION



UPOZORNĚNÍ



ACHTUNG



ATTENTION



注意



Carefully read instruction sheet before assembling. When you use glue or paint, do not use near open flame and use in well ventilated room. Keep out of reach of small children. Children must not be allowed to suck any part, or pull vinyl bag over the head.



Před započítím stavby si pečlivě prostudujte stavební návod. Při používání barev a lepidel pracujte v dobře větrané místnosti. Lepidla ani barvy nepoužívejte v blízkosti otevřeného ohně. Model není určen malým dětem, mohlo by dojít k požití drobných dílů.

INSTRUCTION SIGNS



INSTR. SYMBOLY



INSTRUKTION SINNBILDEN



SYMBLES



記号の説明

OPTIONAL
VOLBABEND
OHNOUTOPEN HOLE
VYVRTAT OTVORSYMETRICAL ASSEMBLY
SYMETRICKÁ MONTÁŽREMOVE
ODRŽNOUTREVERSE SIDE
OTOČITAPPLY EDUARD MASK
AND PAINT
POUŽIT EDUARD MASK
NABARVIT

PARTS



DÍLY



TEILE



PIÈCES



部品

PLASTIC PARTS

B> 2 pcs.

4440B

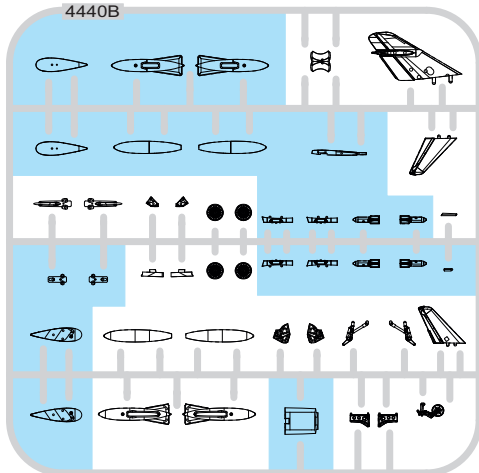

E> 2 pcs. F> 2 pcs.

4440F

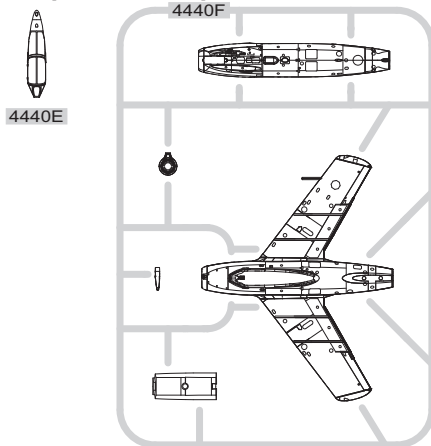
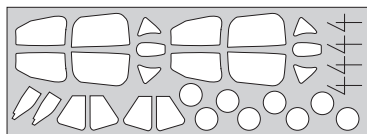
eduard
MASK

-Parts not for use. -Teile werden nicht verwendet. -Pièces à ne pas utiliser. -Tyto díly nepoužívejte při stavbě. - 使用しない部品

COLOURS



BARVY



FARBEN



PEINTURE



色

GSI Creas (GUNZE)		
AQUEOUS	Mr.COLOR	
H3	C3	RED
H12	C33	FLAT BLACK
H15	C65	BRIGHT BLUE
H25	C34	SKY BLUE
H26	C66	BRIGHT GREEN
H29	C44	TAN
H35	C32	LIGHT BLUE
H72	C22	DARK EARTH
H77	C137	TIRE BLACK

AQUEOUS	Mr.COLOR	
H80	C54	KHAKI GREEN
H302	C302	GREEN
H308	C308	GRAY
Mr.METAL COLOR		
MC14		DARK IRON
Mr.COLOR SUPER METALLIC		
SM01		SUPER FINE SILVER
SM04		SUPER STAINLESS
SM05		CHROME SILVER

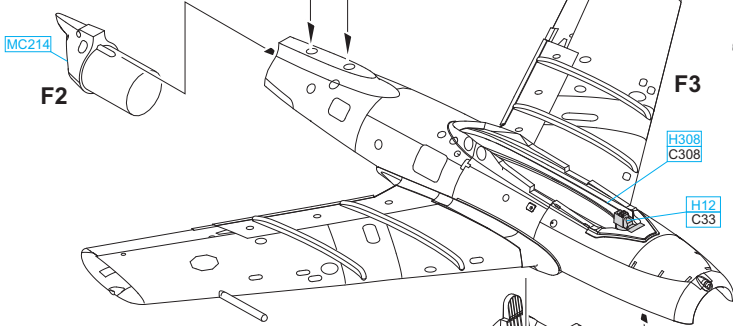
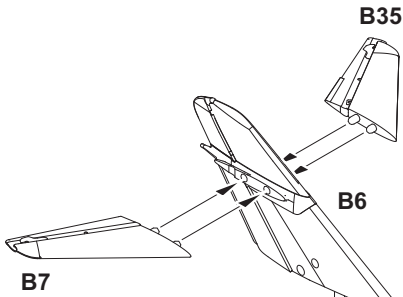
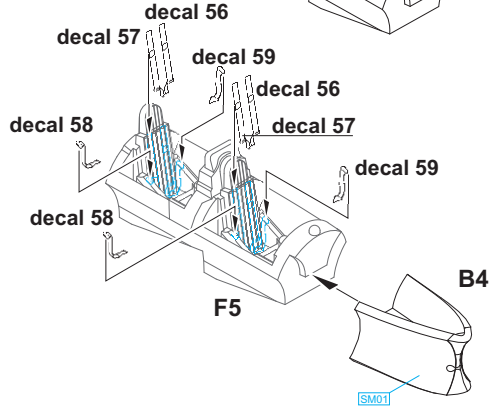
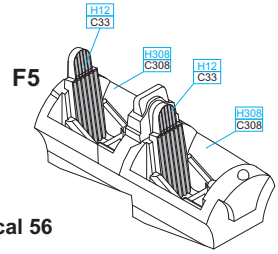
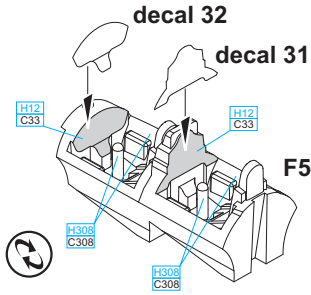
A

Don't forget
to add the nose
weight balance!

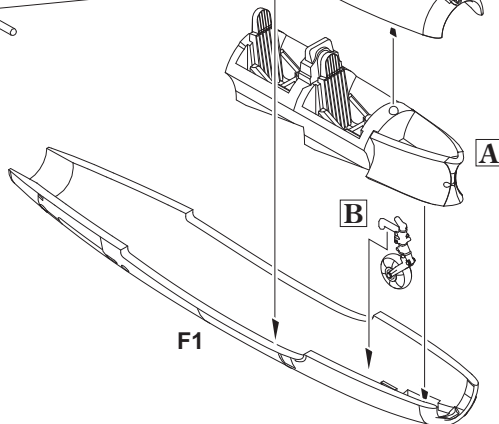
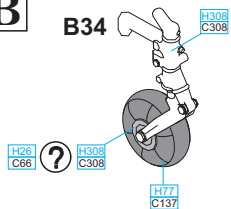
B

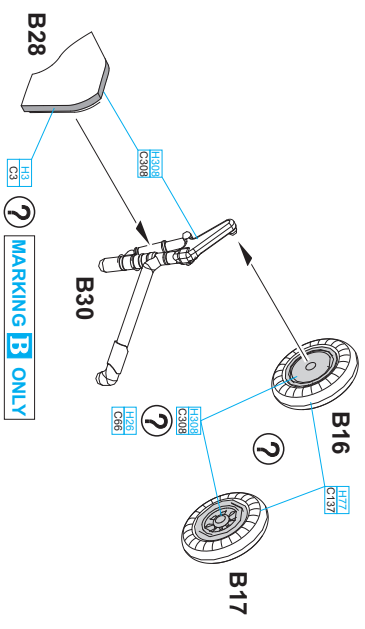
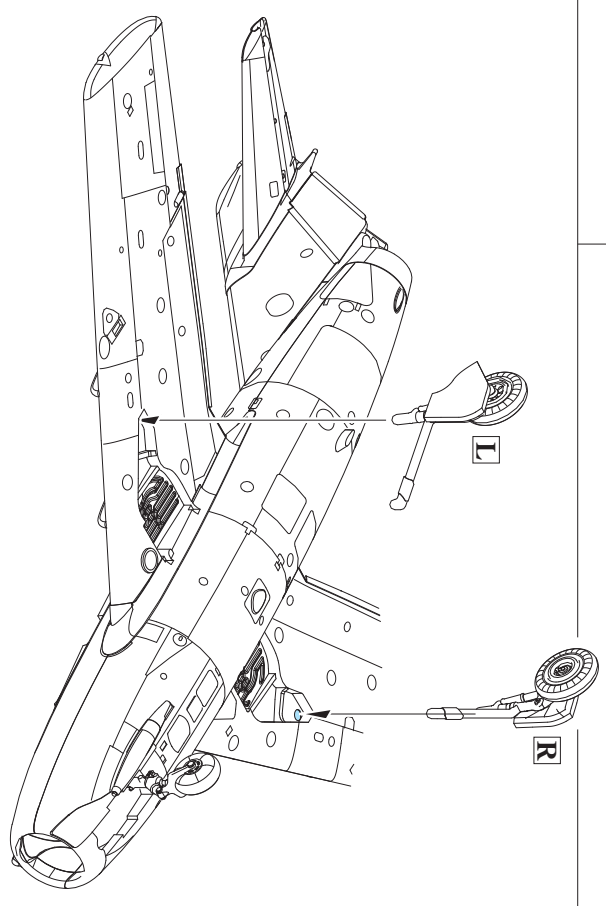
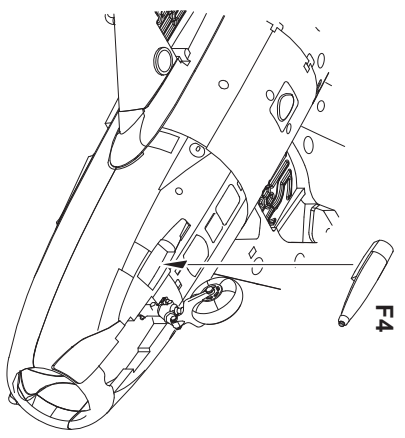
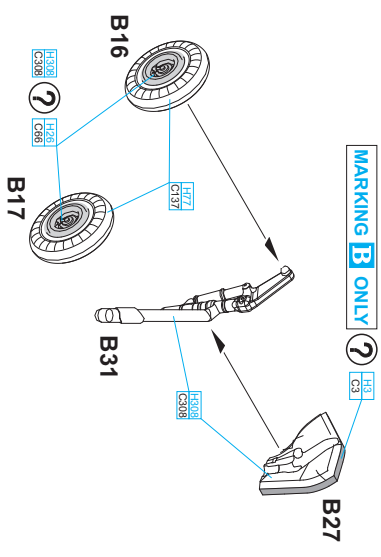
L**R**

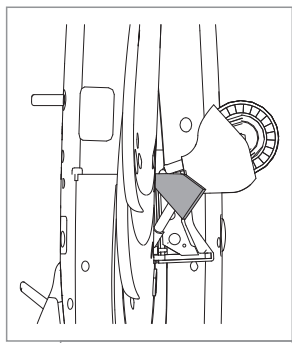
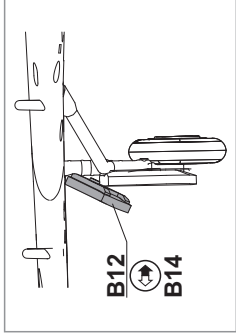
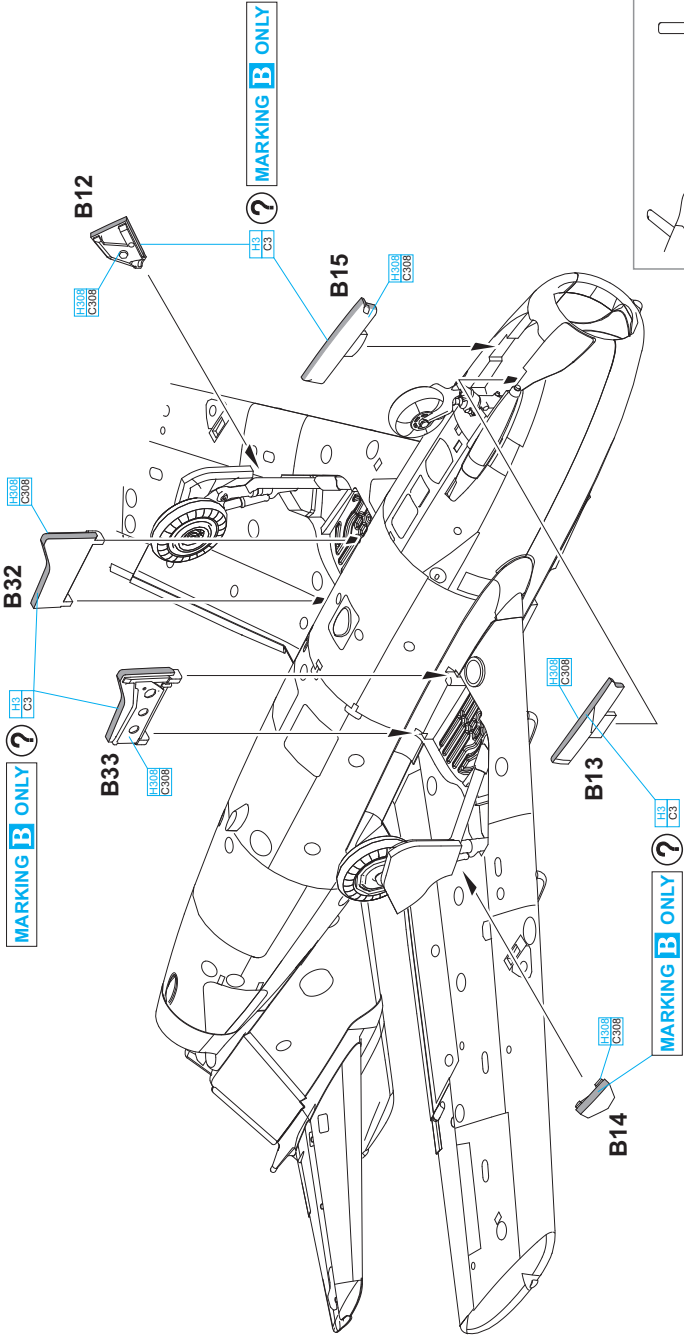

MARKINGS **A**, **B**, **F**, **G**, **H** ONLY

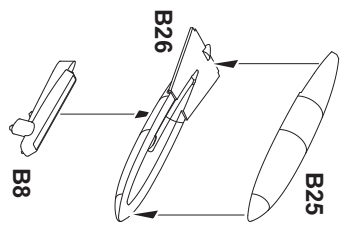
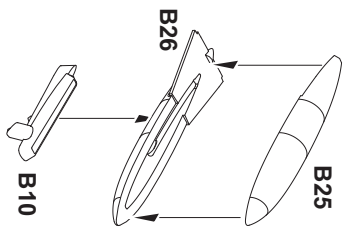
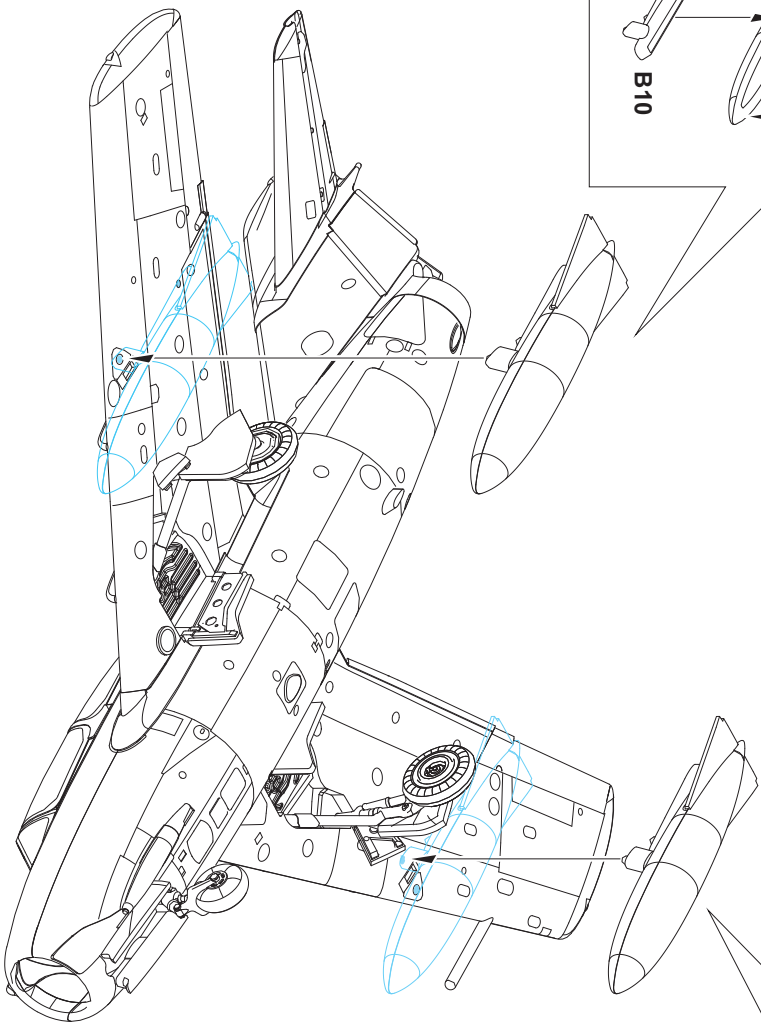

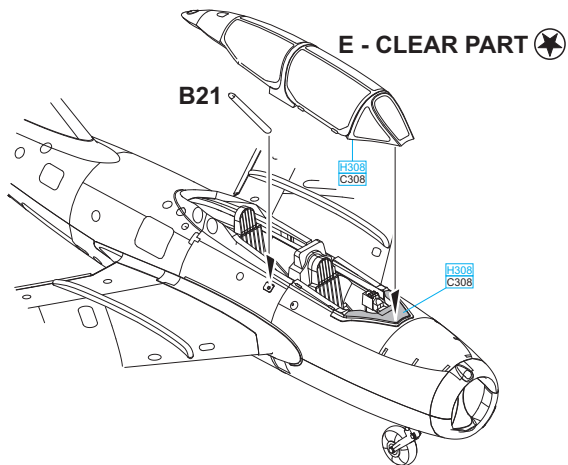

eduard
MASK

4444

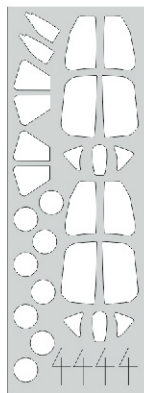

2 pcs.
B16 (?) B17



B16 (?) B17
2 pcs.

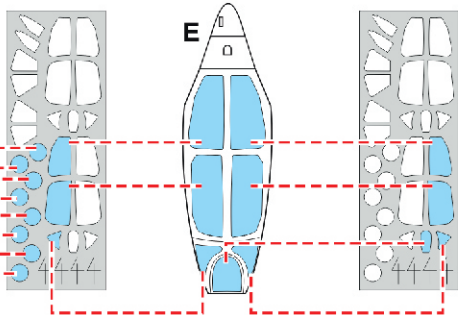
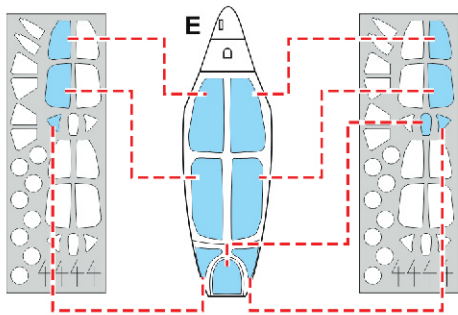

MARKINGS A, B, C, D, E ONLY (?)

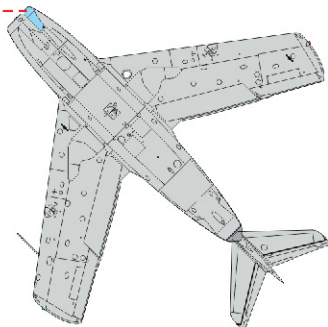
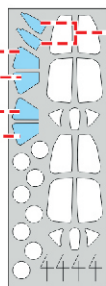
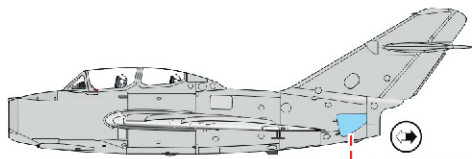

A UTI MiG-15, 18. sbolp, Pardubice, Czechoslovakia, September 1962

Spurred on by the Cuban Missile Crisis, the first international exercises for the members of the Warsaw Pact organised on Czechoslovak territory were named Vitr (Wind) 1962. MiG-15s of the 18th sbolp participated, flying out of Pardubice. Military equipment for the event was often camouflaged using water soluble paints, and the MiG-15s of the 18th sbolp were no exception.

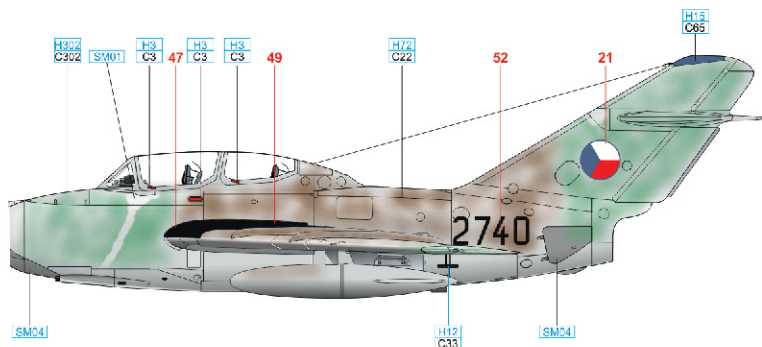

ČESKOU VERZI TEXTU NALEZNETE NA www.eduard.cz POD KATALOGOVÝM ČÍSLEM 4444

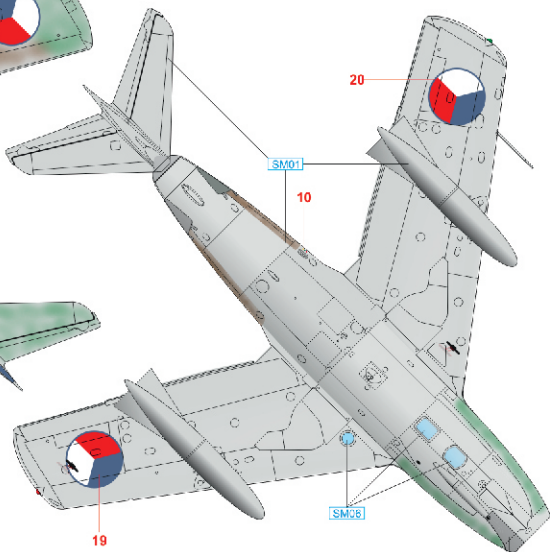
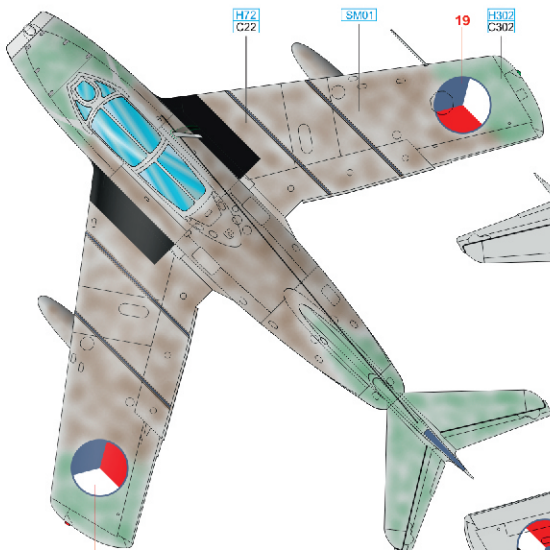

20

19

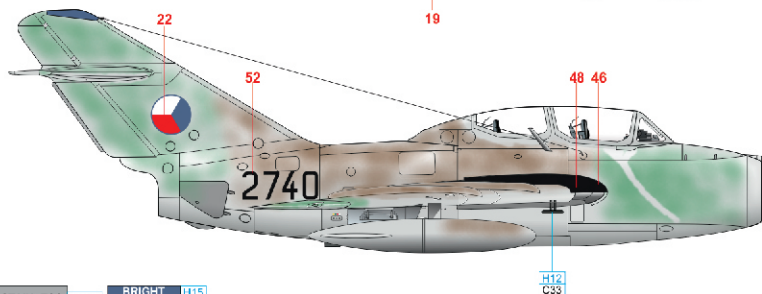

2740

BROWN	H72 C22	STAINLESS	SM04	BRIGHT BLUE	H15 C85
GREEN	H302 C302	SILVER	SM01	CHROME SILVER	SM02
		BLACK	H12 C33	RED	H3 C3

B UTI MiG-15, Air Museum Prague – Kbely, Czechoslovakia, end of 1960s

This aircraft, currently on display at the Air Museum in Prague-Kbely, was built on November 12th, 1955 and was retired on June 25th, 1966. It was reportedly moved to the base at Kbely during the years that the museum was established in 1967-68.

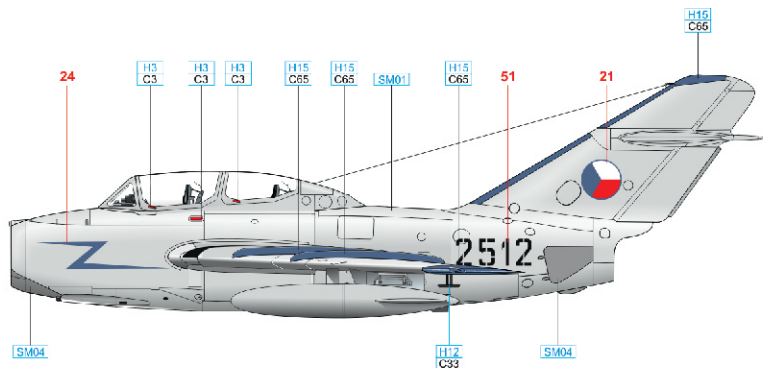

ČESKOU VERZI TEXTU NALEZNETE NA
www.eduard.cz
 POD KATALOGOVÝM ČÍSLEM 4444

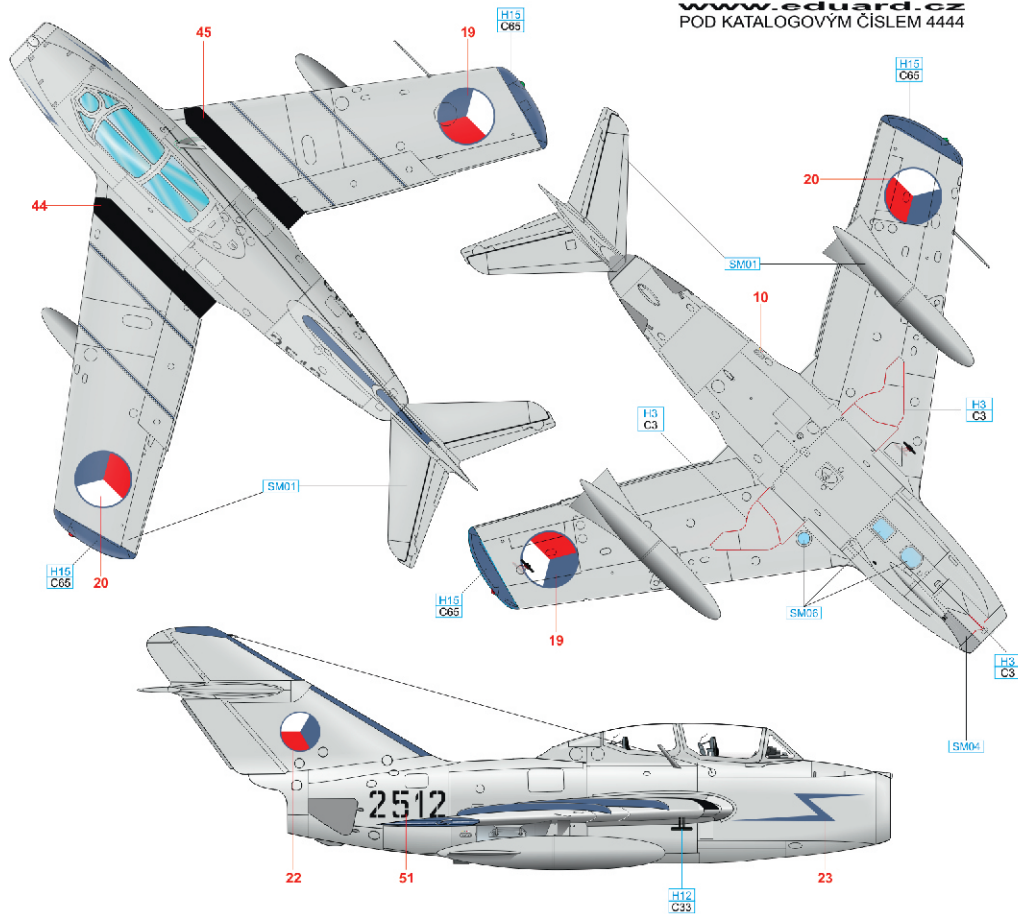

SILVER SM01 BRIGHT BLUE H15 C66 RED H3 C3 STAINLESS SM04 CHROME SILVER SM06 BLACK H12 C33

eduard

C UTI MiG-15, Soviet Union, 1960s through the 1970s

Many Soviet two-seater UTI MiG-15s wore the underlined letter 'U' in Cyrillic along with the fuselage number. It was the abbreviation of the term 'uchobny', meaning 'training'. Black walkways are not visible in the photo of this aircraft.

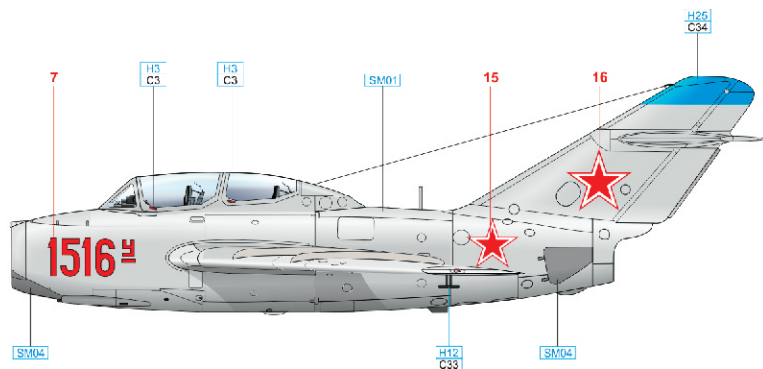

ČESKOU VERZI TEXTU NALEZNETE NA
www.eduard.cz
 POD KATALOGOVÝM ČÍSLEM 4444

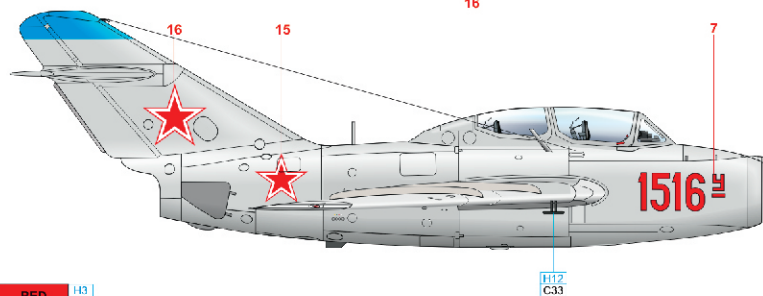
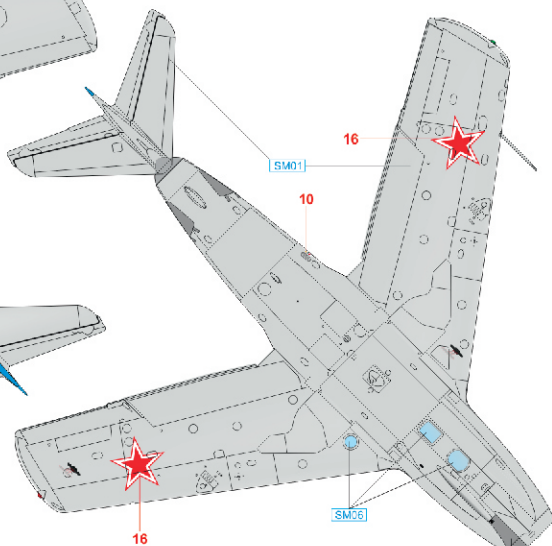
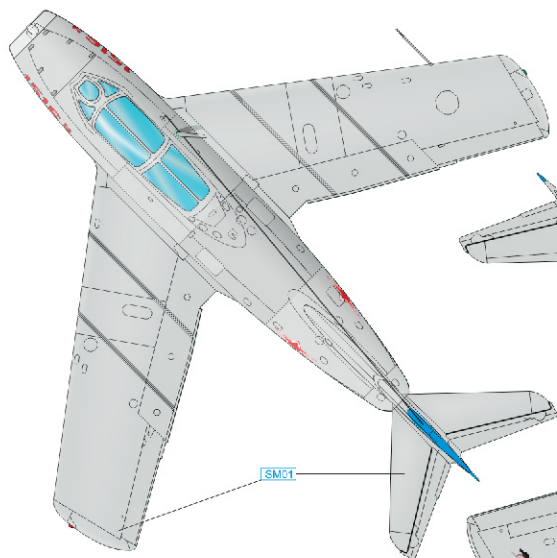

CHROME SILVER	SM06	RED	H13 C3
SILVER	SM01	STAINLESS	SM04
		BLUE	H25 C34
		BLACK	H12 C33

eduard

D UTI MiG-15, c/n 922226, Hävittäjälentolaivue 31, Rissala Air Base, Finland, Late 1960s

This aircraft was sold to Finland on November 10th, 1962. It crashed on November 27th, 1970 and was written off. During the fall of 1969, it escorted Czechoslovak president Ludvík Svoboda's Il-18 during his visit to Finland. The lynx silhouette places this aircraft with Hävittäjälentolaivue 31 (Fighter Squadron 31).

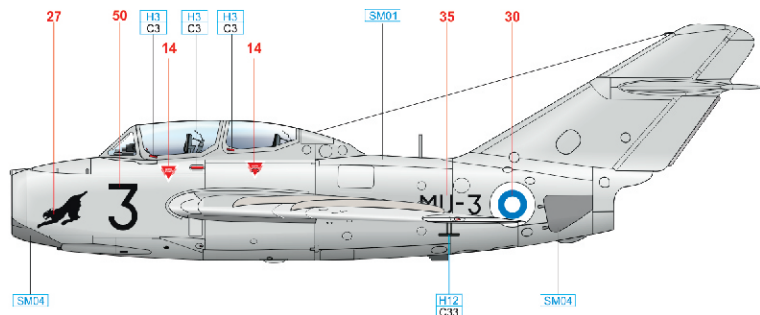

ČESKOU VERZI TEXTU NALEZNETE NA www.eduard.cz POD KATALOGOVÝM ČÍSLEM 4444

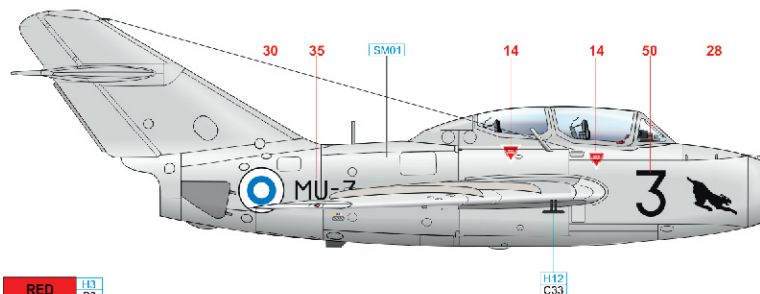
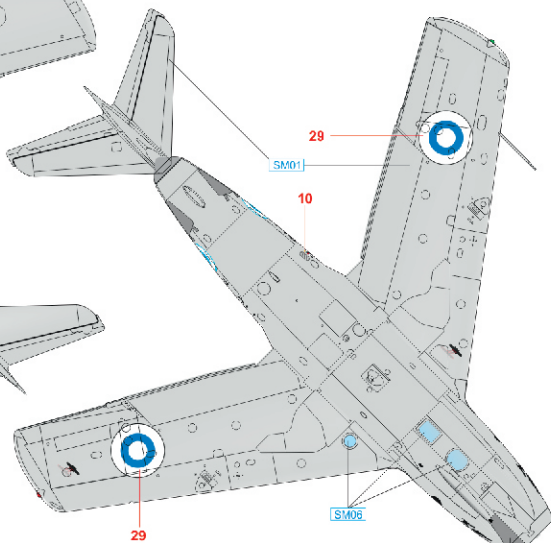
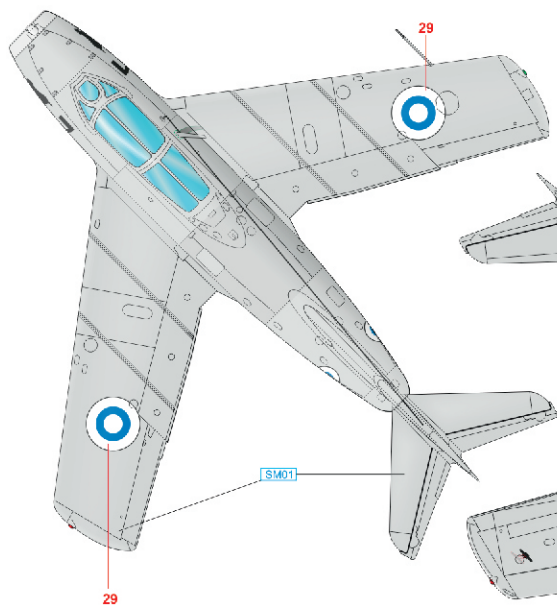

BLACK	H12 C33	RED	H13 C3
SILVER	SM01	STAINLESS	SM04
		CHROME SILVER	SM06

E UTI MiG-15, Indonesian Air Force, Jakarta-Kemajoran Air Base, Indonesia, 1960s

A total of fifteen Czechoslovak built UTI MiG-15s was delivered to Indonesia during the late fifties. All were taken out of inventory in 1973 when the T-33A Shooting Star replaced them. The colorful tail appeared on Indonesian MiG-17s and MiG-21s as well.

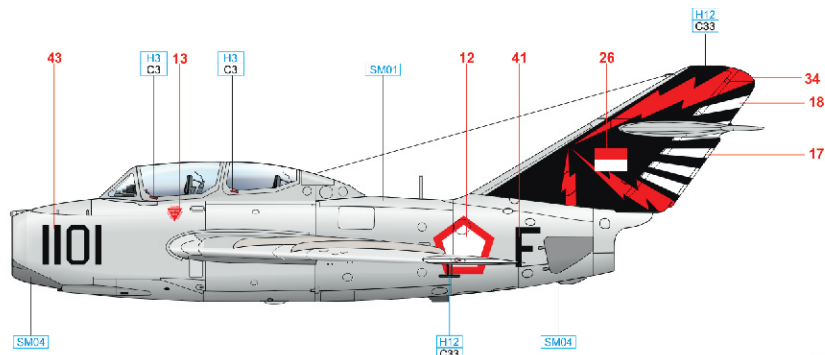

ČESKOU VERZI TEXTU NALEZNETE NA
www.eduard.cz
POD KATALOGOVÝM ČÍSLEM 4444

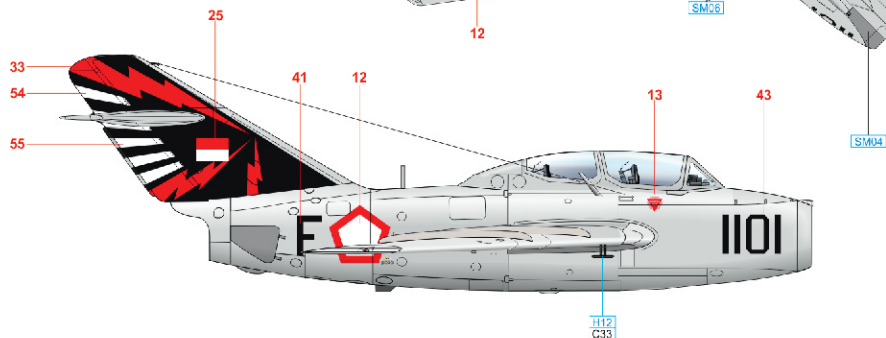
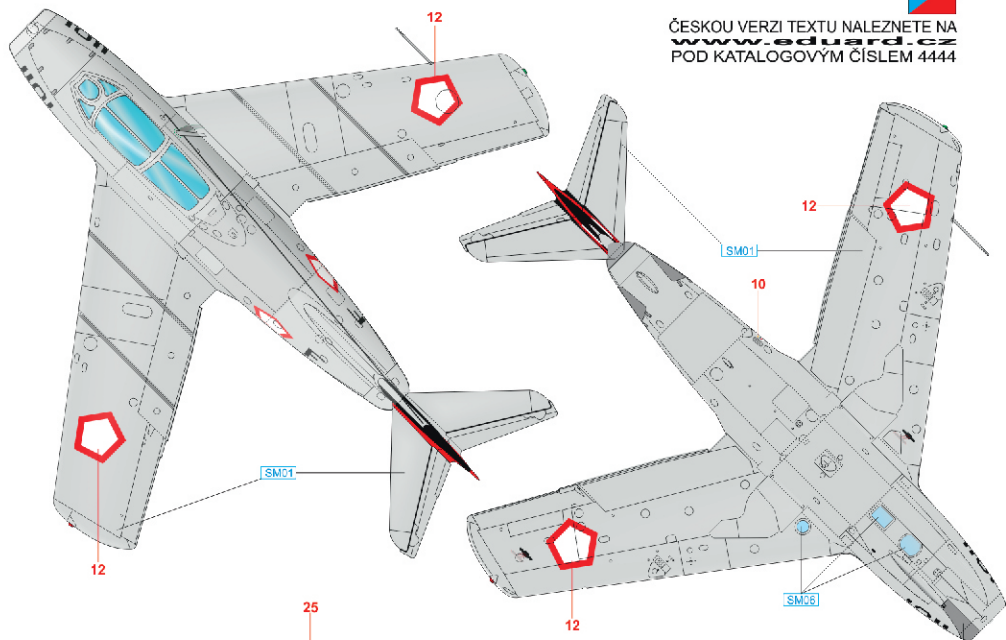

SILVER SM01 STAINLESS SM04 CHROME SILVER SM06 RED H3 C3 BLACK H12 C33

eduard

F UTI MiG-15, Syrian Air Force

This aircraft was a part of the Damascus Military Museum exhibition. It was manufactured in Czechoslovakia. Four two-seaters were delivered to Syria directly from Czechoslovakia, more were purchased from Poland. They were still in service during the 90s.

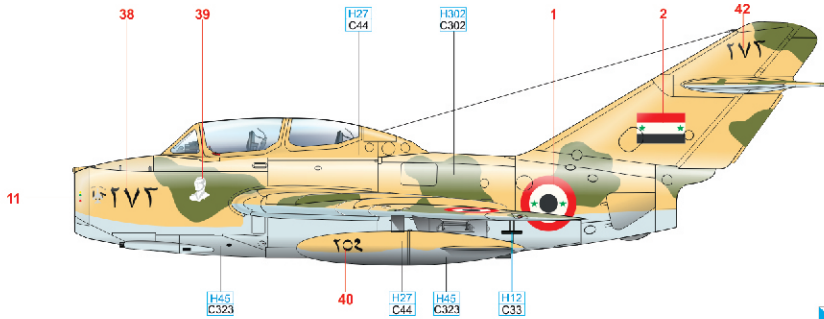

ČESKOU VERZI TEXTU NALEZNETE NA
www.eduard.cz
 POD KATALOGOVÝM ČÍSLEM 4444

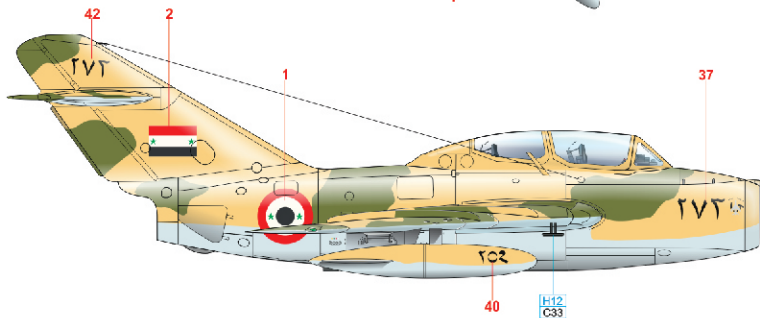
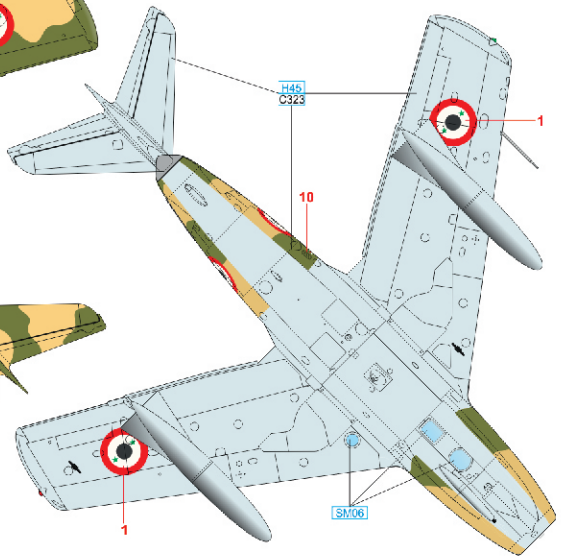
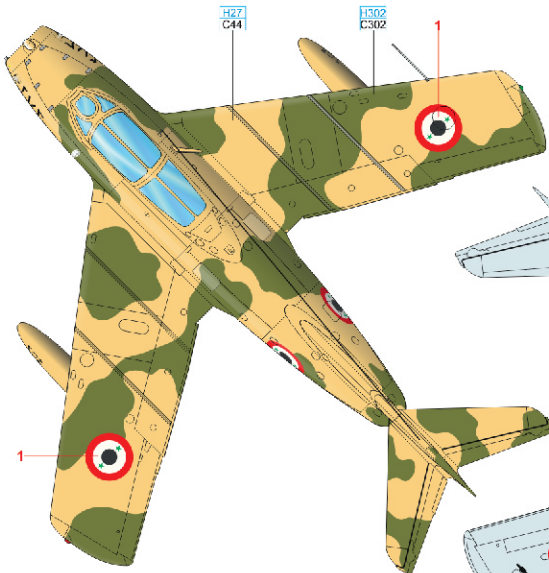

LIGHT BLUE	H45 C323	TAN	H27 C44	GREEN	H302 C302	BLACK	H112 C33	CHROME SILVER	SM06
------------	-------------	-----	------------	-------	--------------	-------	-------------	---------------	------

G UTI MiG-15, Iraqi Air Force, 1980s

This aircraft was manufactured in Czechoslovakia and was probably one of the surplus aircraft sold by Czechoslovakia to Iraq in the early seventies. No. 874 remained in service until the late 1980s. Aircraft No. 874 was overhauled in Czechoslovakia in 1987.

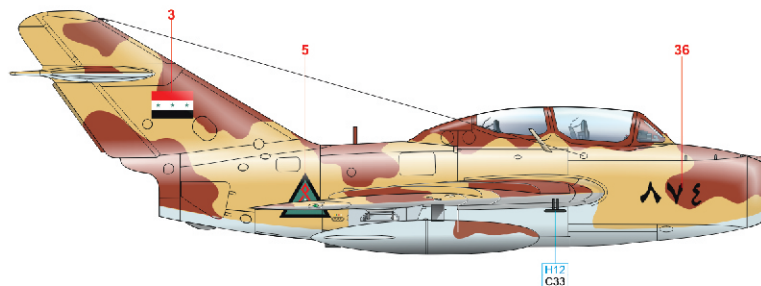
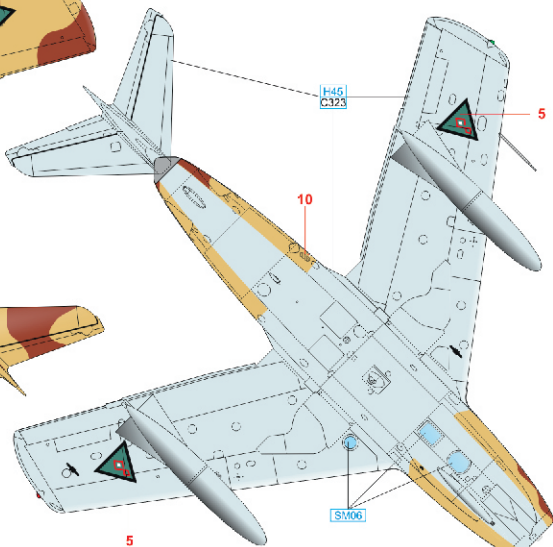
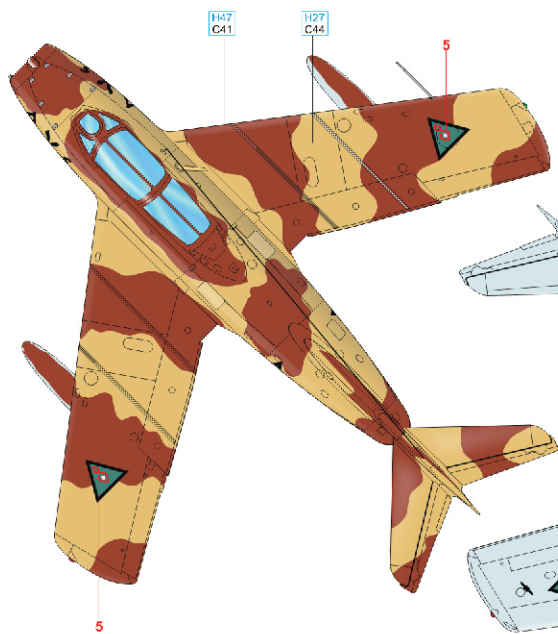
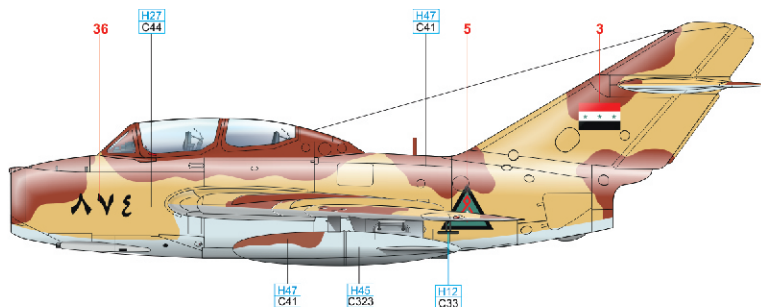

ČESKOU VERZI TEXTU NALEZNETE NA
www.eduard.cz
 POD KATALOGOVÝM ČÍSLEM 4444

LIGHT BLUE H45 C323 TAN H27 C44 RED BROWN H47 C41 BLACK H12 C33 CHROME SILVER S106

H UTI MiG-15, Algerian Air Force, 1960s through the 1980s

The Algerian Air Force obtained its first examples of the MiG-15 in the mid sixties. Twenty of them were still in service in 1984. The presence of the national insignia on the upper starboard and lower port wings is unclear. Current Algerian aircraft repeat the fuselage codes in these locations.

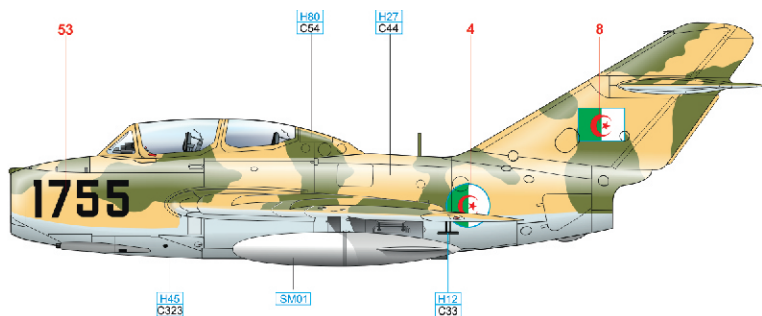

ČESKOU VERZI TEXTU NALEZNETE NA
www.eduard.cz
 POD KATALOGOVÝM ČÍSLEM 4444

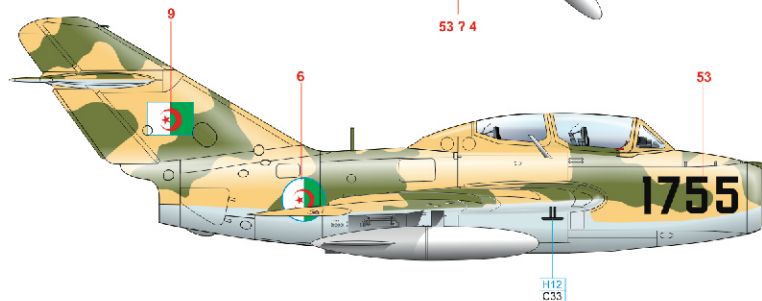
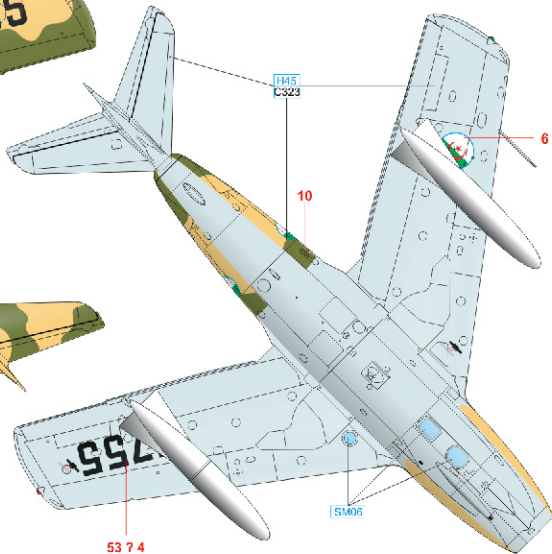
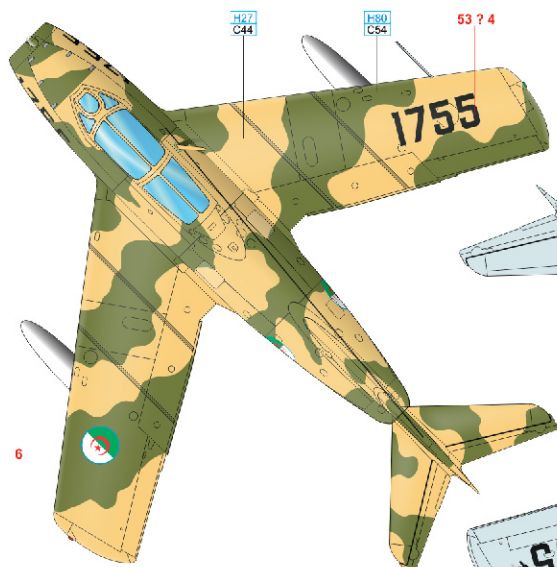

SILVER	SM01	KHAKI GREEN	H80 C64	LIGHT BLUE	H45 C323	CHROME SILVER	SM06	TAN	H27 C44	BLACK	H12 C33
--------	------	-------------	---------	------------	----------	---------------	------	-----	---------	-------	---------

eduard

MiG-15bis Dual Combo

Cat. No. 4442



MiG-21BIS Dual Combo

Cat. No. 4427

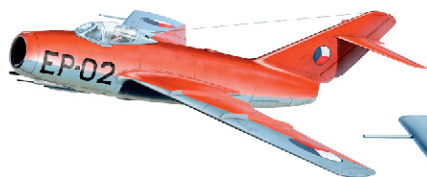

MiG-15 Dual Combo

Cat. No. 4443

