

1:35 Scale

ITEM No.:82495



**Soviet T-26 Light Infantry Tank Mod. 1933**  
**ソビエト T-26 軽戦車 1933 年型**  
**苏联 T-26 轻型坦克 1933 年型**

**PLEASE READ BEFORE OPERATION!**

- \* Tools recommended as below: (Not included)  
Adhesives; Paints; Side Cutters, Sharp Edged Pliers, Modeling Knife; Modeling File; Nippers, Drill; Scissors; Sand Paper; Soft Cloth; Cyanoacrylate Glue.
- \* Make sure to read this instruction listed below before assembling.
- \* The kit contains the small parts, they can be dangerous if swallowed by mistake, so keep them away from reach of children.
- \* Cut the all parts off carefully and remove the waste parts into the garbage can.
- \* More caution and care should be needed for cutting and handling the photo etched parts.
- \* Make attention that some parts should be attached the decal when assembled.
- \* During assembling, please tear up and throw away the plastic bags, or may cause the dangerous if wearing over head by children's mistake.
- \* When using the adhesives and paints, please do not use them in the closed room or near the fire, also must be very careful to protect your eyes, face and clothes.
- \* Adult supervised when assembled by children under 14 years old.

**装配前请仔细阅读:**

- \* 推荐使用的模型工具(请自备):  
专用模型胶水, 专用模型油漆, 水口剪刀, 长咀钳, 刀片, 锉刀, 镊子钳, 钻, 剪刀, 软布, 砂纸, 瞬间快干胶等。
- \* 用水口剪刀或刀片小心切下所有塑胶零件和蚀刻片零件, 不要遗失小零件。
- \* 切取蚀刻片时应特别注意防止利边划伤手指。
- \* 用模型锉刀小心锉平所有零件表面的注射浇口。
- \* 用适量的强力快干胶水粘合蚀刻片零件和金属轴, 切忌过量, 否则可能导致可动零件被粘住。
- \* 注意某些零件表面需在装配时同步贴水上贴纸。
- \* 制作时应远离幼儿并将包装袋及时收妥, 谨防小孩玩耍而引起意外。



using ca super glue  
使用强力胶



weight  
配重



make hole  
钻孔



cut / remove  
切除



option  
选择



no cement  
不涂胶水



decal  
贴纸



bend  
弯曲



repair  
填补

**The method to apply the decals**

1. Cut off the decal from the decal paper and put it into the warm water 40°C for 10 seconds.
2. Take the decal from the water and put it on a piece of clean cloth.
3. Remove the decal slowly from the paper to the targeted location by a wet finger.
4. Use a piece of dry and soft cloth to press it gently on the decal until it getting dry and no bubble existing.

**水贴纸的使用方法:**

- 一. 把相关的印花从水贴上剪下, 放入40°C左右的温水中浸10秒。
- 二. 然后将印花放在干净的布上。
- 三. 拿上印花纸板, 手指蘸水将印花移到适当的位置。
- 四. 用软干布轻压印花直至水干, 气泡消失。

部品图  
Parts

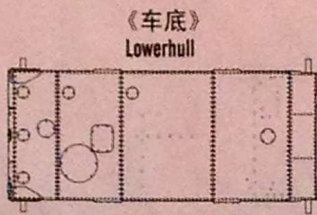

Ax4

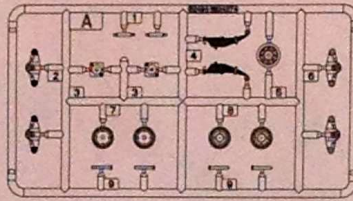

Cx4

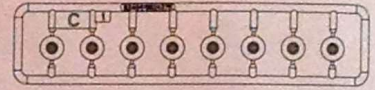

E

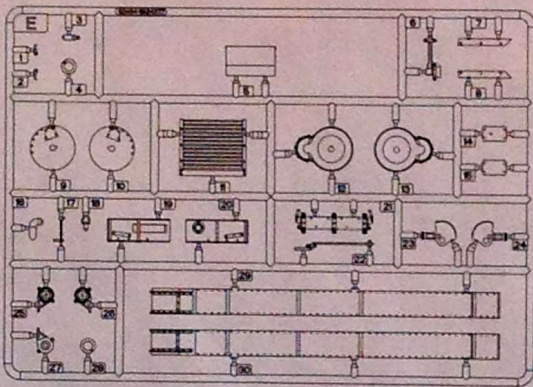

Dx2

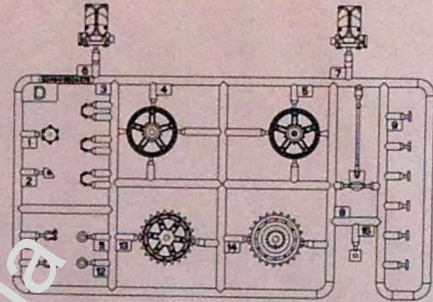

J

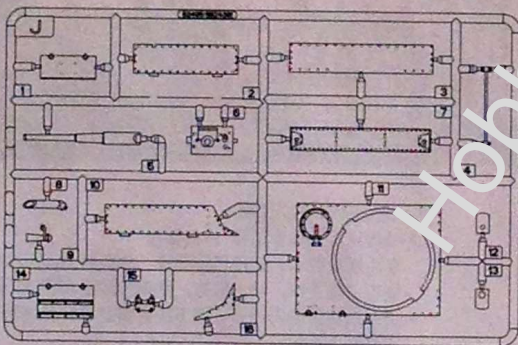

H

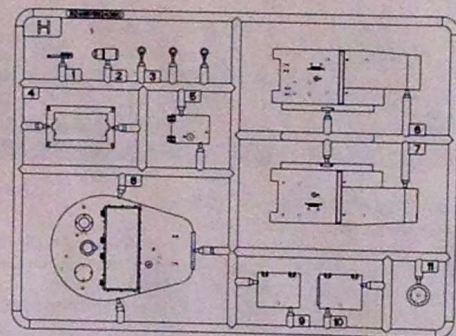

K

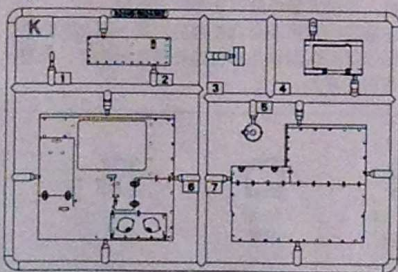

Q

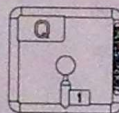

固定板  
Board

1/35 T26

82494-09020029

Tx120

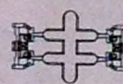

T8x24

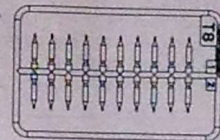

《蚀刻片》-A  
Photo etched



水贴  
Decal



不用部件: PE-1, PE-A3, PE-A5, PE-A6, H2  
Unused parts

**1**  
STEP

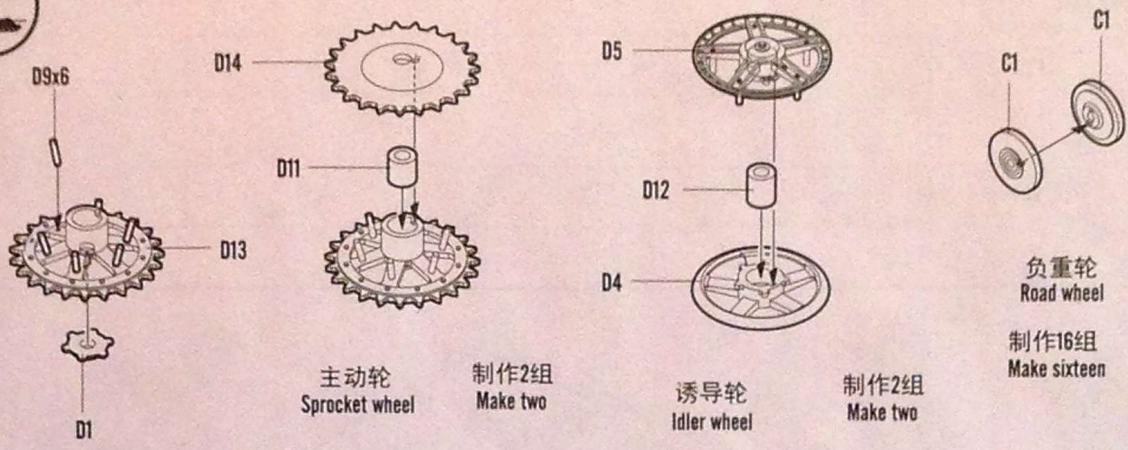

**2**  
STEP

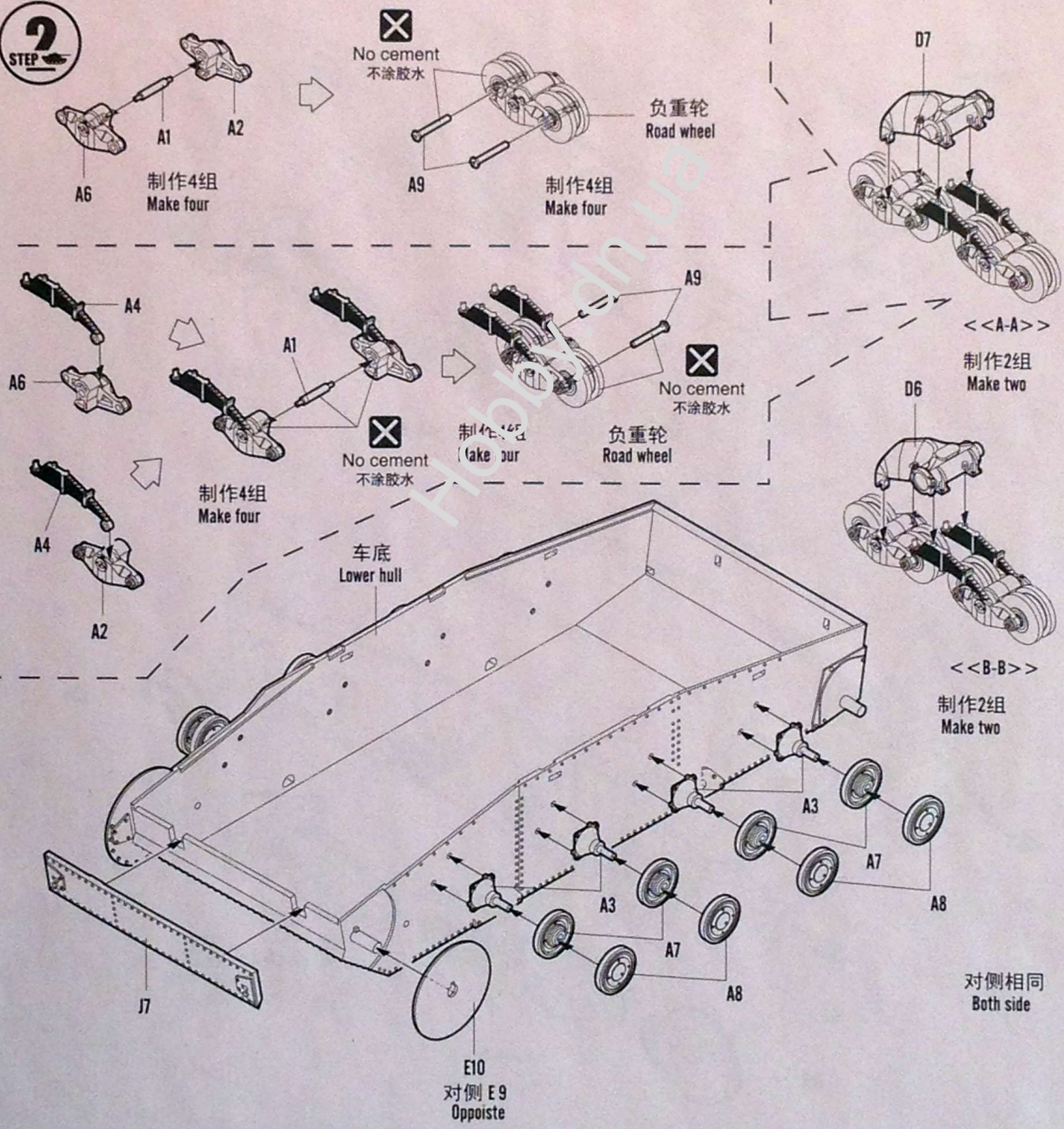

**3**  
STEP

钻穿图中指示的孔位  
Make holes

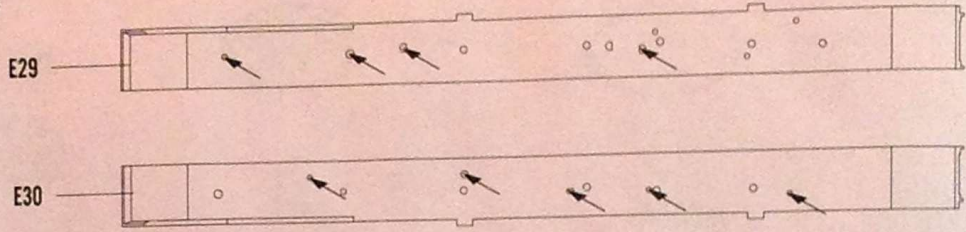

**4**  
STEP

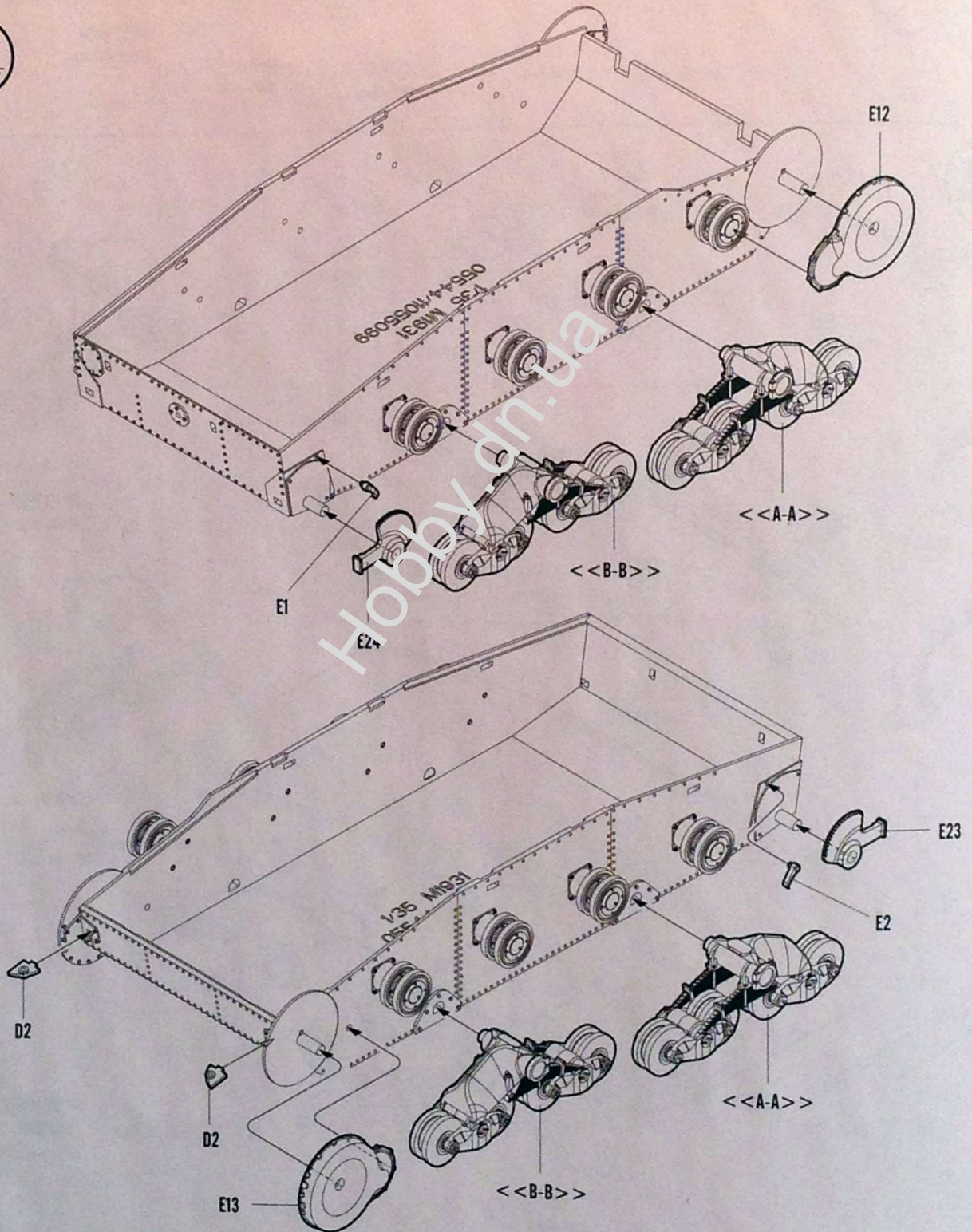

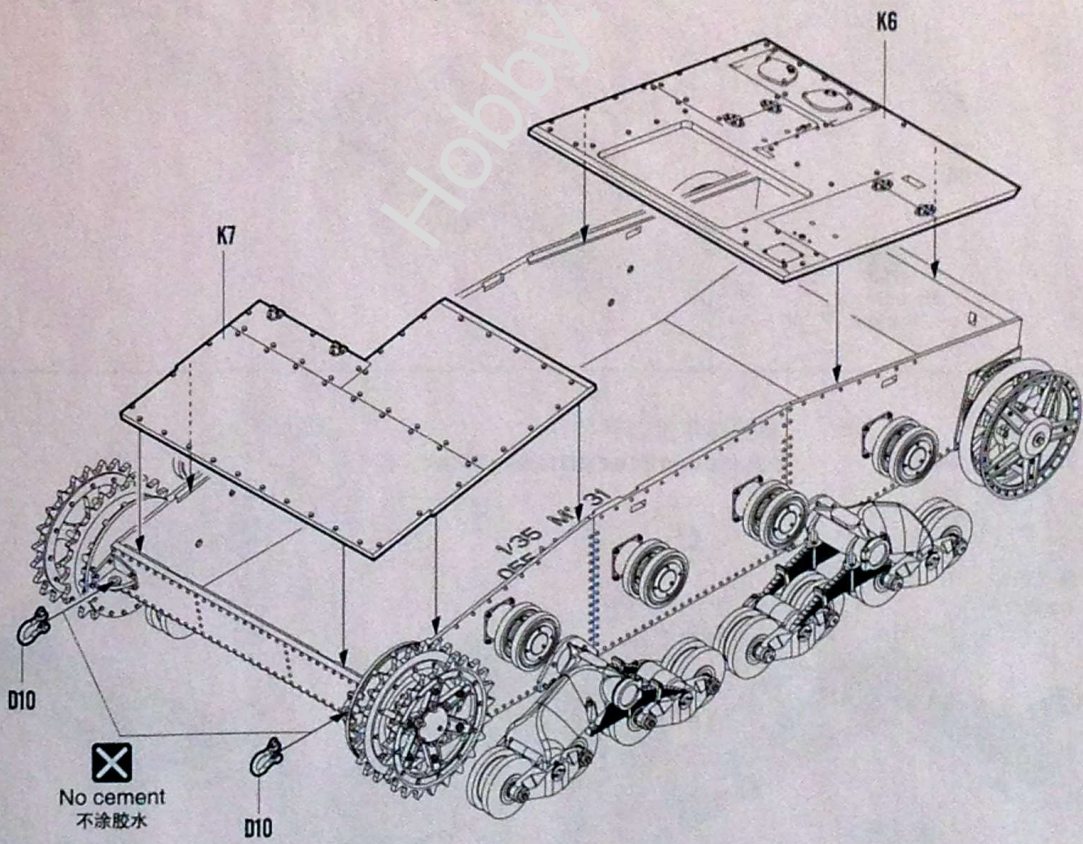
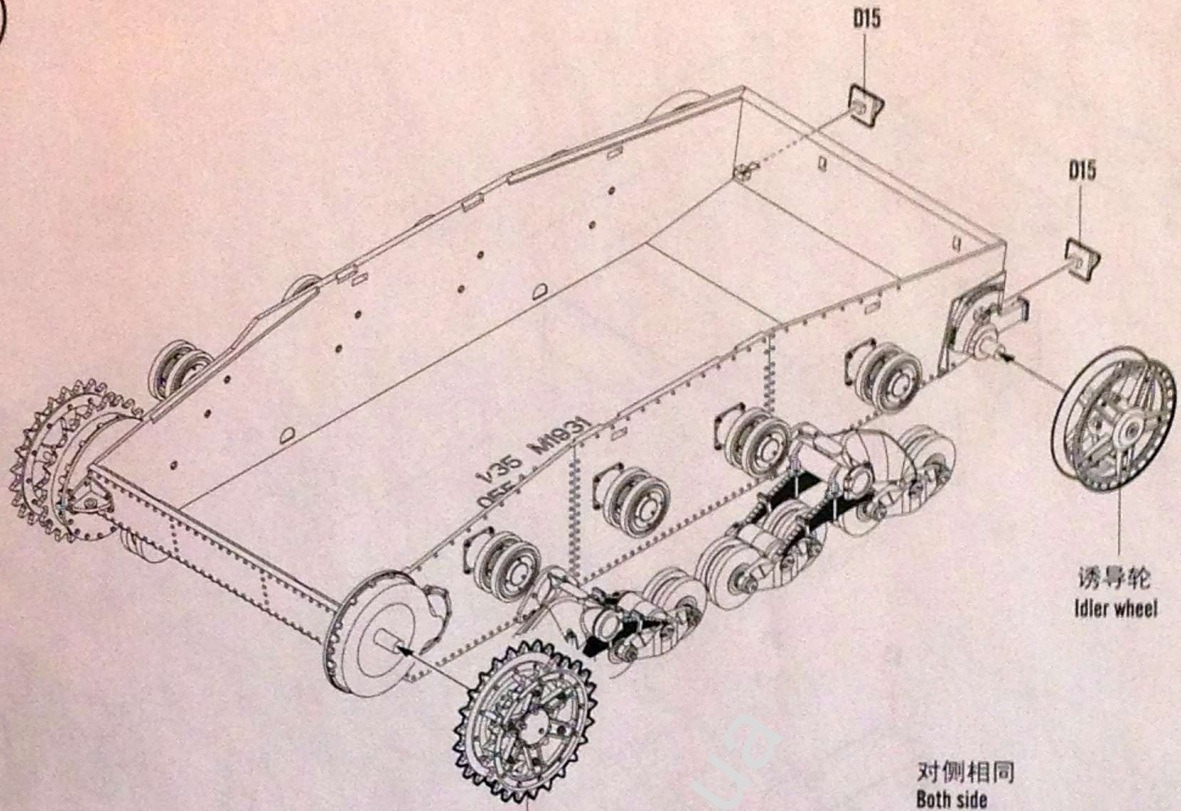

**6**  
STEP

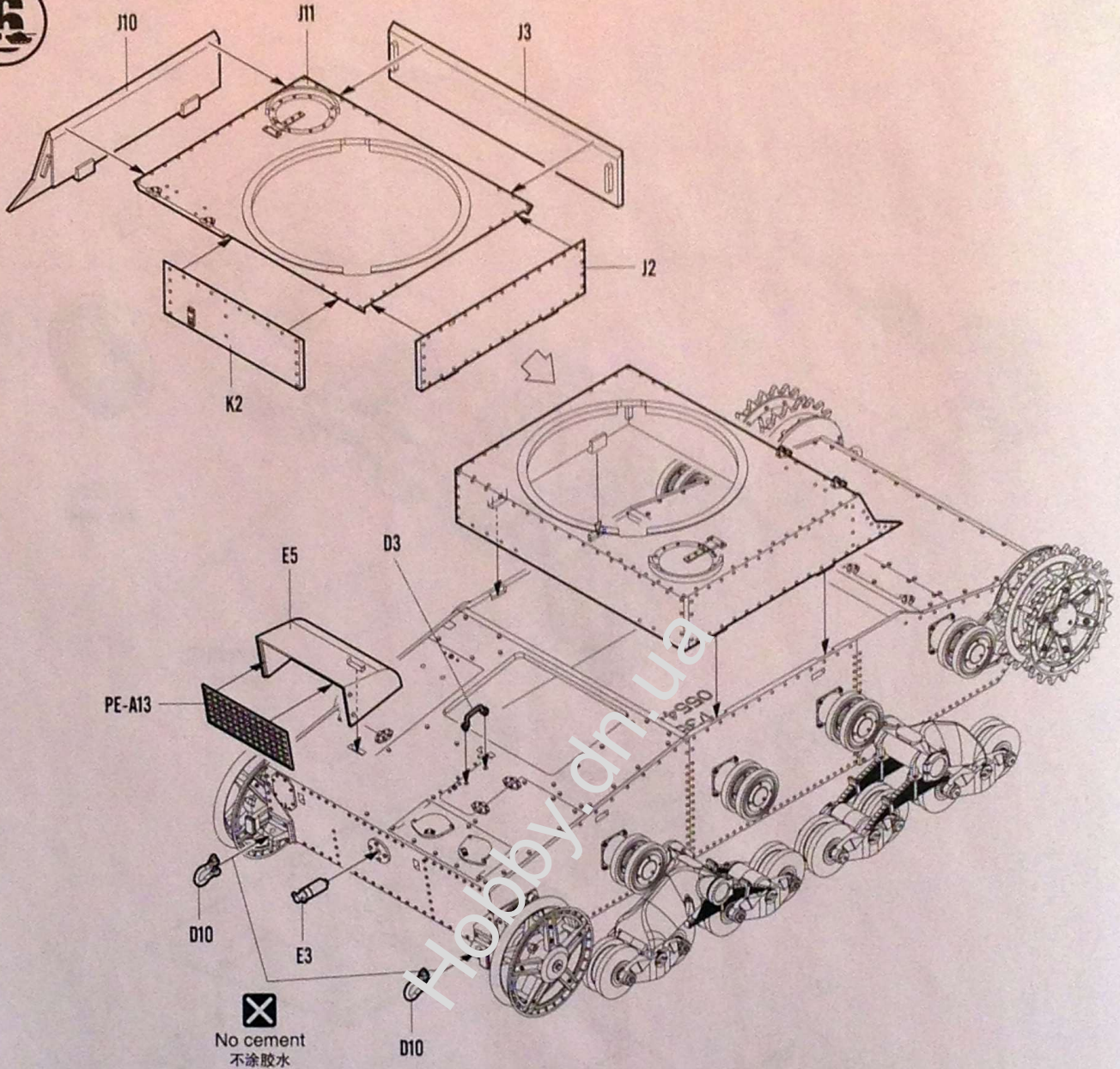

**7**  
STEP

履带联接  
Track construction

单侧履带需113节  
Complete track for one side requires 113 links

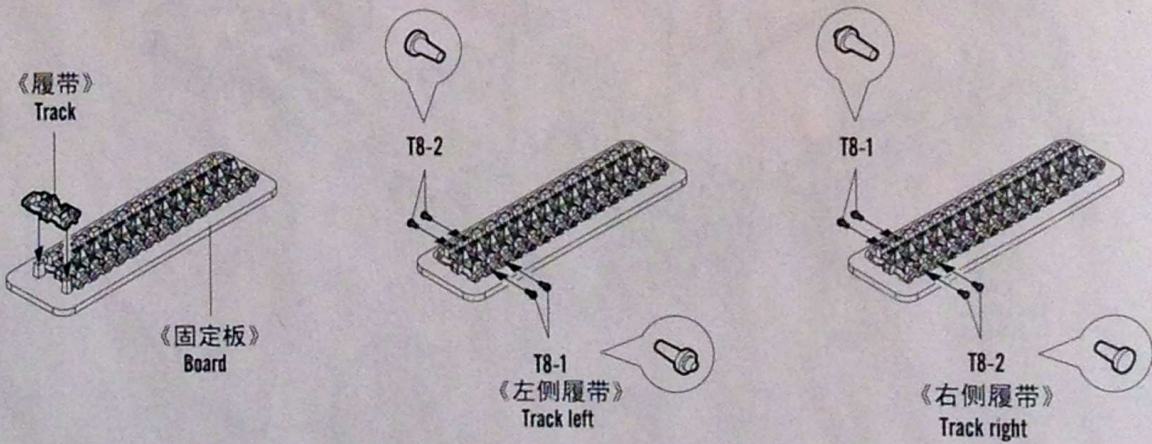

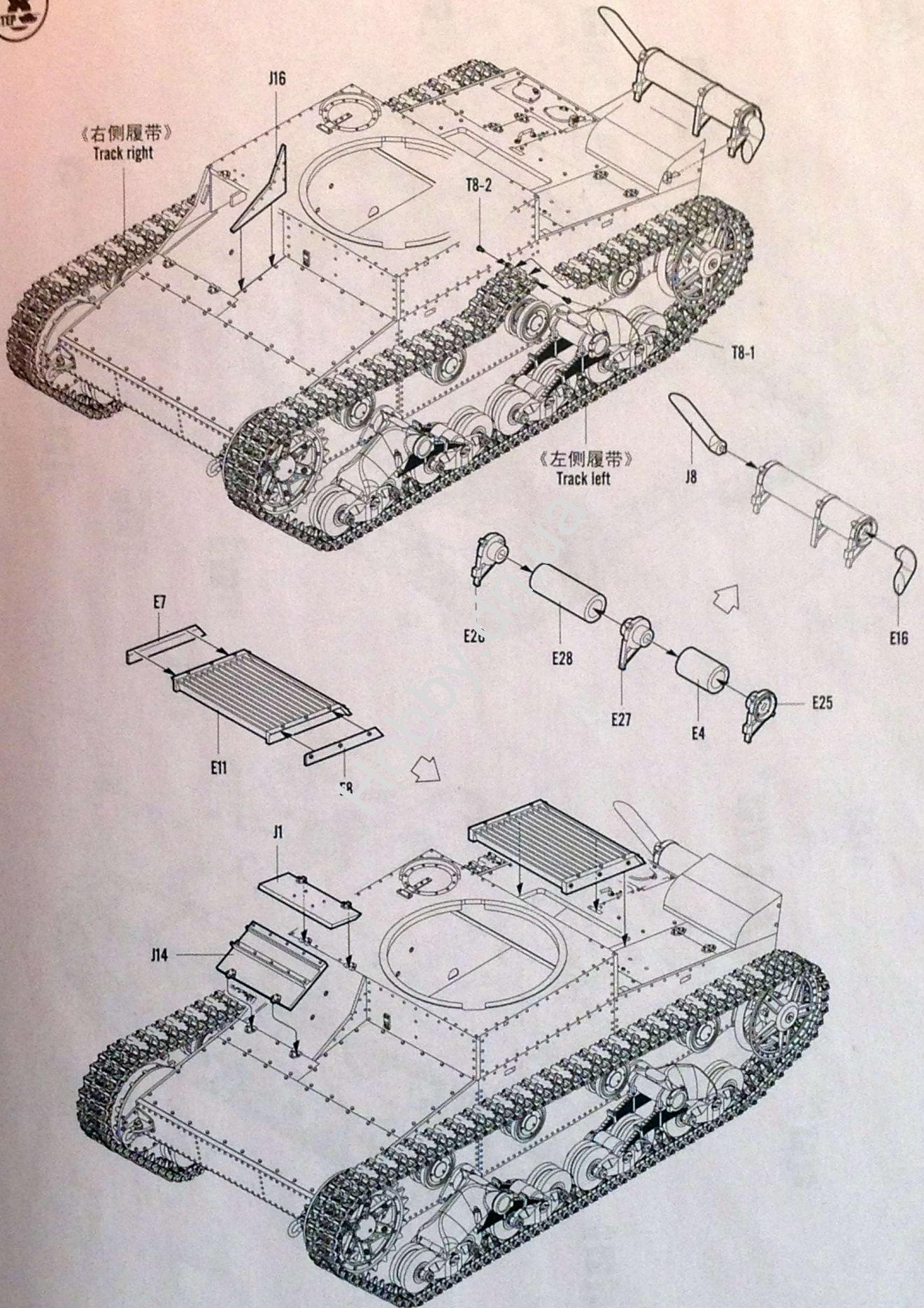

**Q**  
STEP

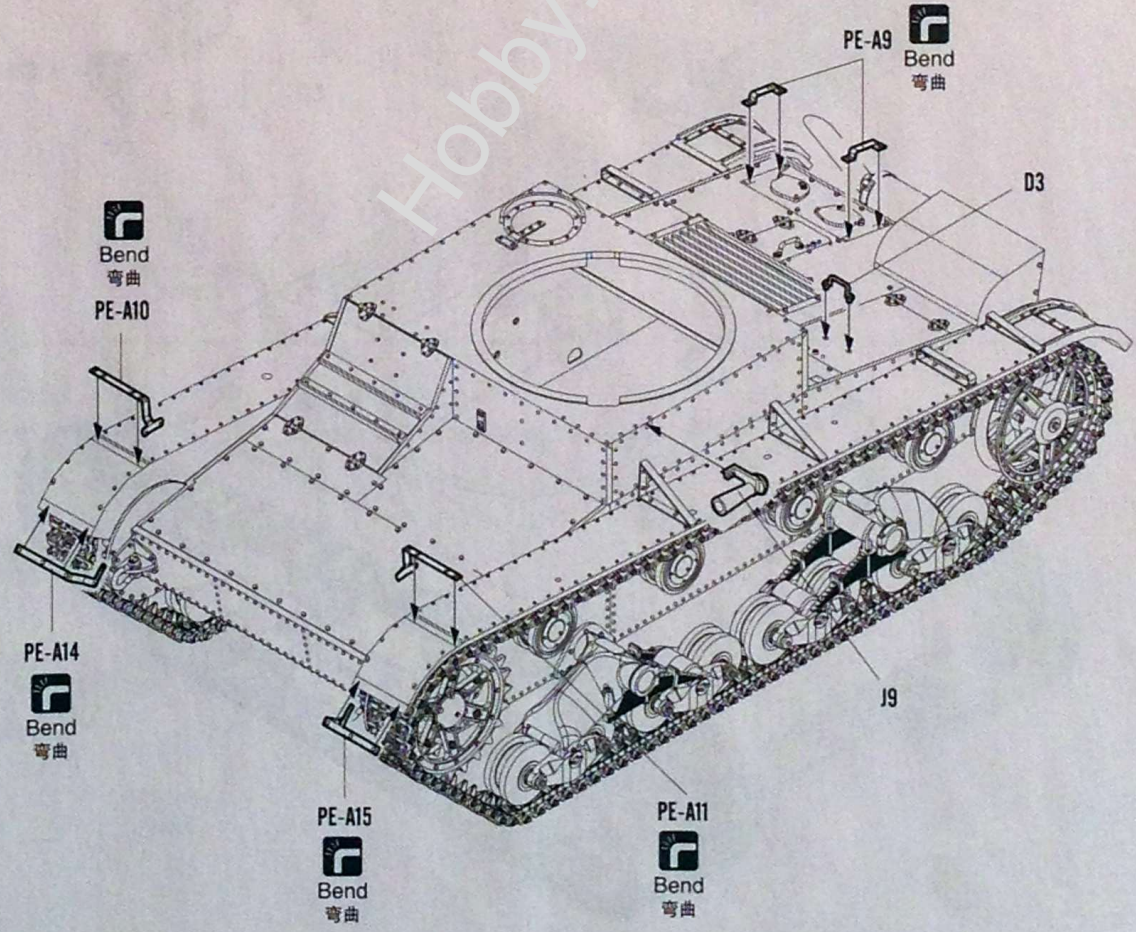
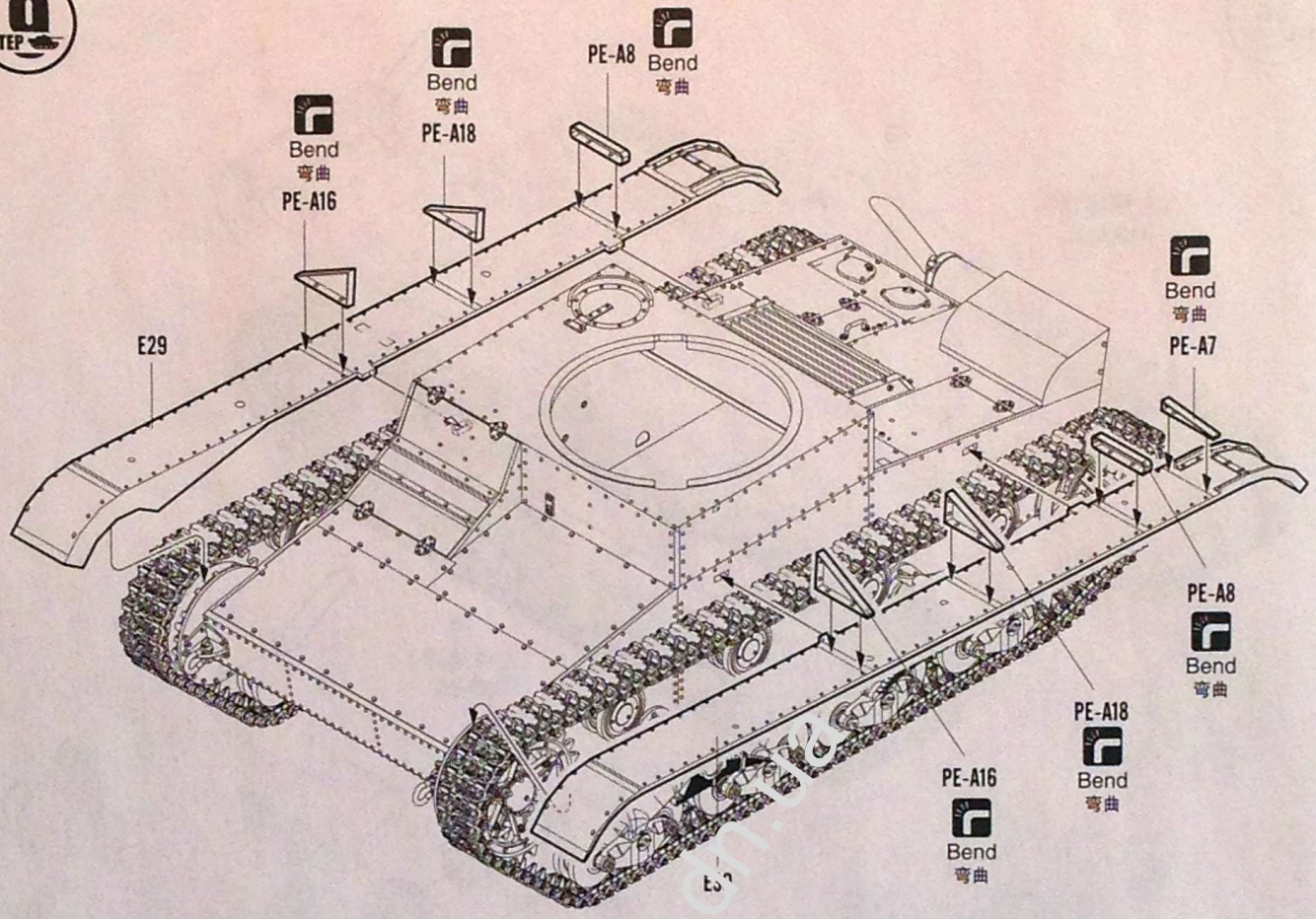



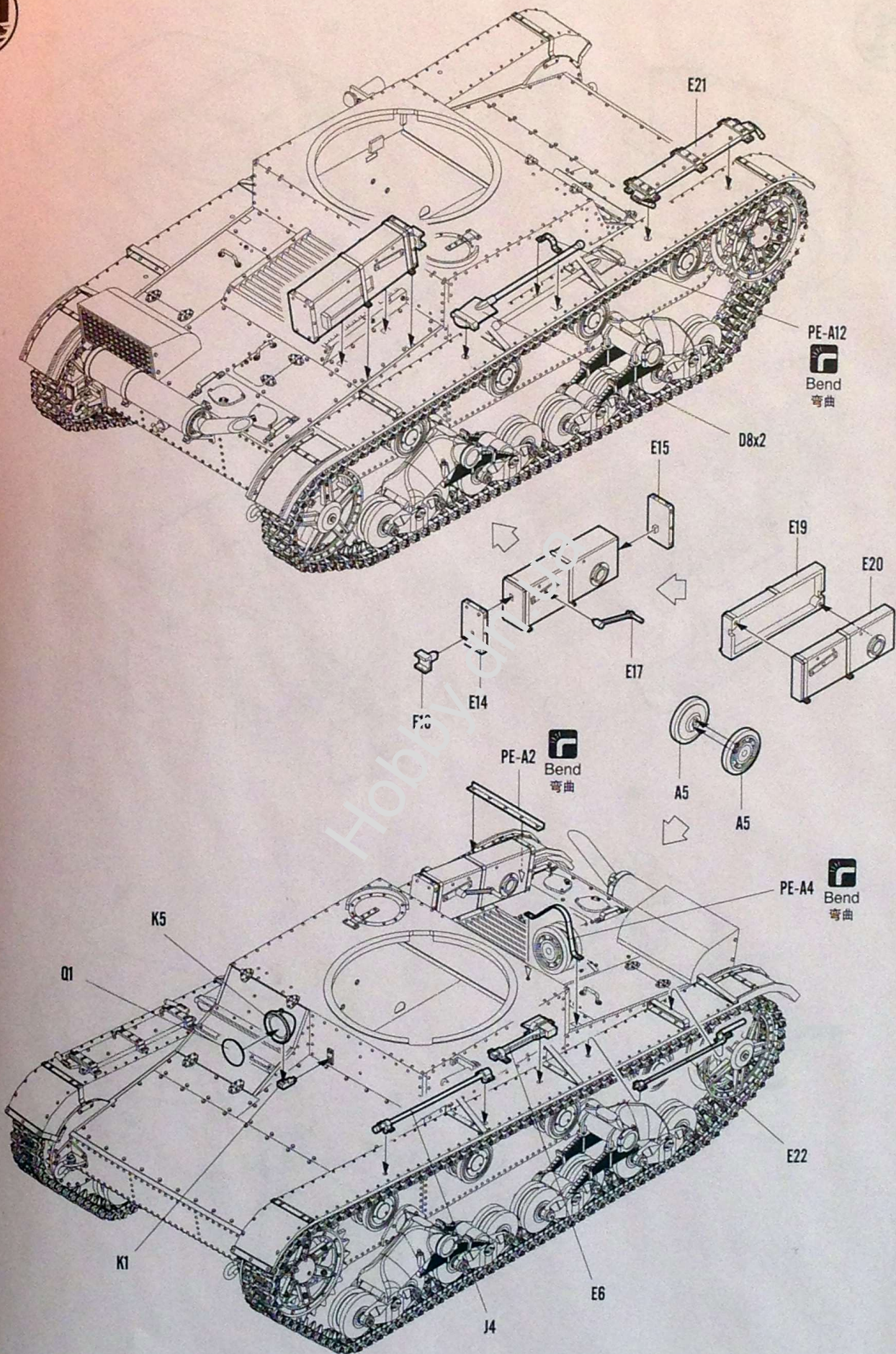

**11**  
STEP

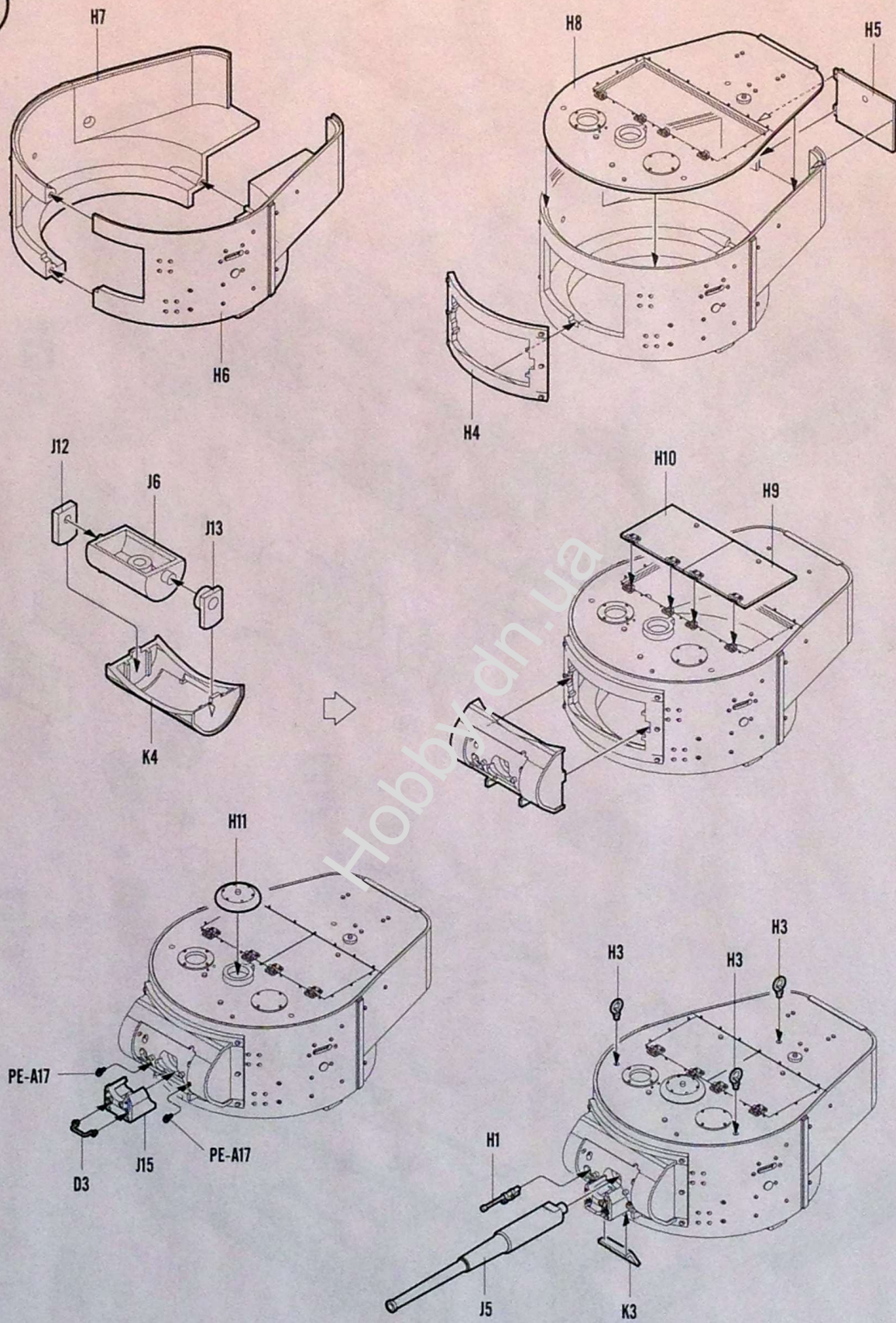

12  
STEP

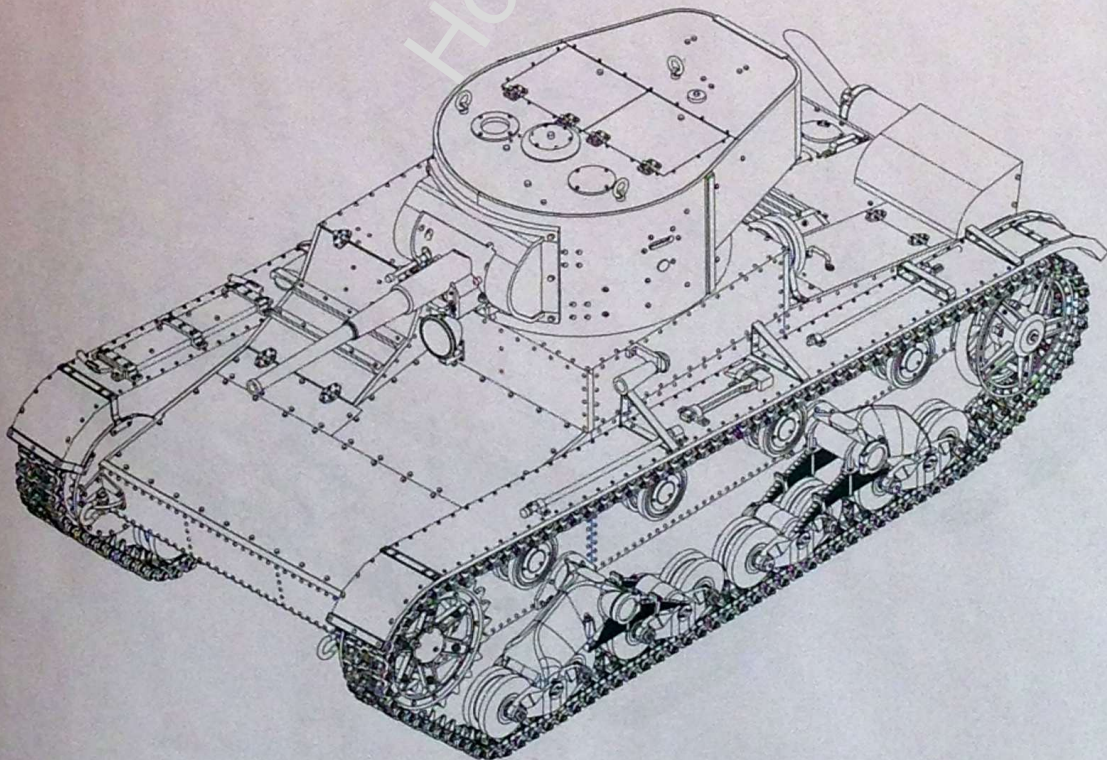
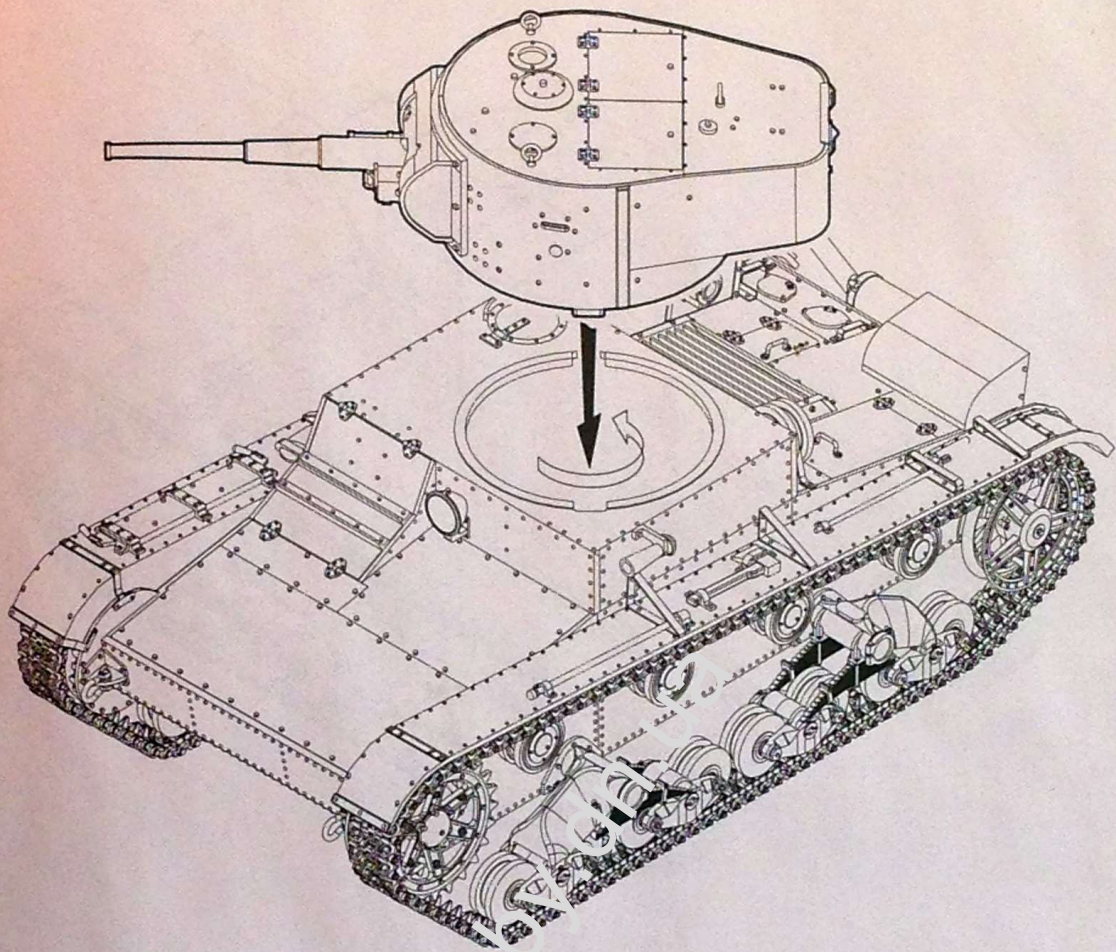

13  
STEP

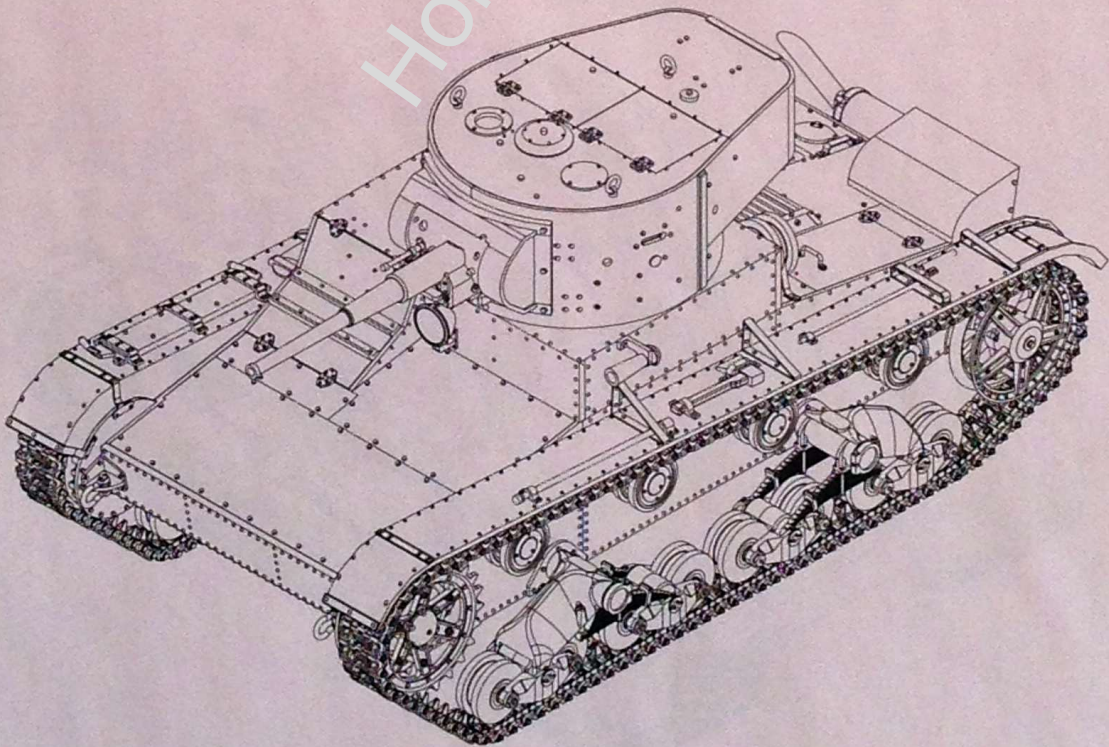
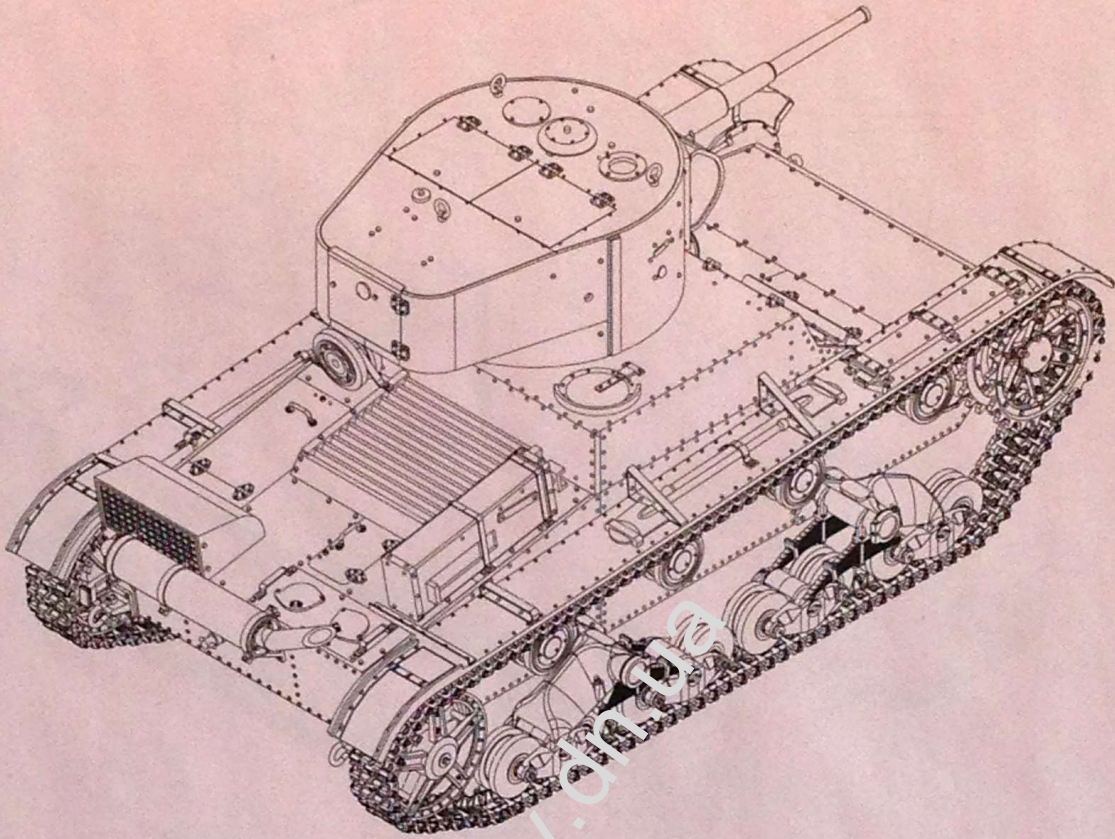

I

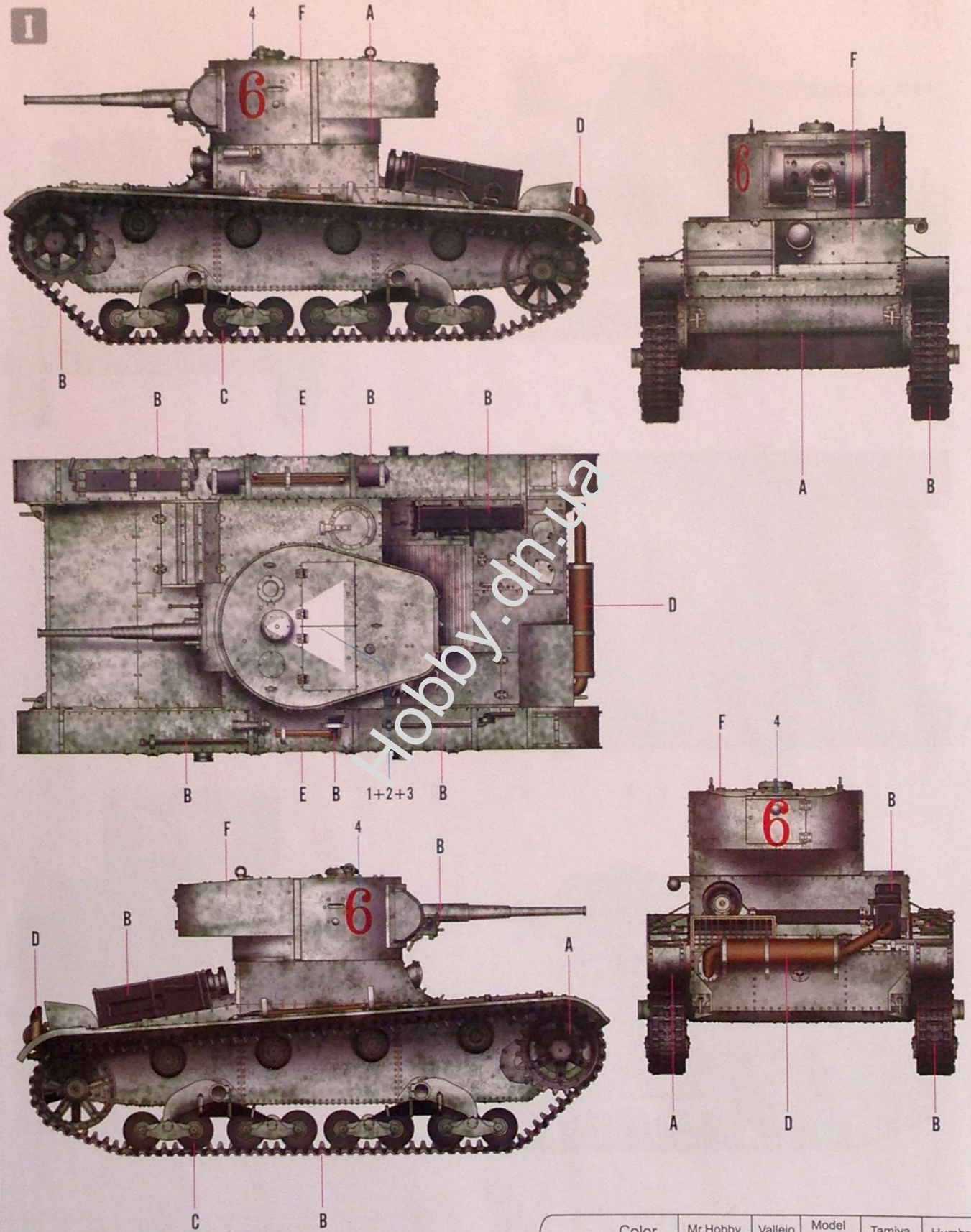

	Color	Mr.Hobby	Vallejo	Model Master	Tamiya	Humbrol
A	苏联绿 Russian Green(2)	H 136	823	--	--	--
B	黑铁色 Steel	H 18 28	864	1402	--	--
C	胎黑色 Tire Black	H 77 137	--	--	--	--

NO.:82495

Some paints may not be available in your country. Please check your local hobby shop for substitute

II

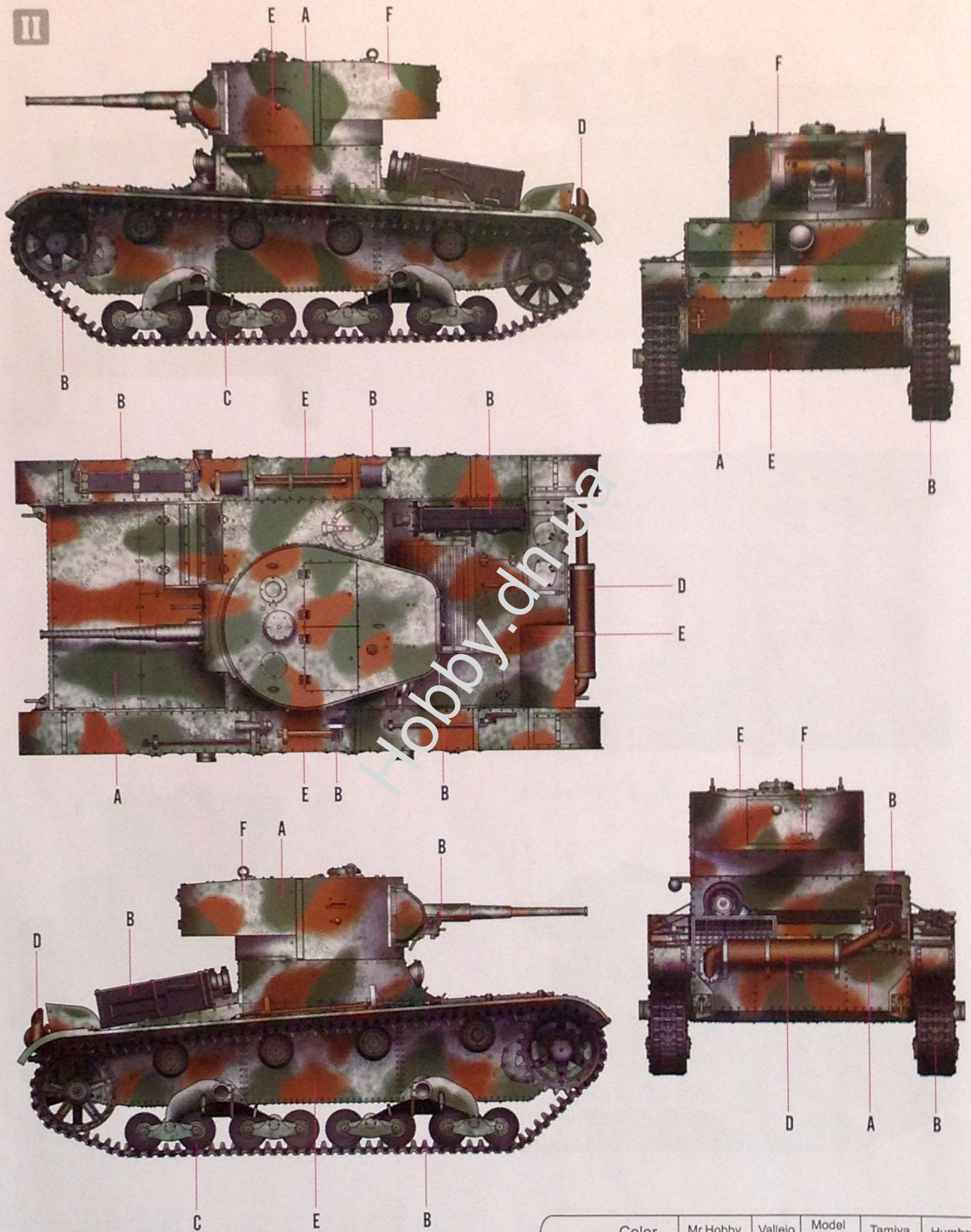

	Color	Mr Hobby	Vallejo	Model Master	Tamiya	Humbrol
D	烧铁色 Bare Iron	H 76 01	863	1795	X10	53
E	木棕色 Wood Brown	H 37 43	983	1701	--	186
F	哑光白 Flat White	H 11 02	951	1768	XF2	34

NO.:82495

\*Some paints may not be available in your country. Please check your local hobby shop for substitute