

# PZL.37 B II Łoś in Romanian Service

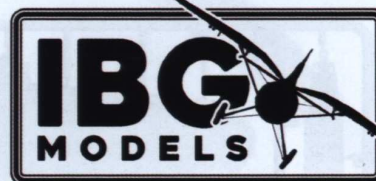

Cat. No. 72516  
Scale 1/72



3d design: Przemysław Głogowski  
Research: IBG Crew  
2d drawings: Maciej Noszczak

▲ 1 Element złożony we wcześniejszym etapie  
Element assembled in previous step

▲ 1 Element po złożeniu w aktualnym etapie  
Element after assembly in current step

▲ ? Wersja do wyboru  
Version to choose

▲ A Kolor farby  
Paint colour

▲ 1 Kalkomania  
Decal

Elementy Fototrawione / Photo-etched Parts

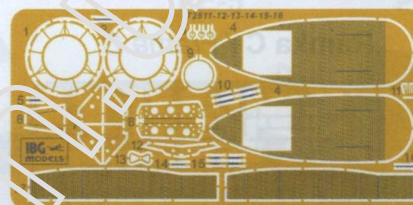

Kalkomanie / Decals

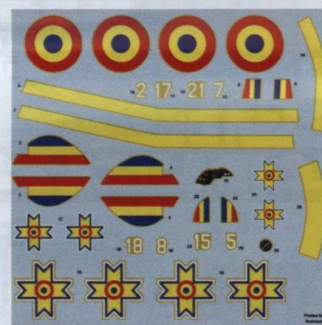

		VALLEJO MODEL AIR	HATAKA	LIFE COLOR	MR HOBBY	AK INTERACTIVE
Dark Earth	A	71.323	HTK-_009	UA547	H72	RC287
Black	B	71.073	HTK-_100	LC02	H12	RC001
White	C	71.001	HTK-_101	LC01	H21	AK738
Silver	D	71.067	HTK-_003	LC24	H8	AK479
Rust	E	71.130	HTK-_132	LC32	H47	AK708
Sky Blue	F	71.321	HTK-_234	UA550	C368	RC290
Dark Green	G	71.324	HTK-_143	UA546	H330	RC286

Przed montażem przeczytać instrukcję. Przestrzegać kolejności montażu podanego w instrukcji. Klej i farby nie wchodzi w skład zestawu.  
Please read instructions before assembly. Follow the sequence of assembly presented in instructions. Glue and paint not included.

IBG Models  
ul. Benedykta Hertza 2  
04-603 Warszawa  
Poland

tel +48 22 8159150  
fax +48 22 8159151  
ibgsc@ibg.com.pl  
www.ibg.com.pl  
www.ibgmodels.com



**Elementy modelu**

*Elements of the model kit*

**Ramka A / Frame A**

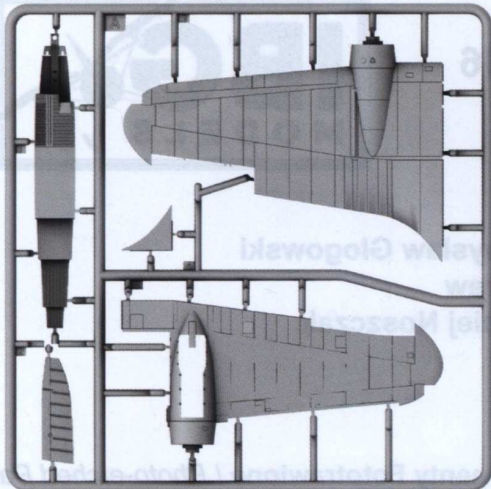

**Ramka B / Frame B**

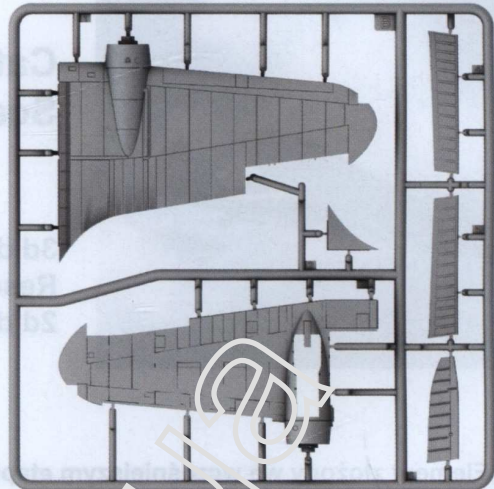

**Ramka C / Frame C**

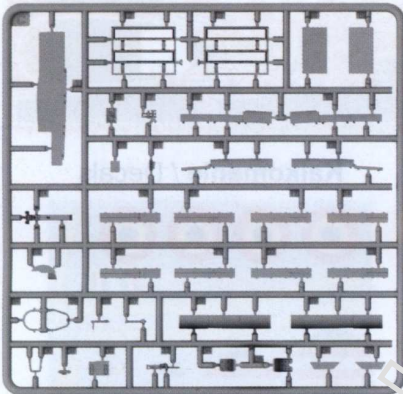

**Ramka E x2 / Frame E x2**

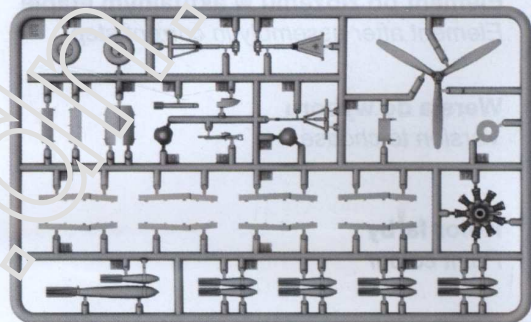

**Ramka H / Frame H**

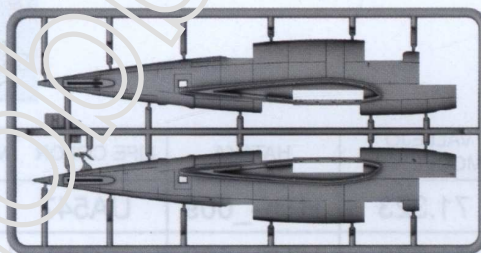

**Ramka J / Frame J**

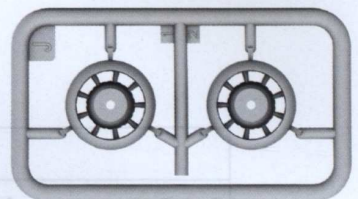

**Ramka D / Frame D**

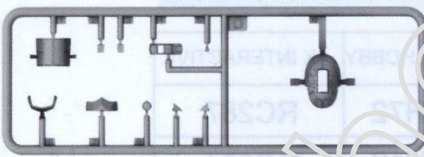

**Ramka Q / Frame Q**

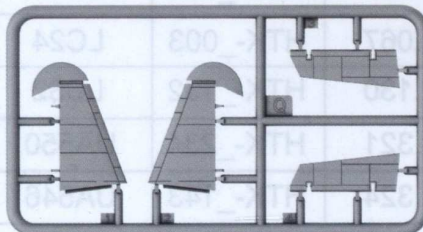

**Ramka K / Frame K**

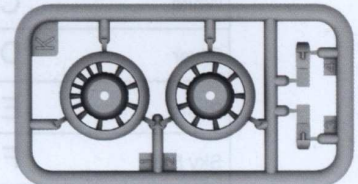

**Ramka R / Frame R**

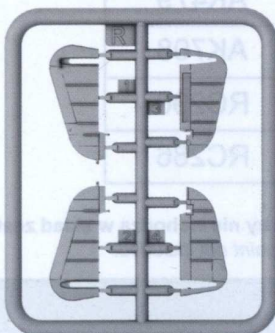

**Ramka M / Frame M**

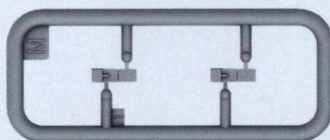

**Ramka T / Frame T**

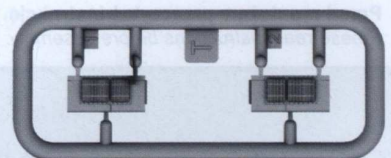



**Etap 1**  
Step 1

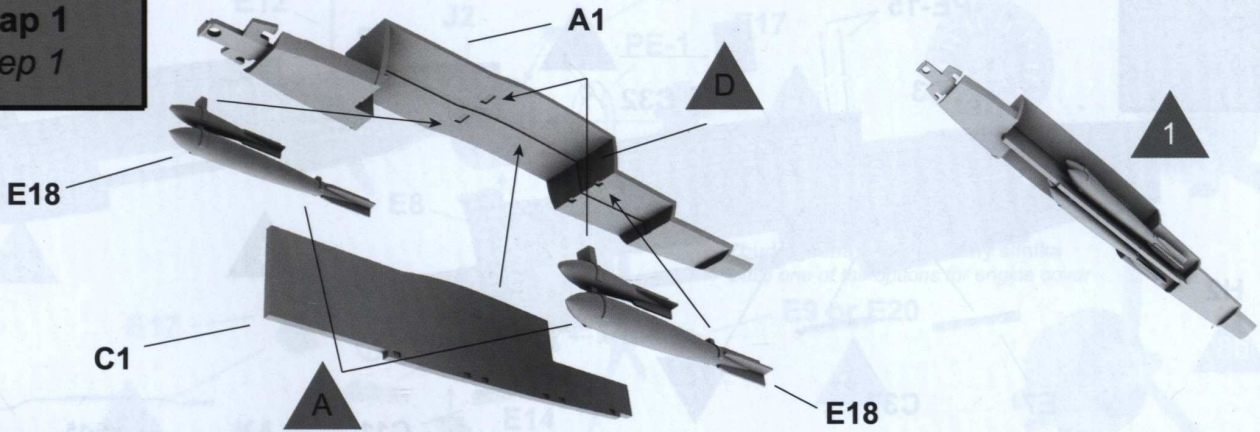

**Etap 2**  
Step 2

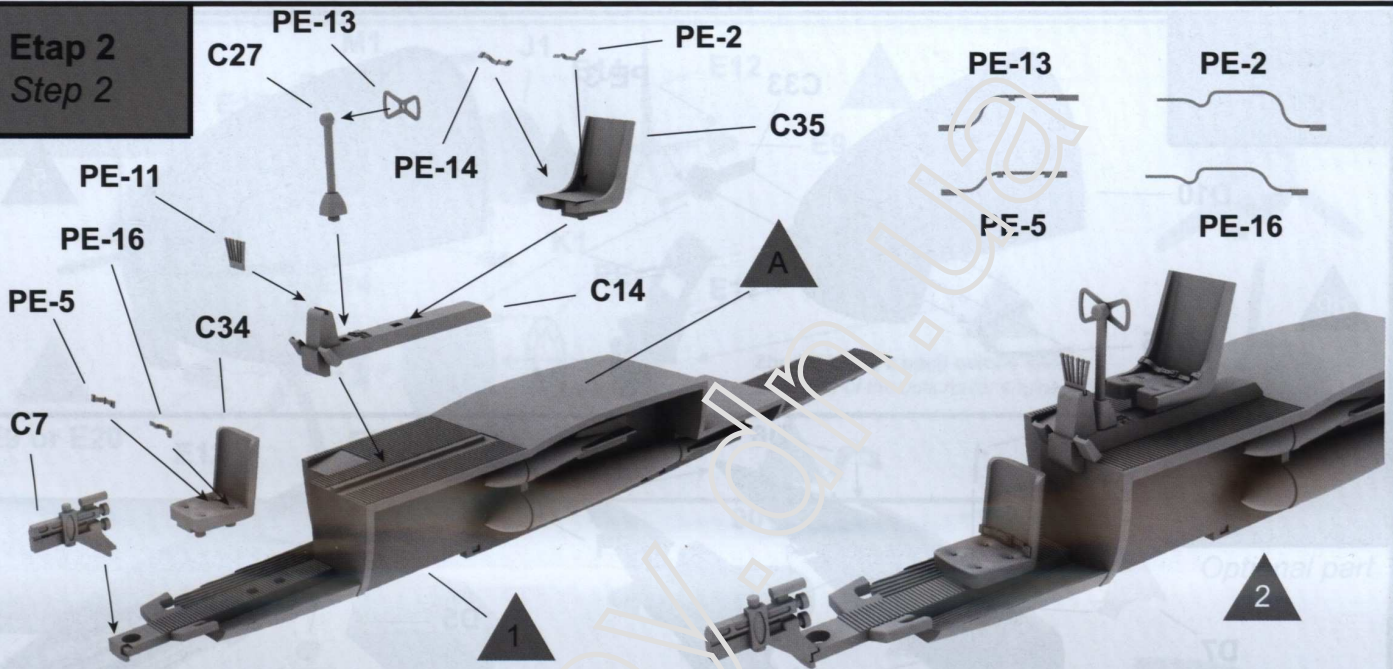

**Etap 3**  
Step 3

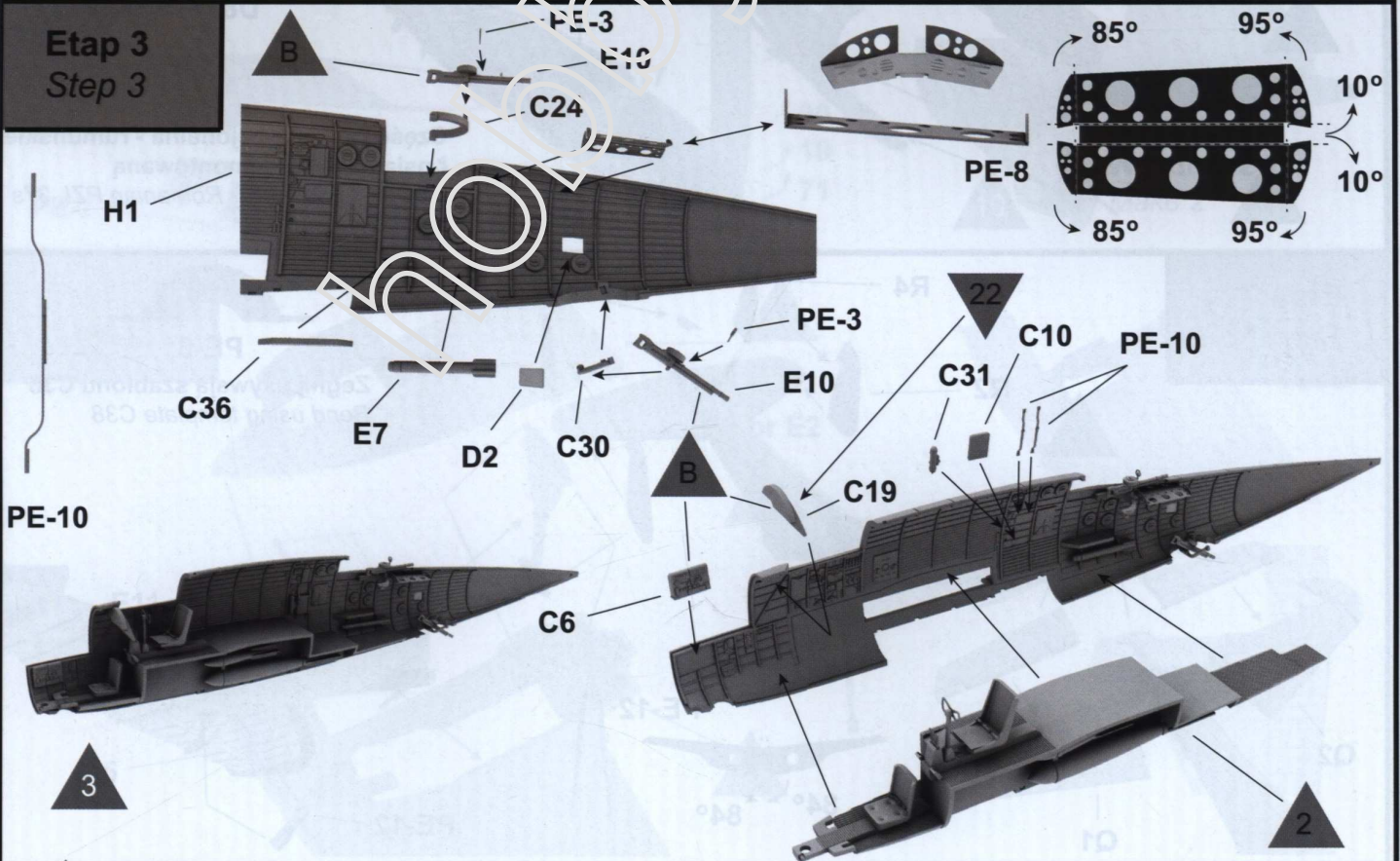



**Etap 4**  
*Step 4*

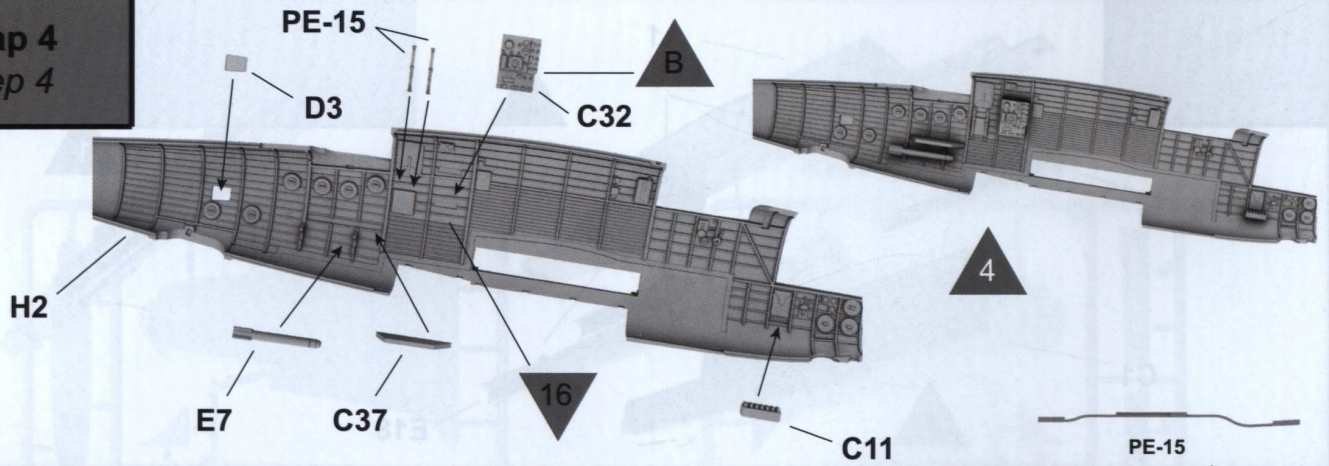

**Etap 5**  
*Step 5*

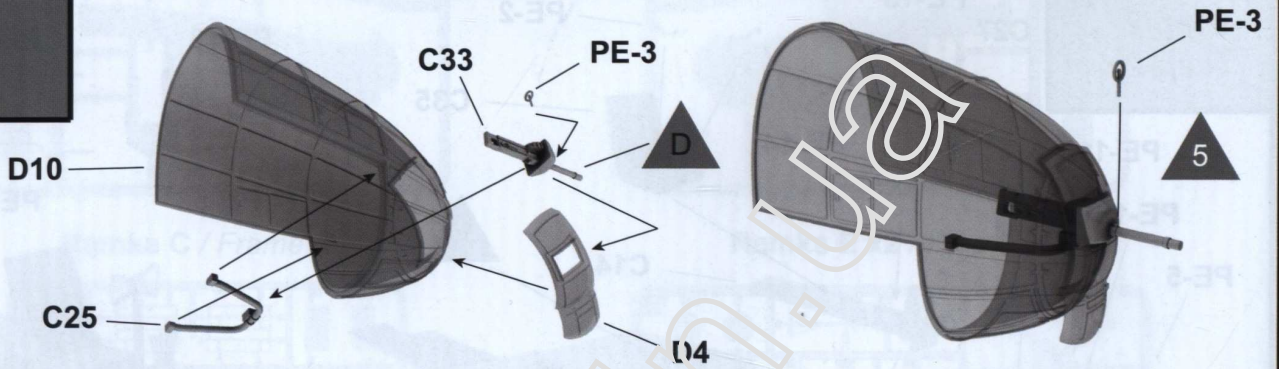

**Etap 6**  
*Step 6*

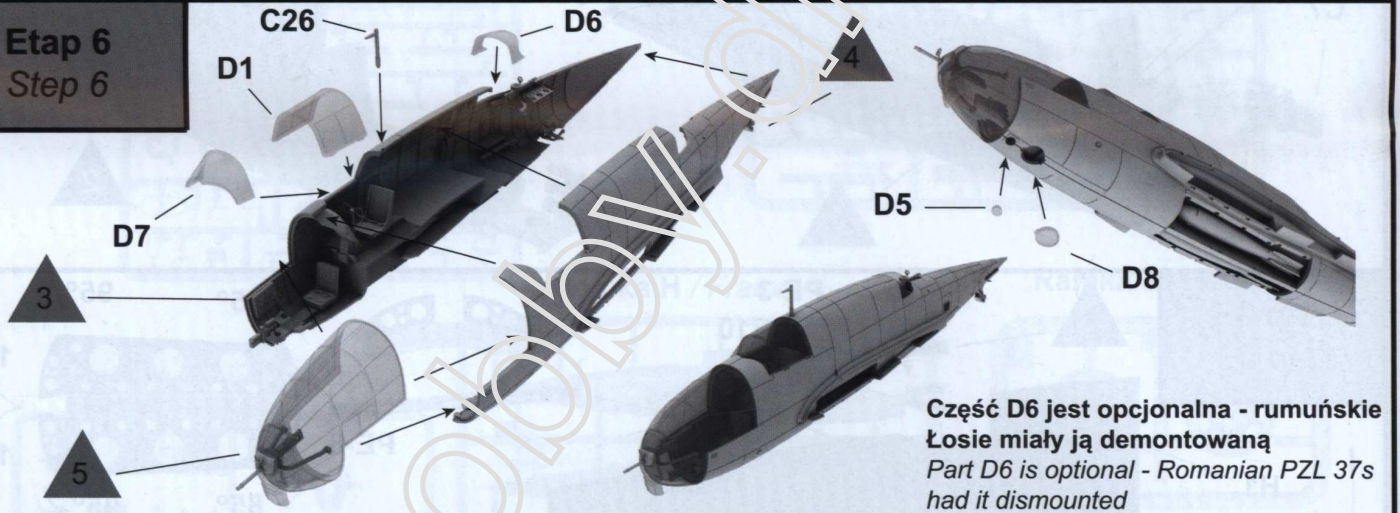

**Etap 7**  
*Step 7*

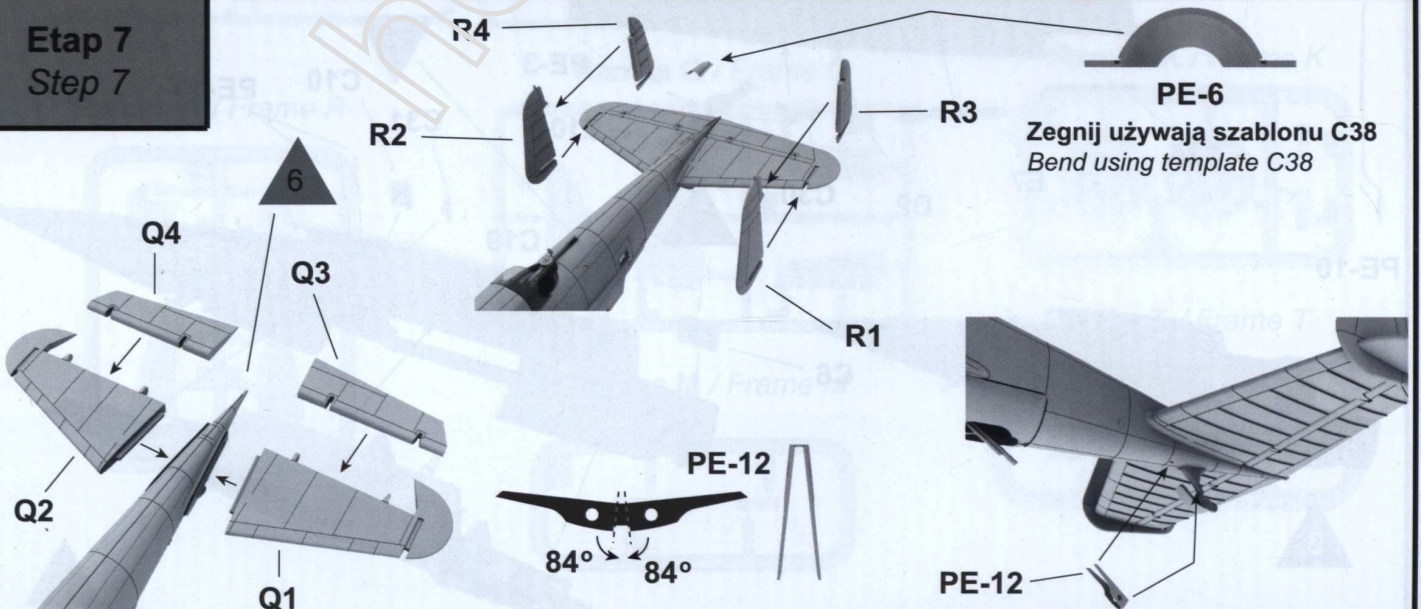



**Etap 8**  
*Step 8*

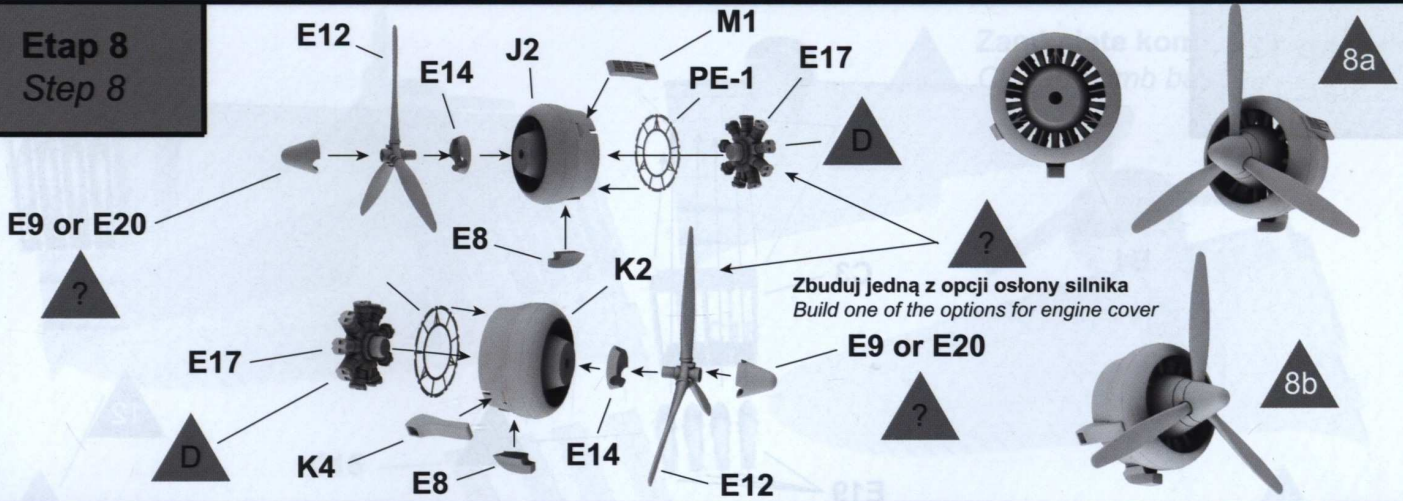

**Etap 9**  
*Step 9*

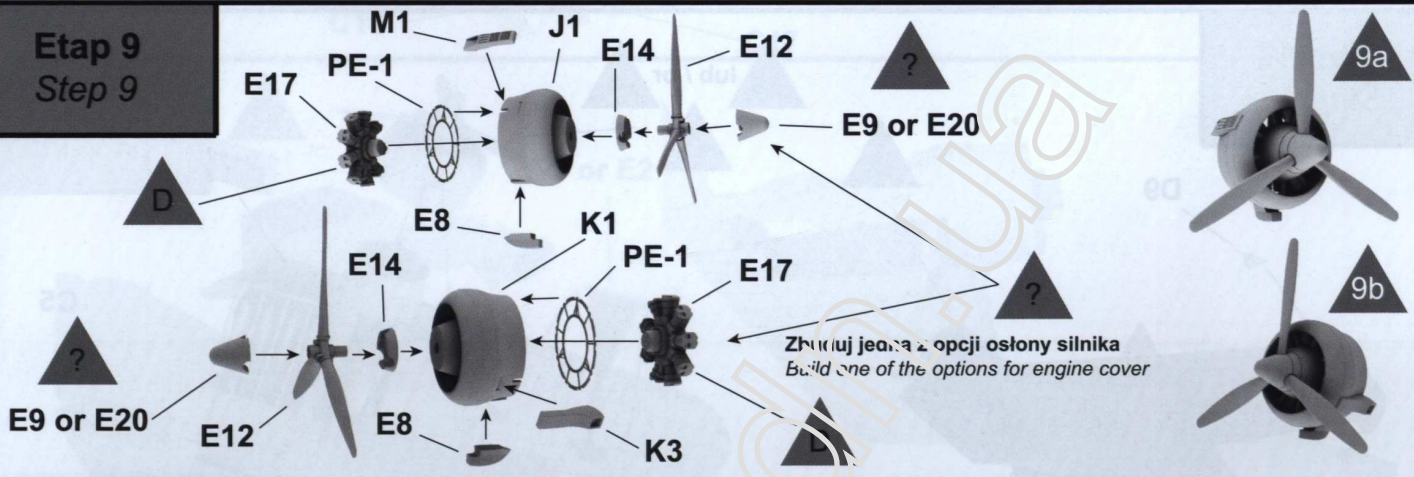

**Etap 10**  
*Step 10*

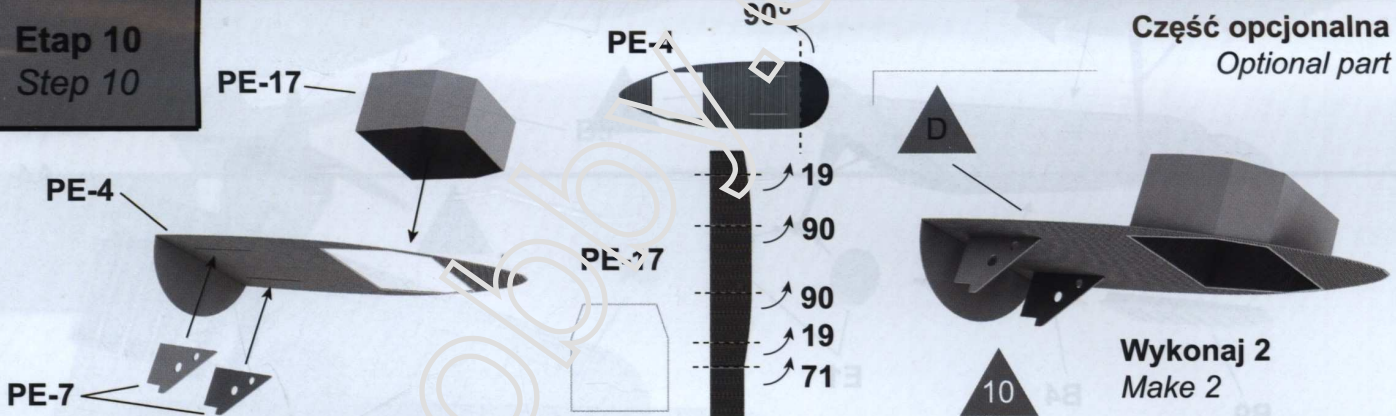

**Etap 11**  
*Step 11*

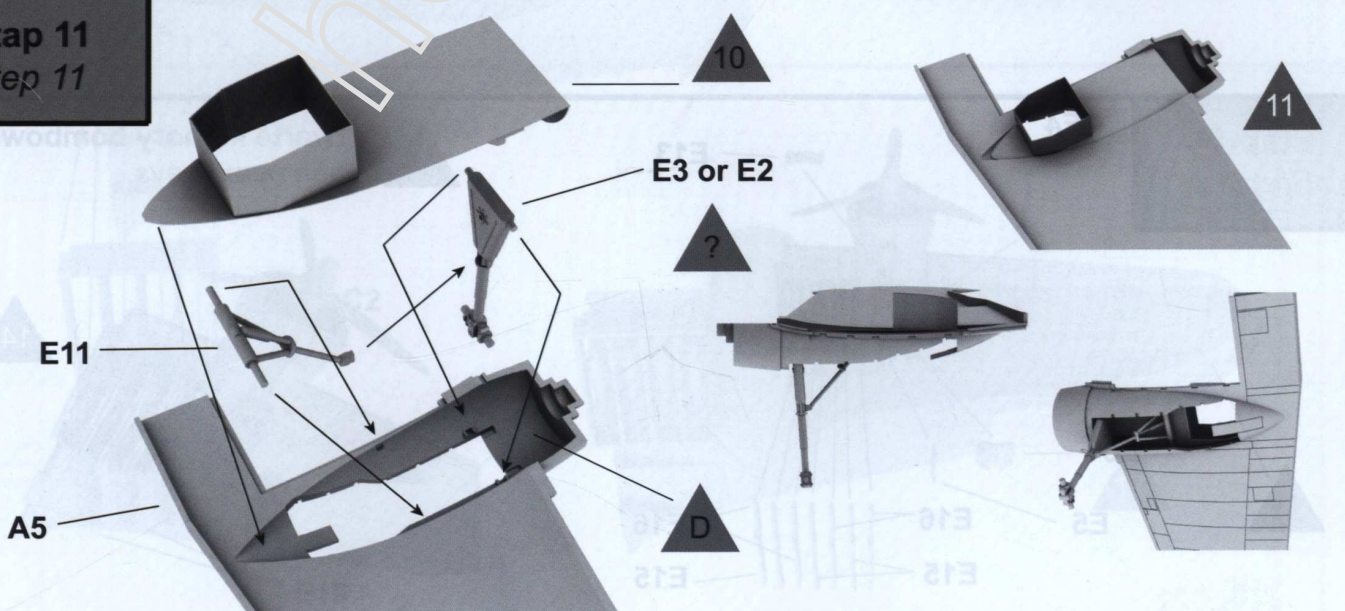



**Etap 12**  
Step 12

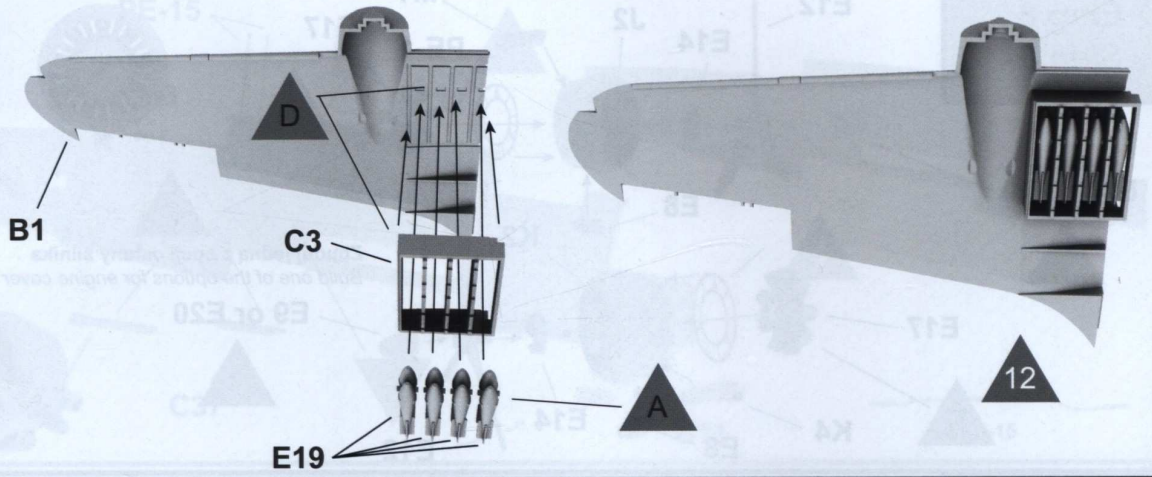

**Etap 13**  
Step 13

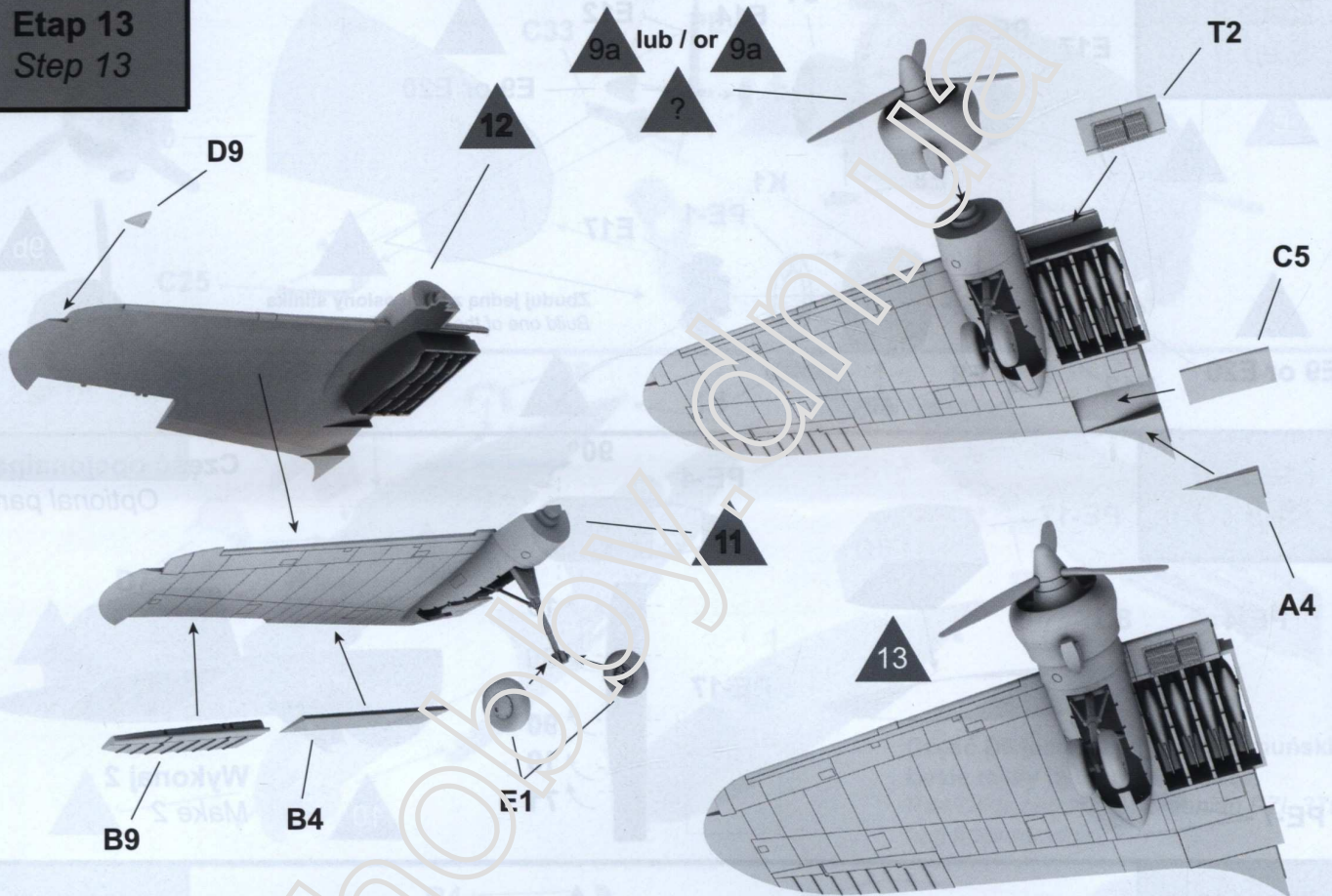

**Etap 14**  
Step 14

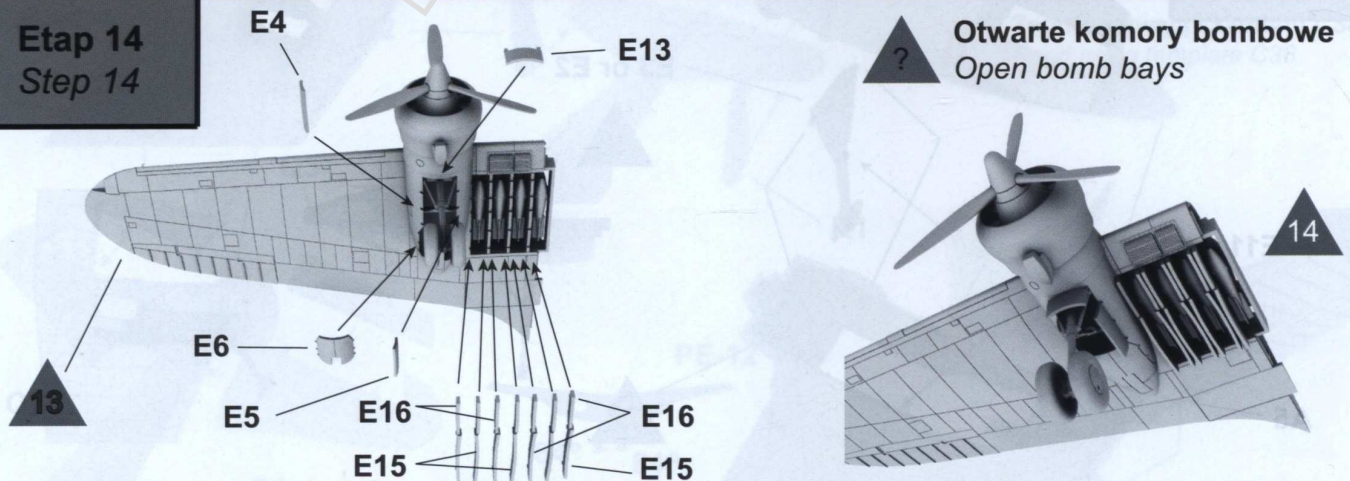



**Etap 15**  
*Step 15*

**Zamknięte komory bombowe**  
*Closed bomb bays*

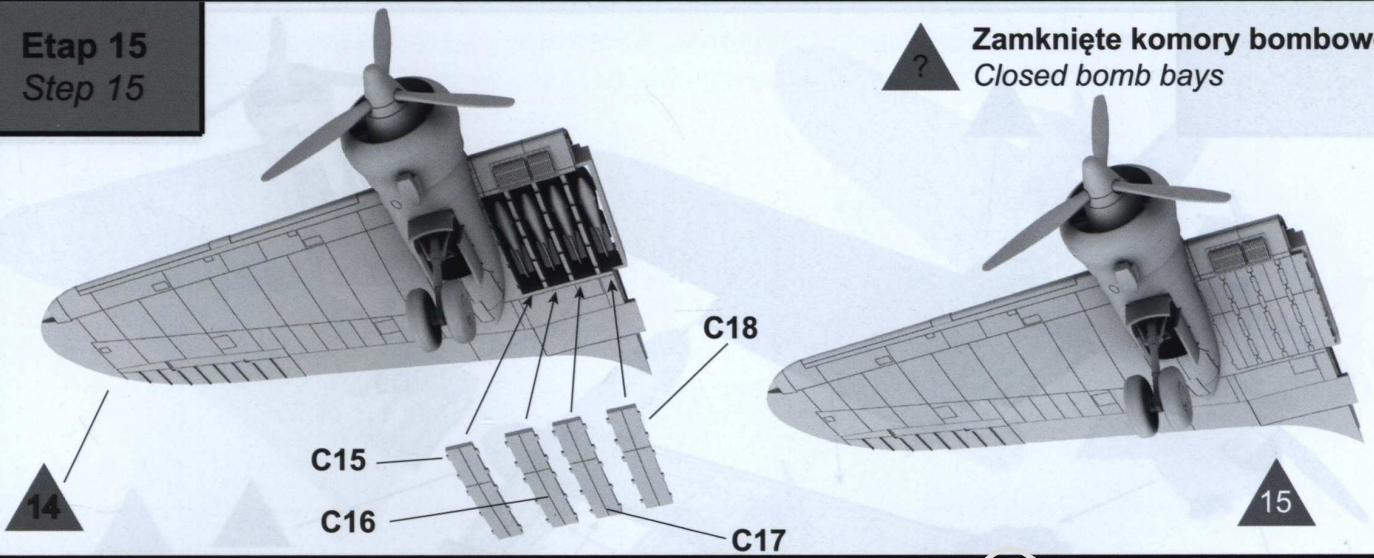

**Etap 16**  
*Step 16*

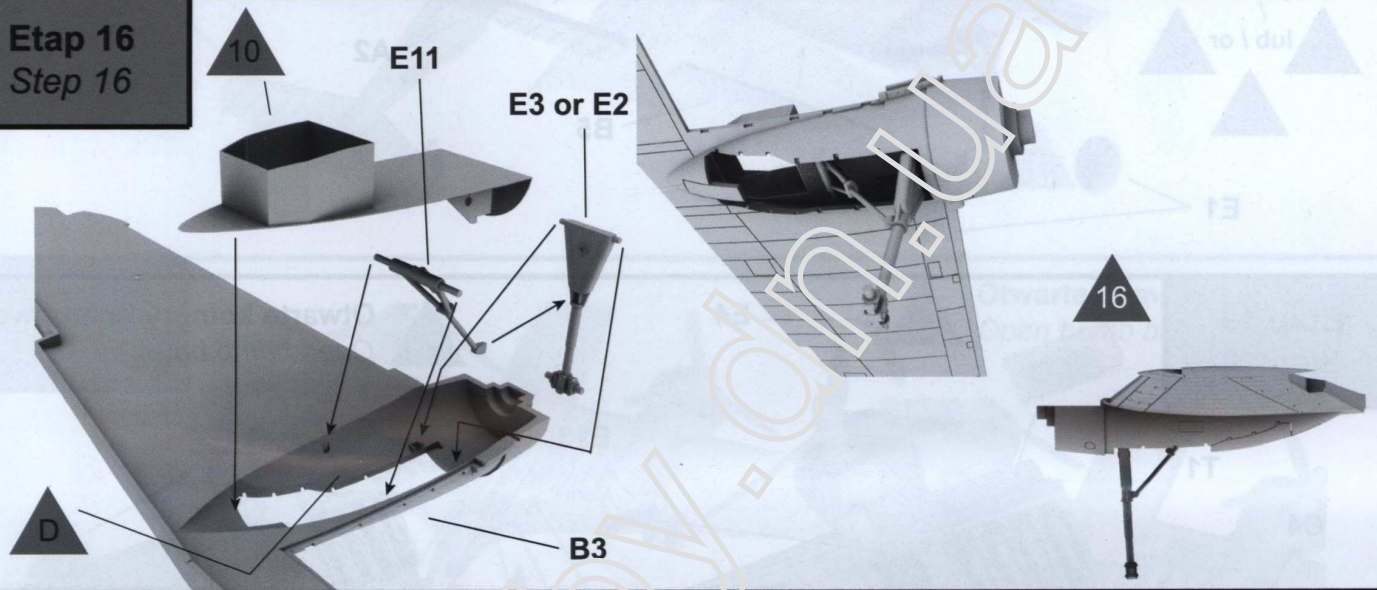

**Etap 17**  
*Step 17*

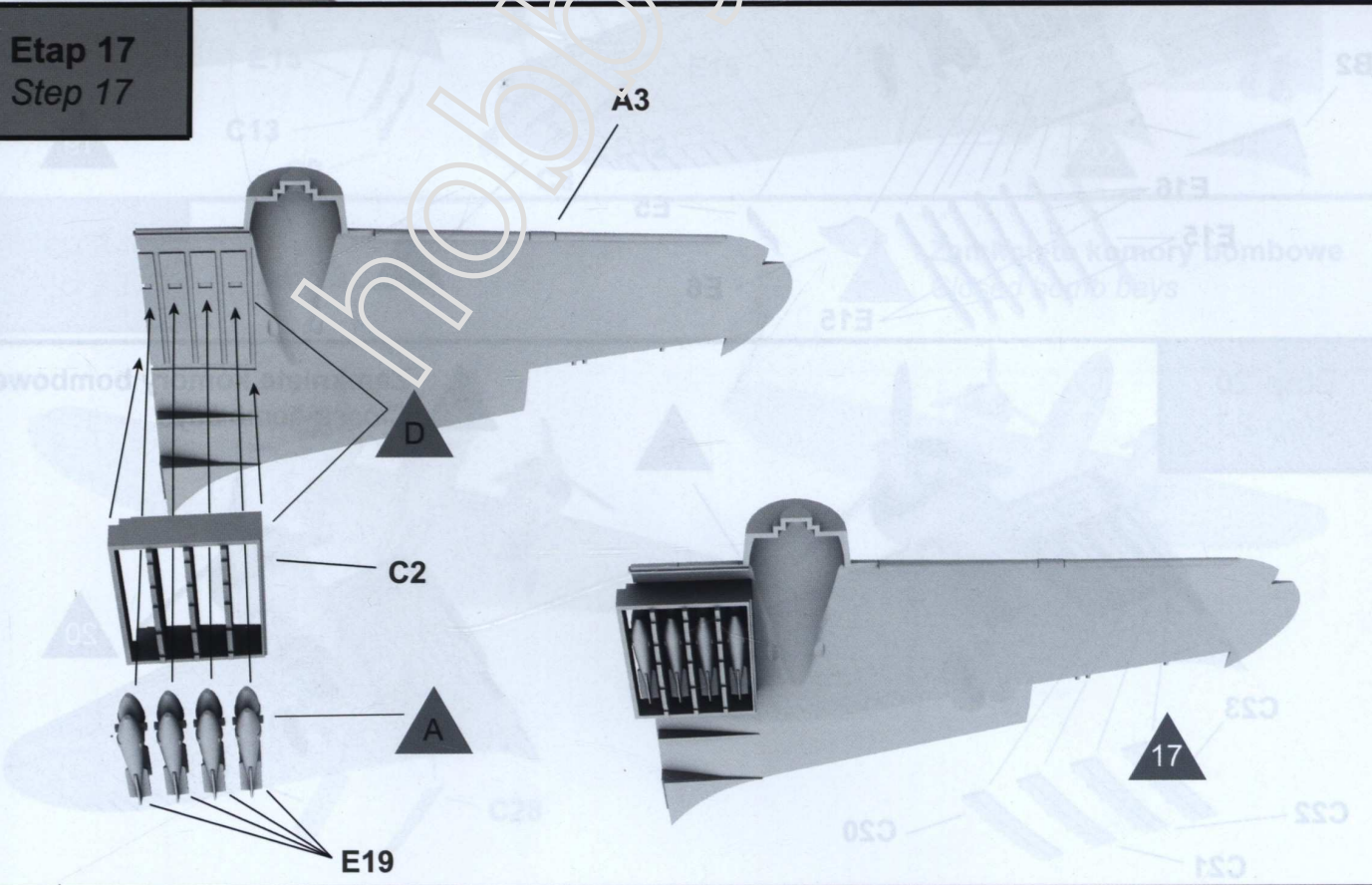



**Etap 18**  
*Step 18*

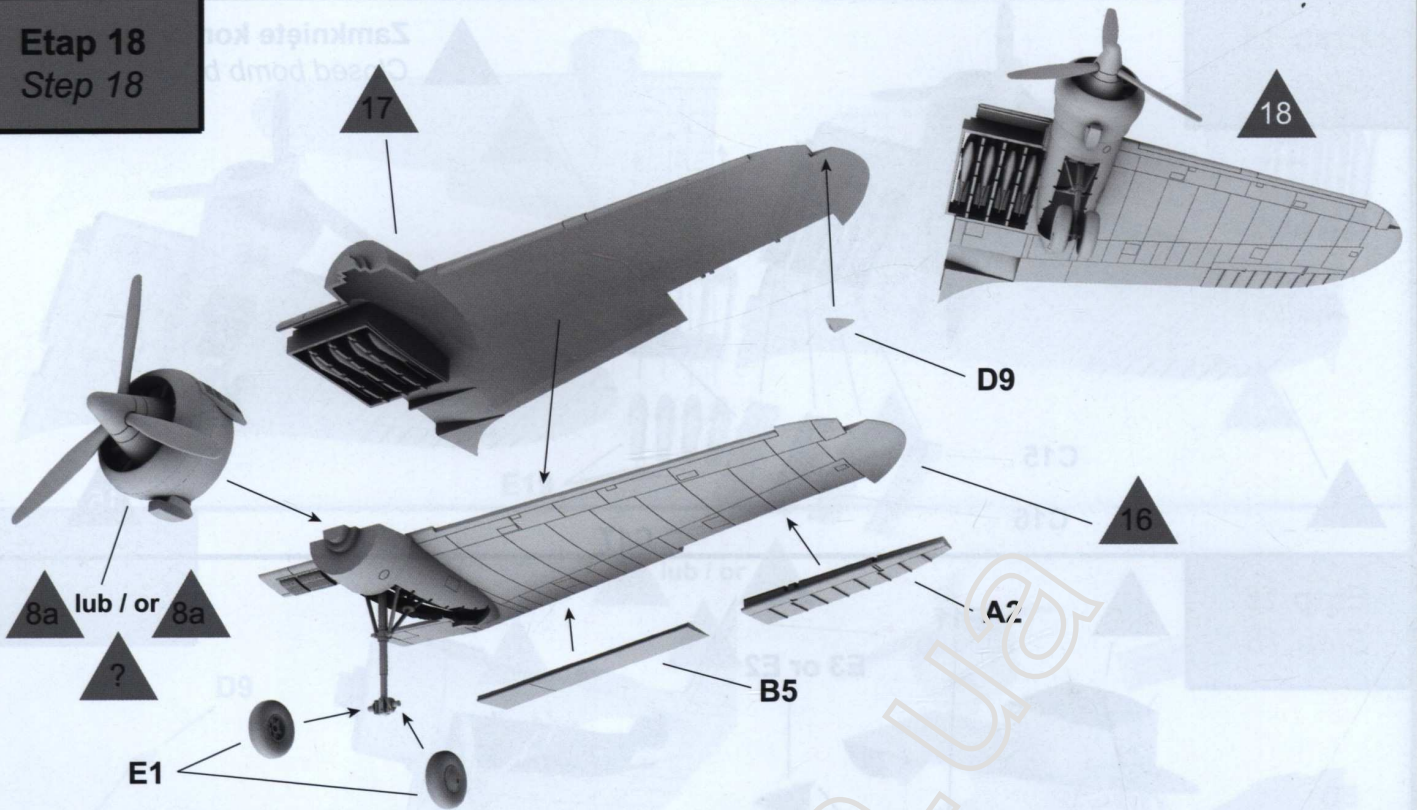

**Etap 19**  
*Step 19*

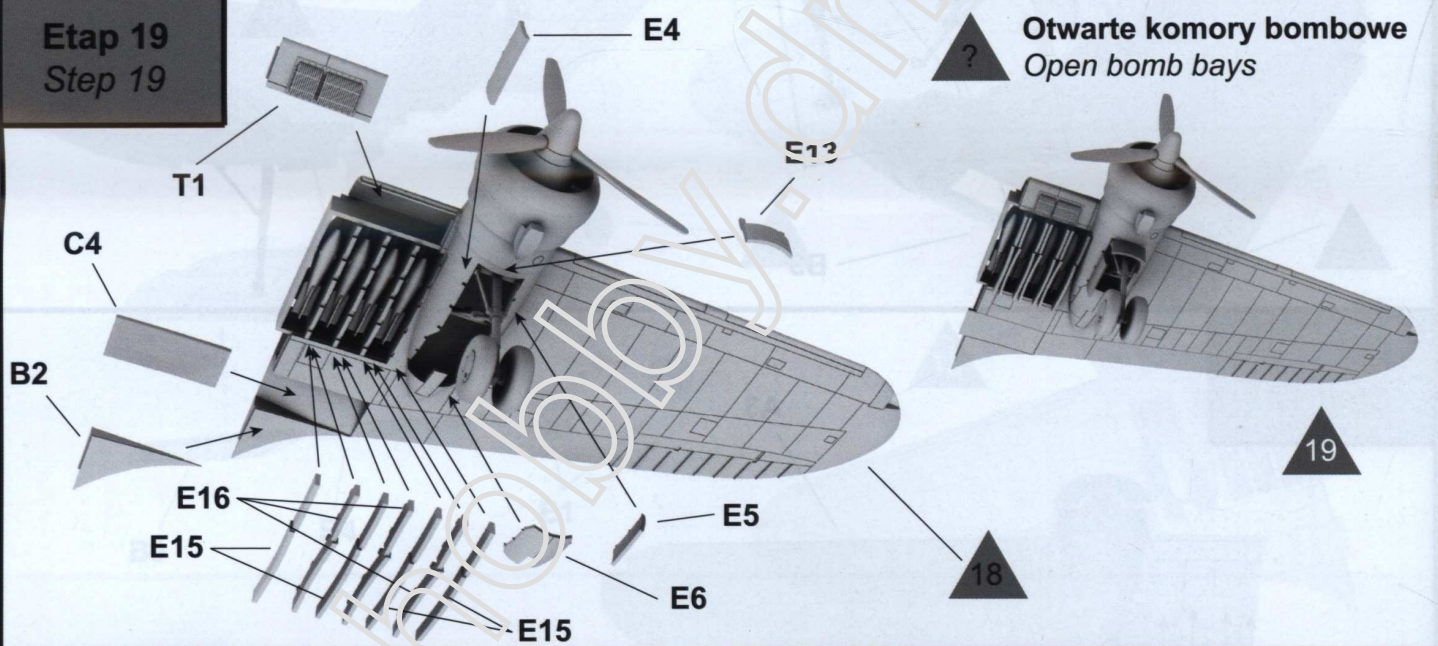

**Etap 20**  
*Step 20*

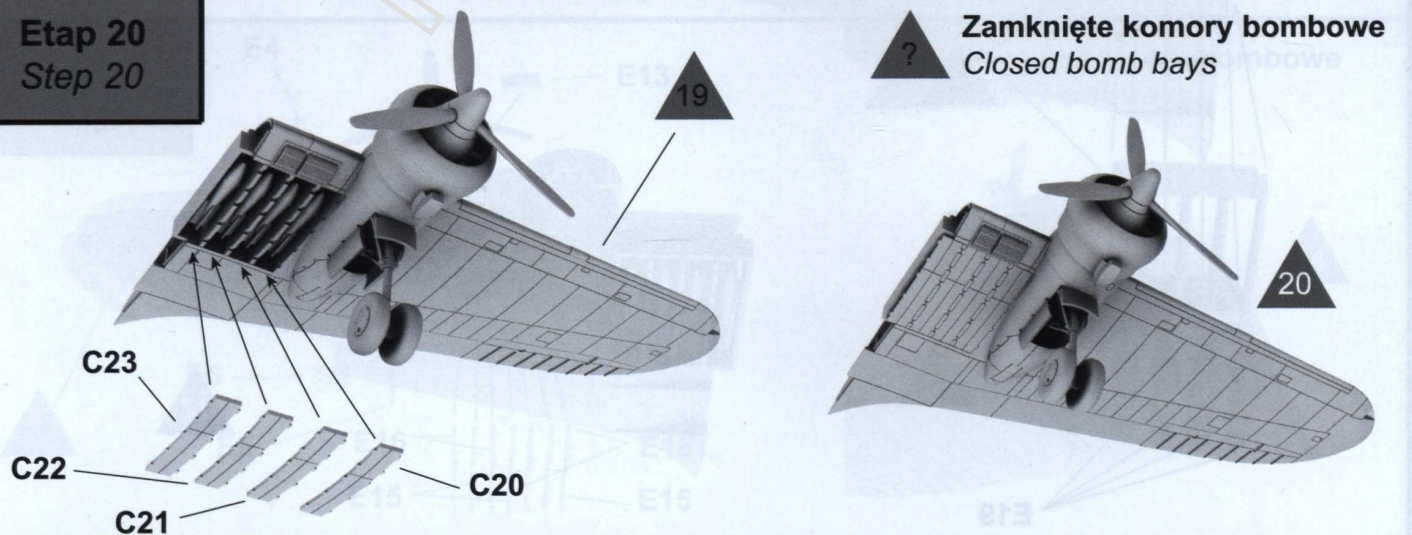



**Etap 21**  
*Step 21*

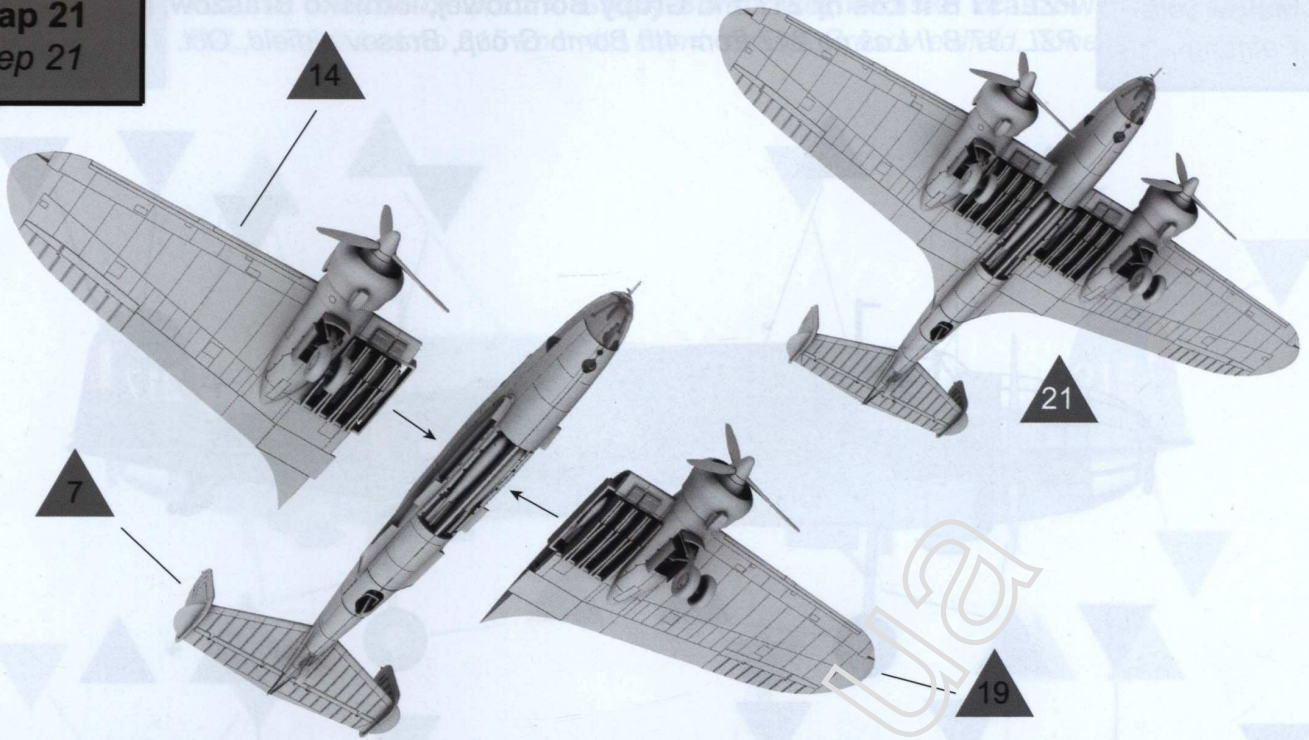

**Etap 22**  
*Step 22*

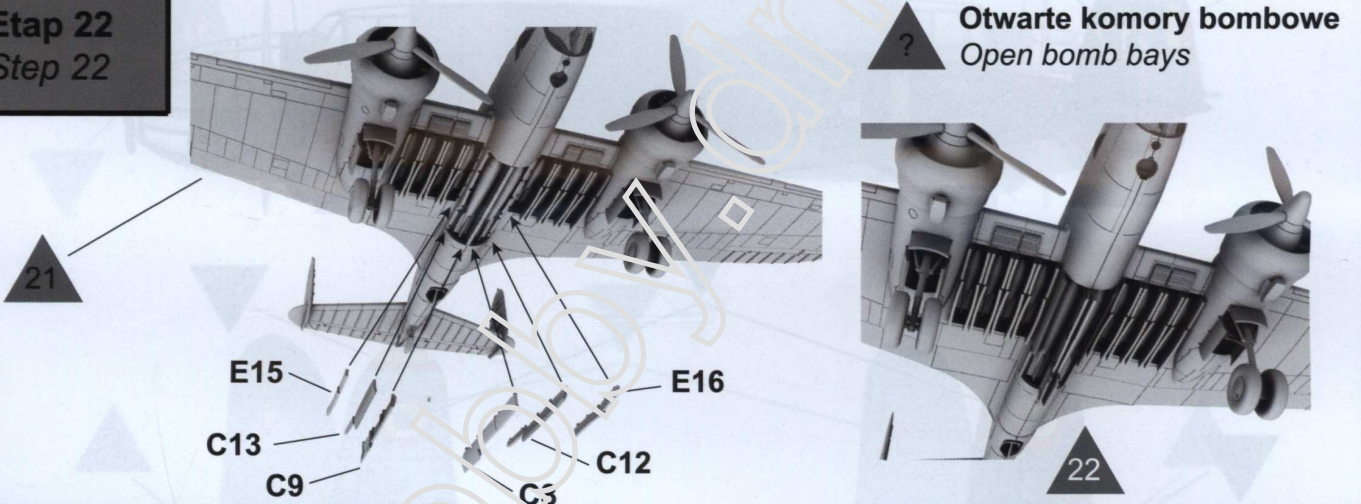

**Etap 23**  
*Step 23*

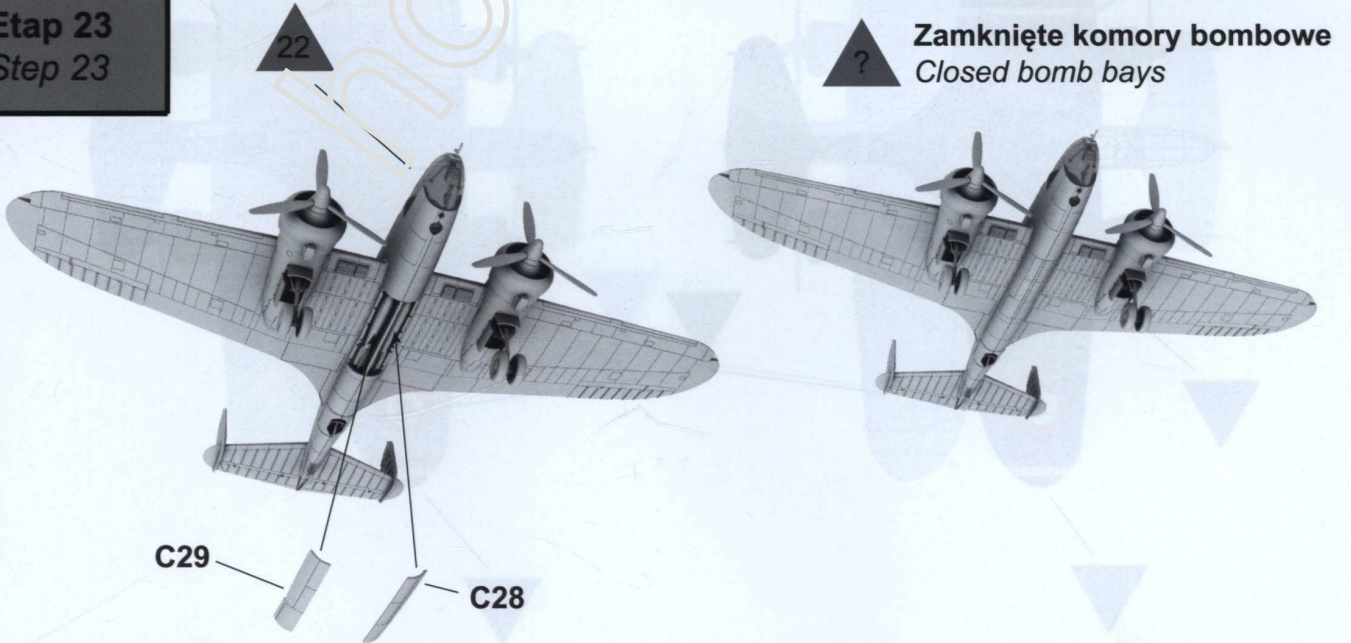



Malowanie  
Painting

PZL. 37 B II Łoś nr 217 z 4. Grupy Bombowej, lotnisko Braszow, paź. 1940 r.  
PZL. 37 B II Łoś no 217 from 4th Bomb Group, Brasov airfield, Oct. 1940.

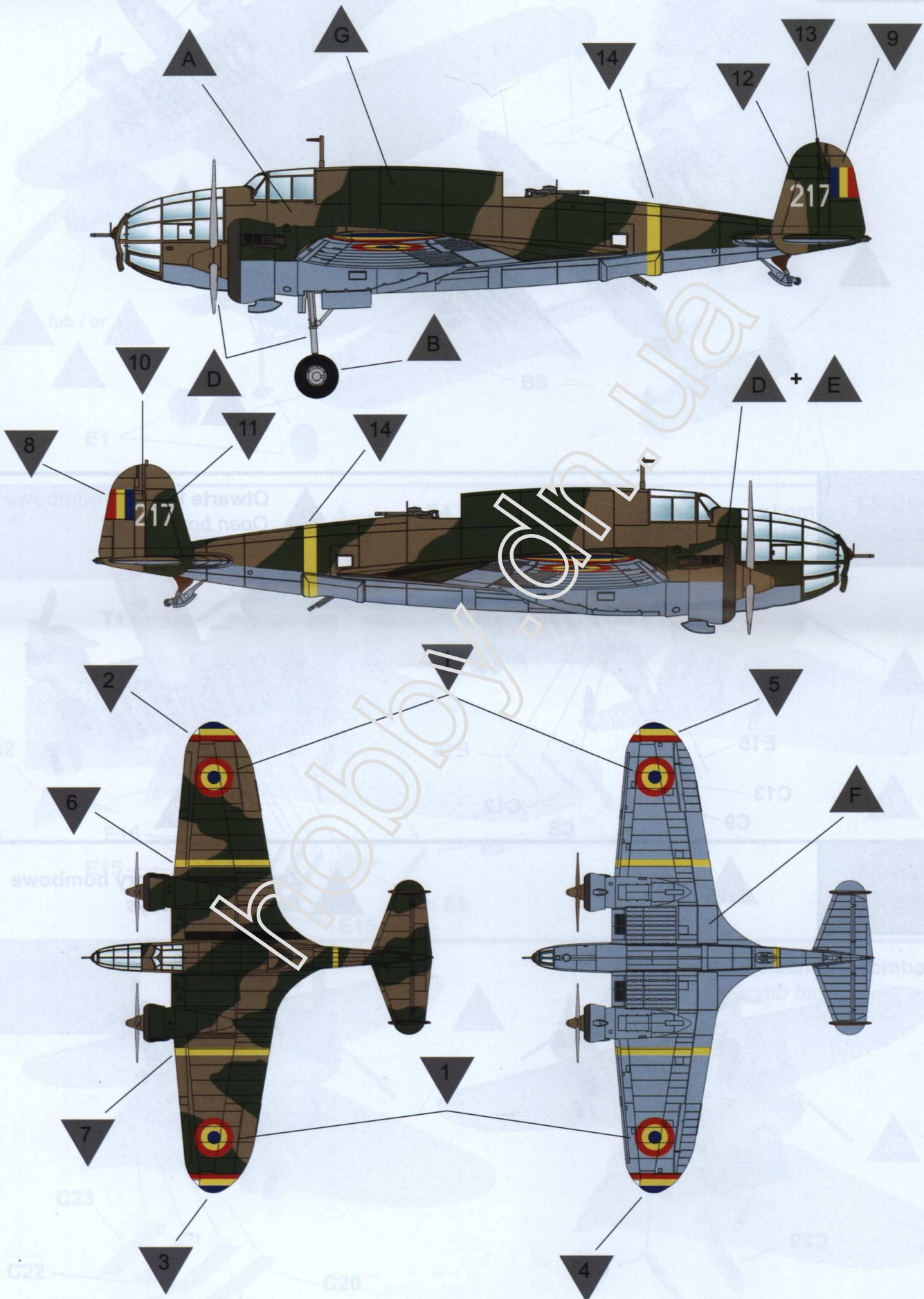







**Malowanie**  
*Painting*

**PZL. 37 B II Łoś nr 218 z 4. Grupy Bombowej, lotnisko Stalpu, czerwiec 1941 r.**  
*PZL. 37 B II Łoś no 218 from 4th Bomb Group., Stalpu airfield, June 1941.*

