

1:72 SCALE

IBG
MODELS
72906

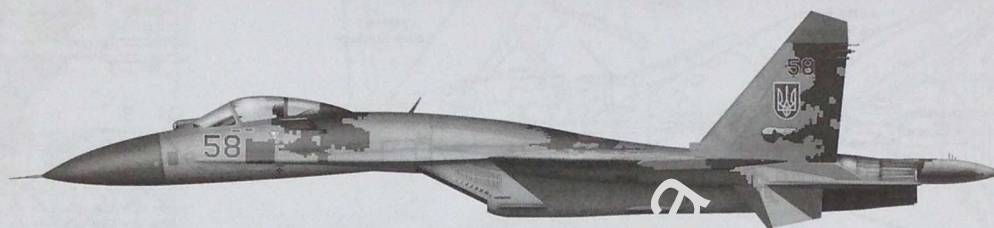

Su-27 Flanker Fighter

READ BEFORE ASSEMBLY:

- Study and understand these instructions thoroughly before beginning assembly
- When needed, remove photo-etch parts carefully using a modeling knife or photo etch sprue cutter, being careful not to damage or lose small parts.
- Take extra care in handling photo etch parts in order to avoid injury
- Apply instant cement sparingly to photo etch parts where instructed

- Tools recommended (not included in kit): Plastic and instant cements, sprue cutters, long nose pliers, modeling knife, small files, tweezers, pin vise & scissors. Soft cloth and sandpaper will also assist in construction
- Glue and paint are not included in the kit. Use plastic cement and hobby paints only. Color guide for purchasing paints is included in the kit.

装配之前仔细阅读

- 小心用模型锉刀锉平所有零件表面的注射浇口。
- 小心用刀片切下蚀刻片零件，不要遗失小零件。
- 用强力快干胶水粘合蚀刻片零件和金属轴。过量快干胶水使用可能导致可动零件会粘住，小心涂胶。
- 取蚀刻片时应特别注意安全，防止利边划伤手指。
- 某些零件表面需贴水上贴纸，请选择在装配的同时进行。
- 推荐模型工具(自备)：胶水，水口剪刀，长阻钳，刀片，锉刀，镊子，钳，钻，剪刀，瞬间快干胶。
- 软布同砂纸同时也应该是必备工具。
- 请使用塑料胶水和油漆，模型内不含。

水贴纸的使用:

1. 从水贴纸上剪下印花;
2. 将印花放入温水中浸10秒, 然后放在干净布上;
3. 拿着印花纸板将印花移到模型上;
4. 手指蘸水将印花移到适当的位置;
5. 用软布轻压印花直至水干, 汽泡消失。

DECAL APPLICATION:

1. Cut decals from sheet as needed
2. Dip the decal in warm water for about 10 seconds and then place on soft clean cloth.
3. Hold the decal backing sheet edge and gently slide the decal onto the model in its proper position.

4. While still wet, decal can be adjusted for better fit on model by dampening it gently with your finger.
5. When placed in the proper position, gently press decal down with a soft cloth until excess water and air bubbles are gone
6. Allow decal to dry completely before handling model



cyanocrylate glue
使用强力胶



weight
配置



make hole
钻孔



cut / remove
切除



option
选择



no cement
不涂胶水



decal
贴纸



bend
弯曲



file / sand
锉平

部品图
Parts



《上部机身》
Top fuselage

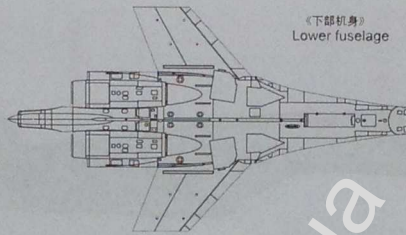

《下部机身》
Lower fuselage

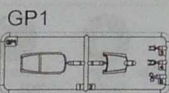
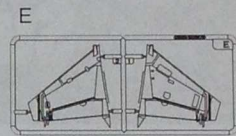
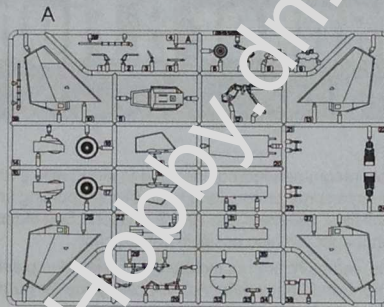
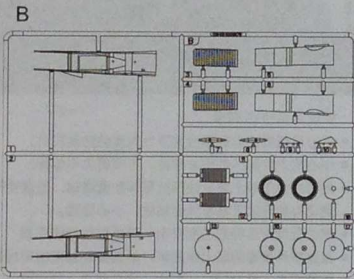
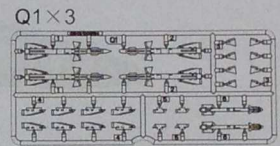
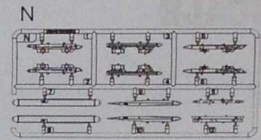

不用的零件 A9 A10 A25 A32 A39 GP4
Unused parts

Decals

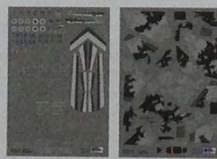

| | | Hataka Hobby | Vallejo | AK Interactive |
|--------------|---|-----------------|---------|-------------------|
| Traffic Blue | A | HTK_ 220 | 70.809 | RC010 |
| Sky Blue | B | HTK_ 320 | 70.844 | RC291 |
| Light Blue | C | HTK_ 321 | 70.841 | RC239 |
| Window Grey | D | HTK_ 334 | 71.050 | RC261 |
| Mouse Grey | E | HTK_ 335 | 71.259 | RC279 |
| Dusty Grey | F | HTK_ 249 | 71.047 | RC215 |
| Black | G | HTK_ 041 | 71.057 | RC082 |
| Satin White | H | HTK_ 101 | 71.001 | RC004 |
| Red | I | HTK_ 276 | 71.003 | RC006 |
| Gunmetal | J | HTK_ 106 | 70.863 | RC015 |
| Silver | K | HTK_ 003 | 71.067 | RC020 |
| Cockpit | L | HTK_ 314 | 71.101 | RC280 |

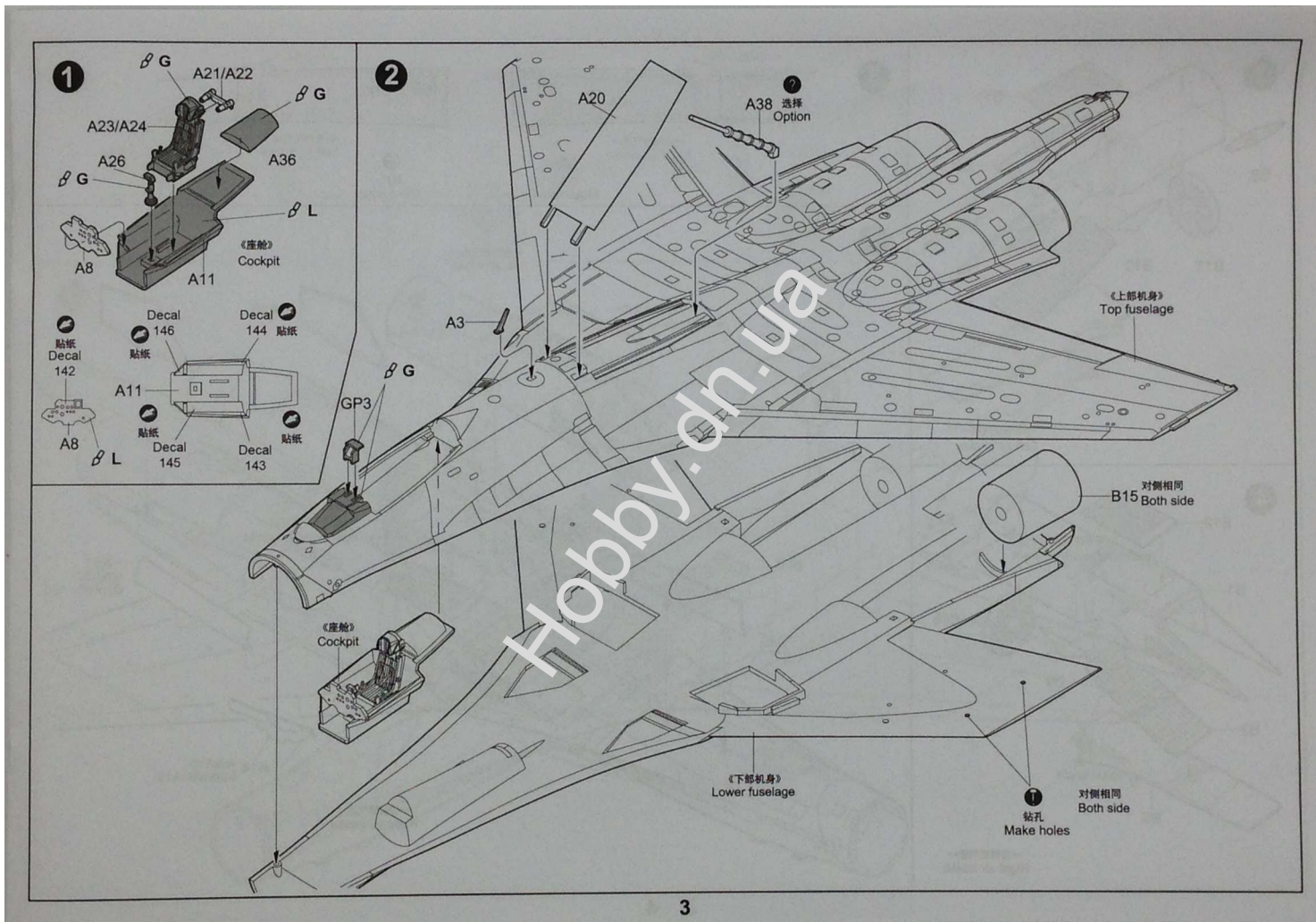

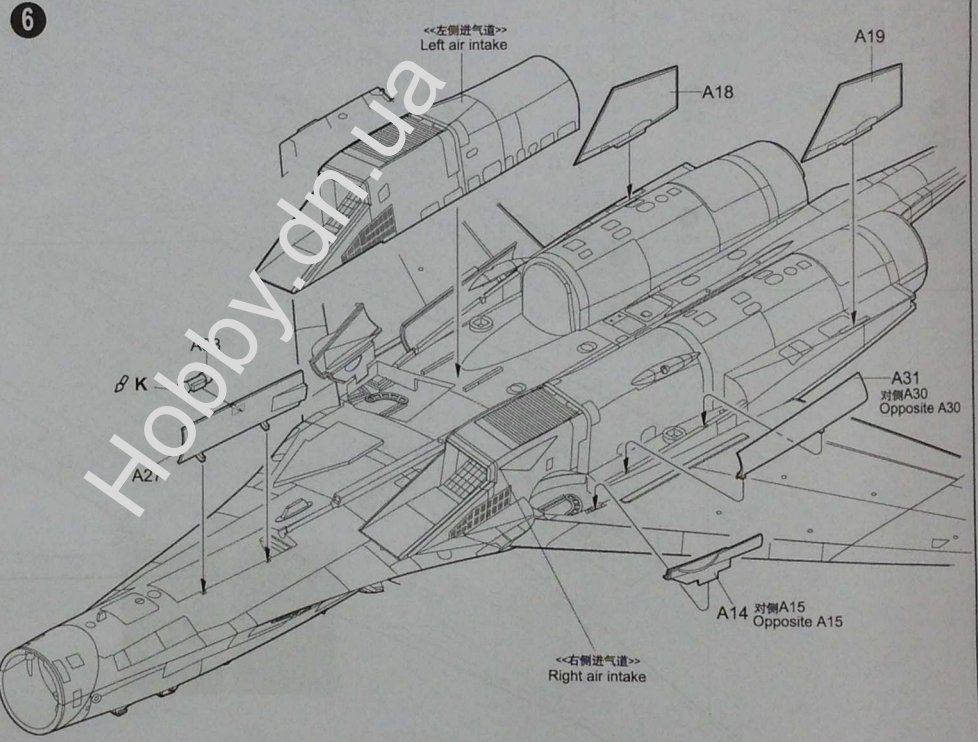
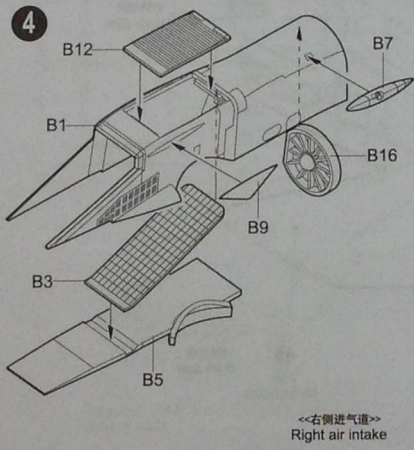
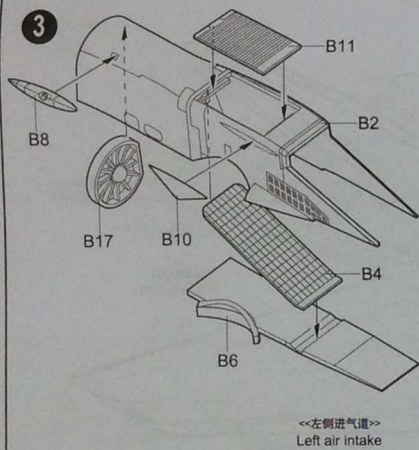

7

<<前起落架>>
Nose undercarriage

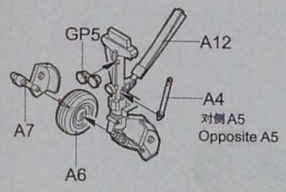

8

<<左侧主起落架>>
Left main undercarriage

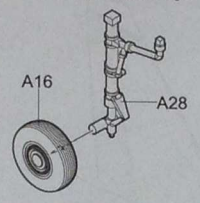

<<右侧主起落架>>
Right main undercarriage

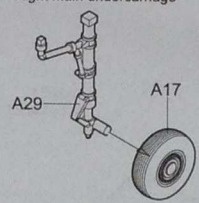

9

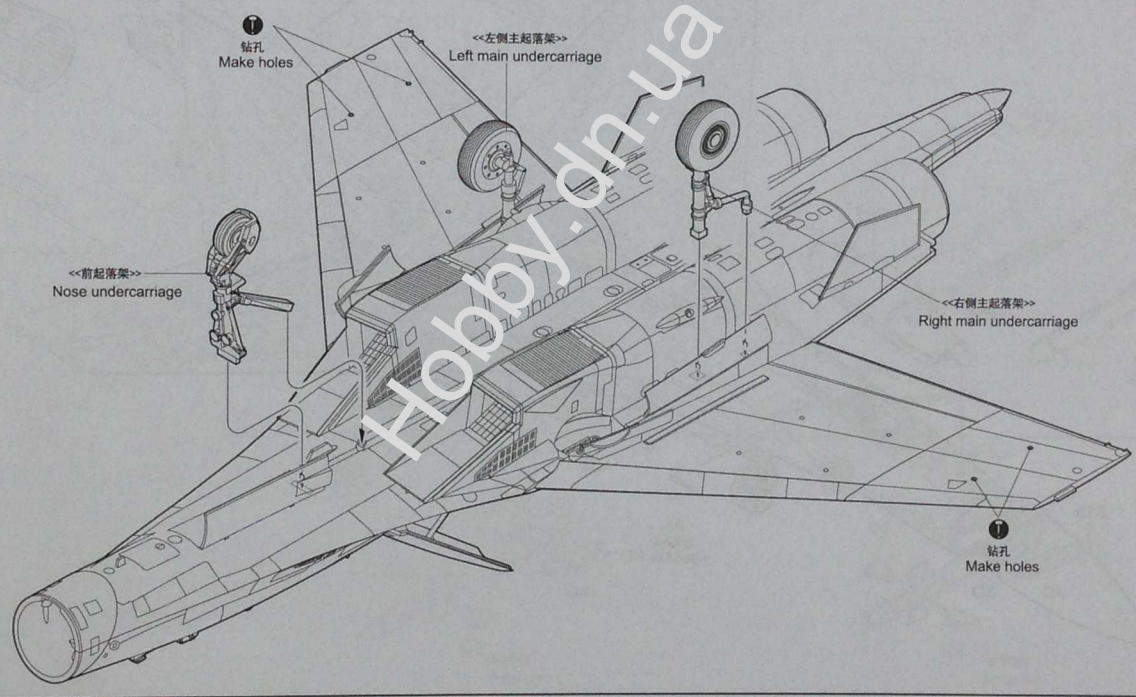

10

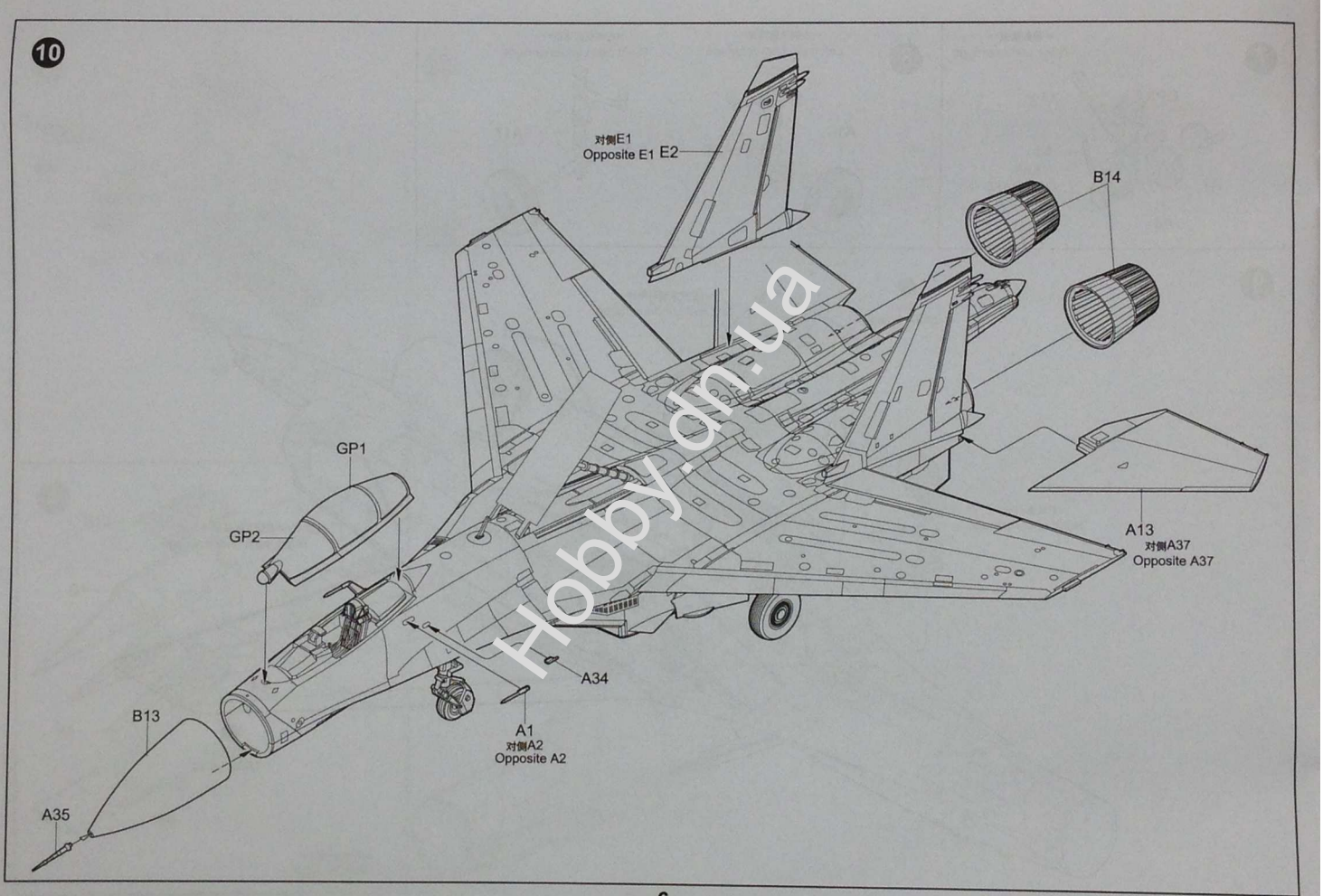

11

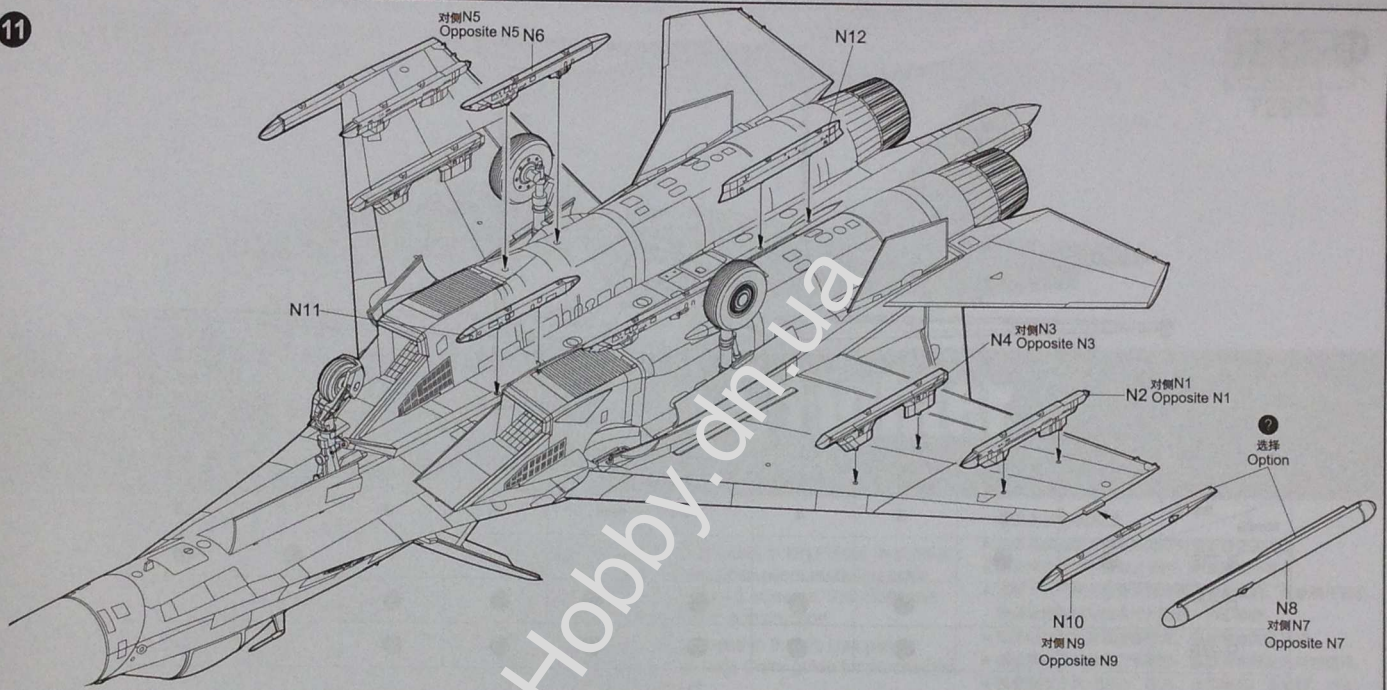

12

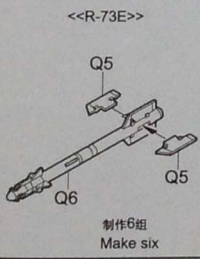

13

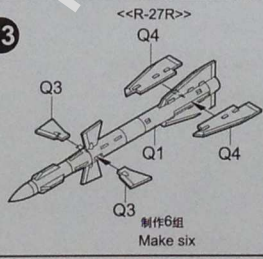

14

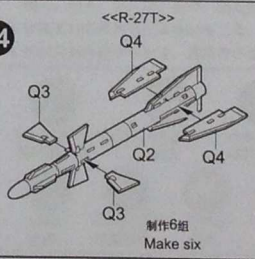

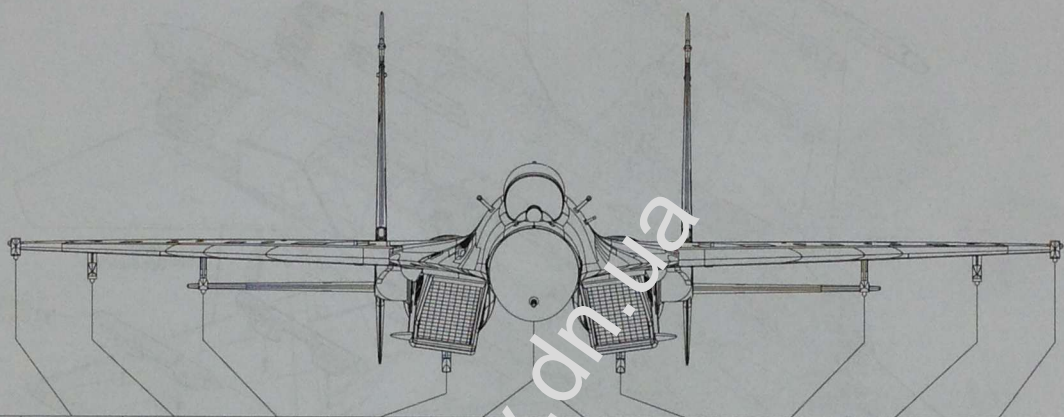

| Sta. No. | 1 | 2 | 3 | 4 | front | back | 5 | 6 | 7 | 8 |
|----------|---|---|---|---|-------|------|---|---|---|---|
| R-73E | ● | ● | | | | | | | ● | ● |
| R-27T | | | ● | ● | ● | ● | ● | ● | | |
| R-27R | | | ● | ● | ● | ● | ● | ● | | |

Stencils application scheme

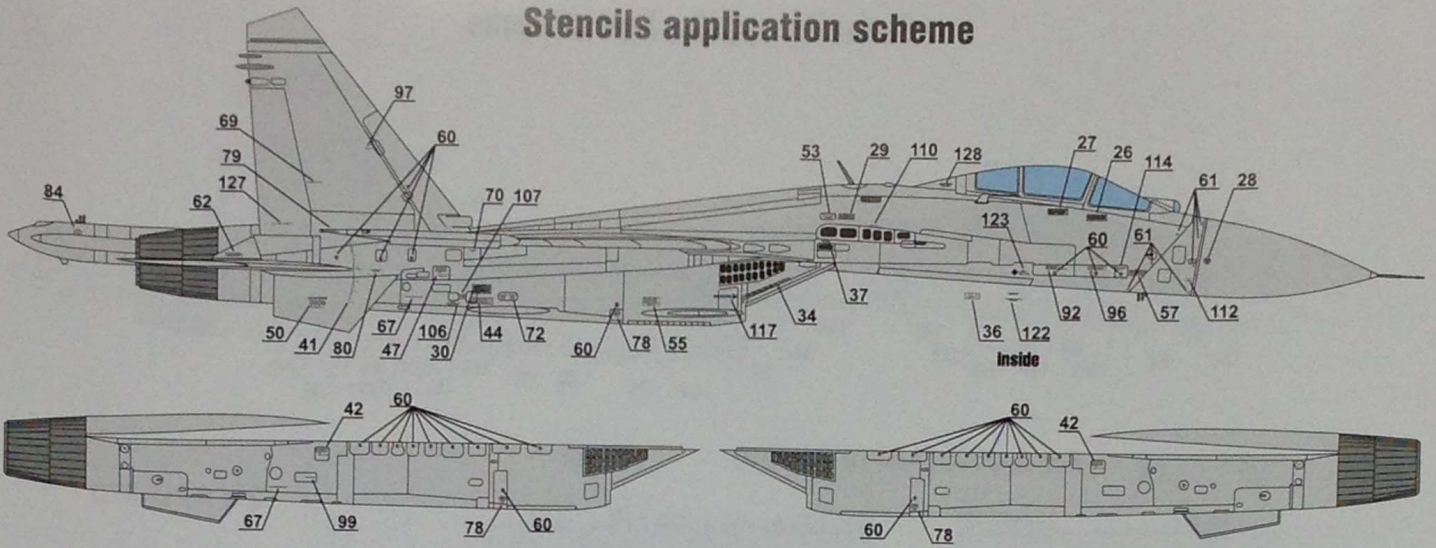

6 x R-73 (AA-11 Archer)

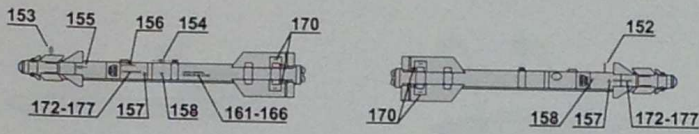

2 x APU-73

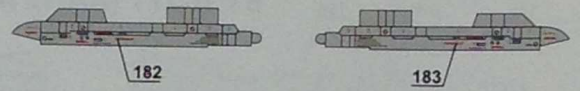

2 x AKU-470

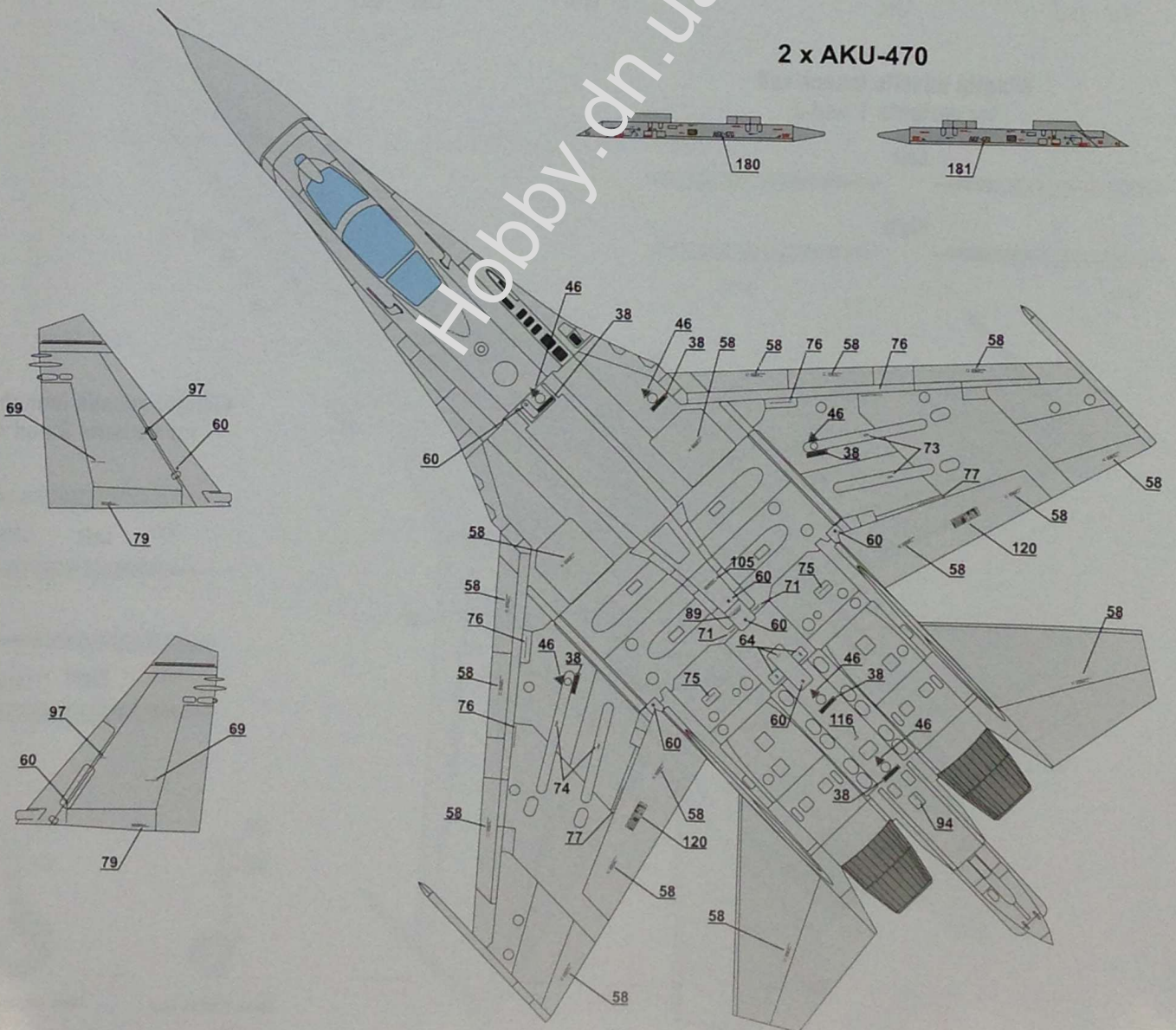

3. Su-27P blue 56", 831st Tactical Aviation Brigade, Airshow SIAD-2004, Bratislava, June 2004.

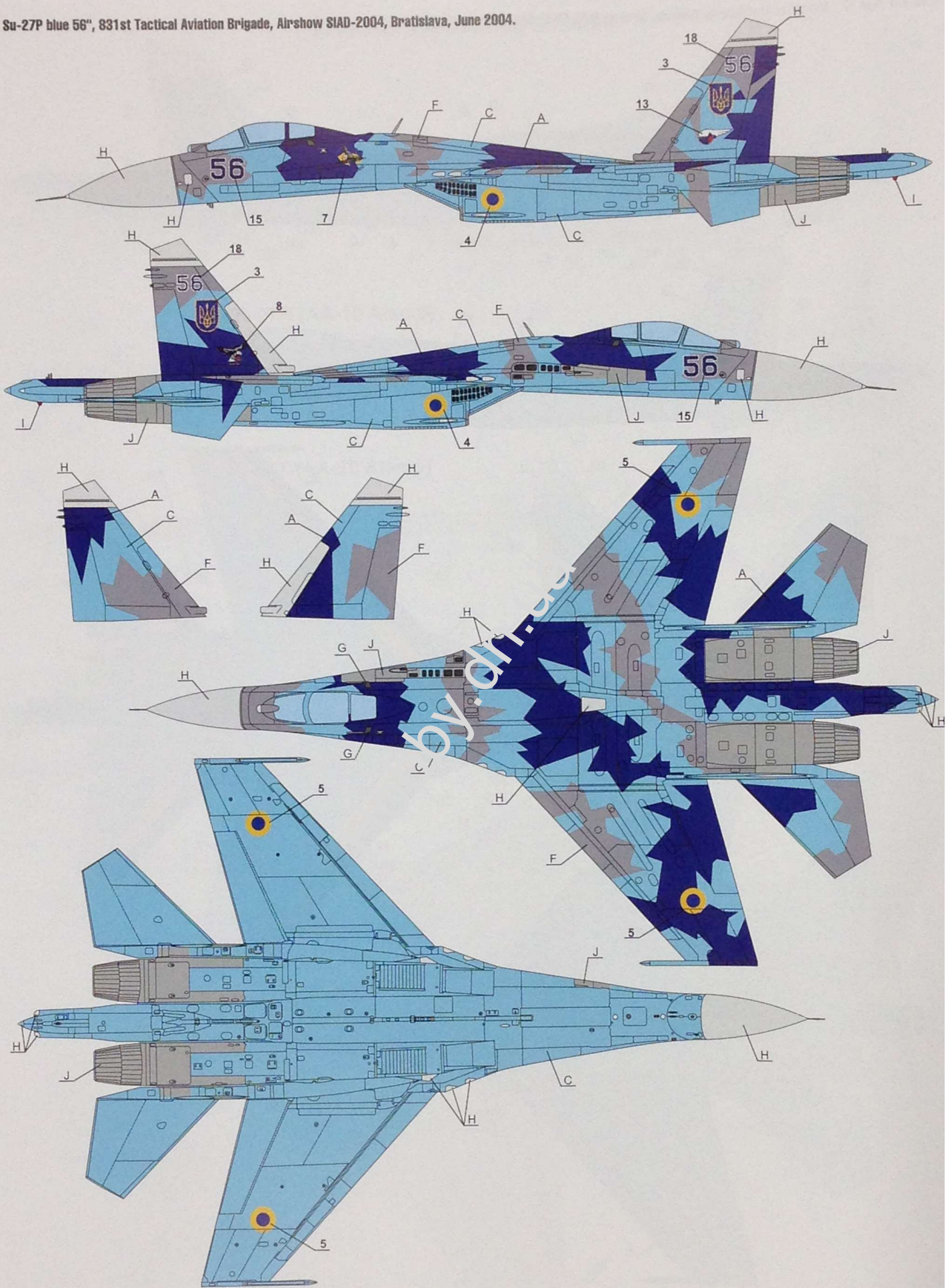

| | | | | | | |
|---|---|---|--|---|--------------------------------------|---|
| βA | βC | βF | βG | βH | βI | βJ |
| | | | | | | |
| HATAKA A220 Vallejo 70.809 Traffic Blue | HATAKA A321 Vallejo 70.841 Light Blue | HATAKA C249 Vallejo 71.047 Dusty Grey | HATAKA A041 Vallejo 71.057 Black | HATAKA A101 Vallejo 71.001 Sage White | HATAKA A276 Vallejo 71.003 Red | HATAKA C106 Vallejo 70.863 Gunmetal |

1. Su-27PM1 blue 58", 39th separate squadron of tactical aviation, Odesa, Zhytomyr region, August 2016.



| | | | | | |
|---|---|---|--|--------------------------------------|---|
| | | | | | |
| HATAKA A320 Vallejo 70.844 Sky Blue | HATAKA A321 Vallejo 70.841 Light Blue | HATAKA C335 Vallejo 71.259 Mouse Grey | HATAKA A041 Vallejo 71.057 Black | HATAKA A276 Vallejo 71.063 Red | HATAKA C166 Vallejo 70.863 Gunmetal |

2. Su-27P blue 39ⁿ, 39th separate squadron of tactical aviation, Ozerne, Zhytomyr region, July 2011.

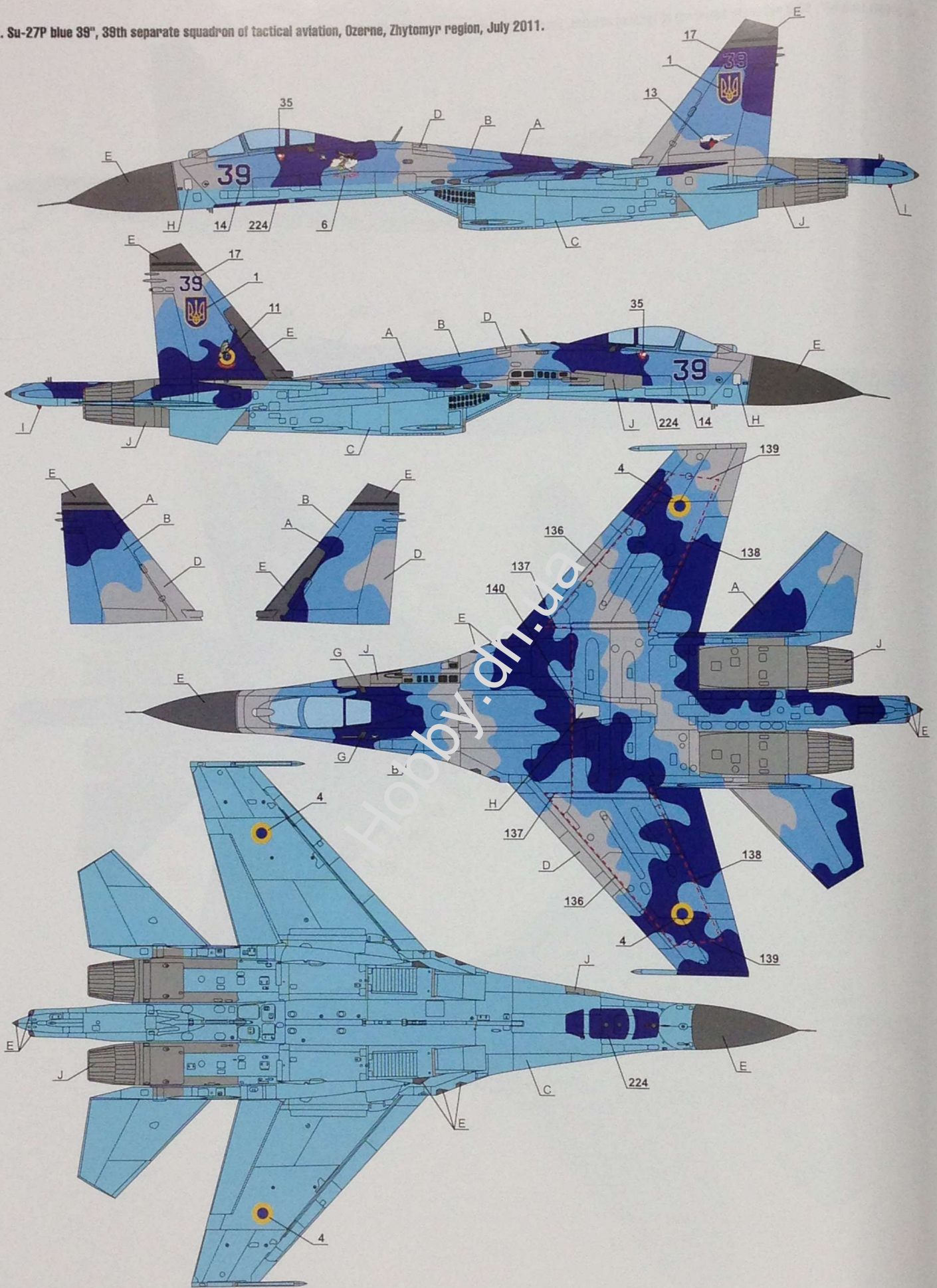

- | | | | | | | | | |
|---|---|---|--|---|--|--|--|---|
| | | | | | | | | |
| A HATAKA A220 Vallejo 70.809 Traffic Blue | B HATAKA A320 Vallejo 70.844 Sky Blue | C HATAKA A321 Vallejo 70.841 Light Blue | D HATAKA C334 Vallejo 71.050 Window Grey | E HATAKA C335 Vallejo 71.259 Mouse Grey | G HATAKA A041 Vallejo 71.057 Black | H HATAKA A101 Vallejo 71.001 Satin White | I HATAKA A276 Vallejo 71.003 Red | J HATAKA C106 Vallejo 70.863 Gunmetal |

4. Su-27P blue 57", 831st Tactical Aviation Brigade, Airshow SIAO-2002, Bratislava, June 2002.

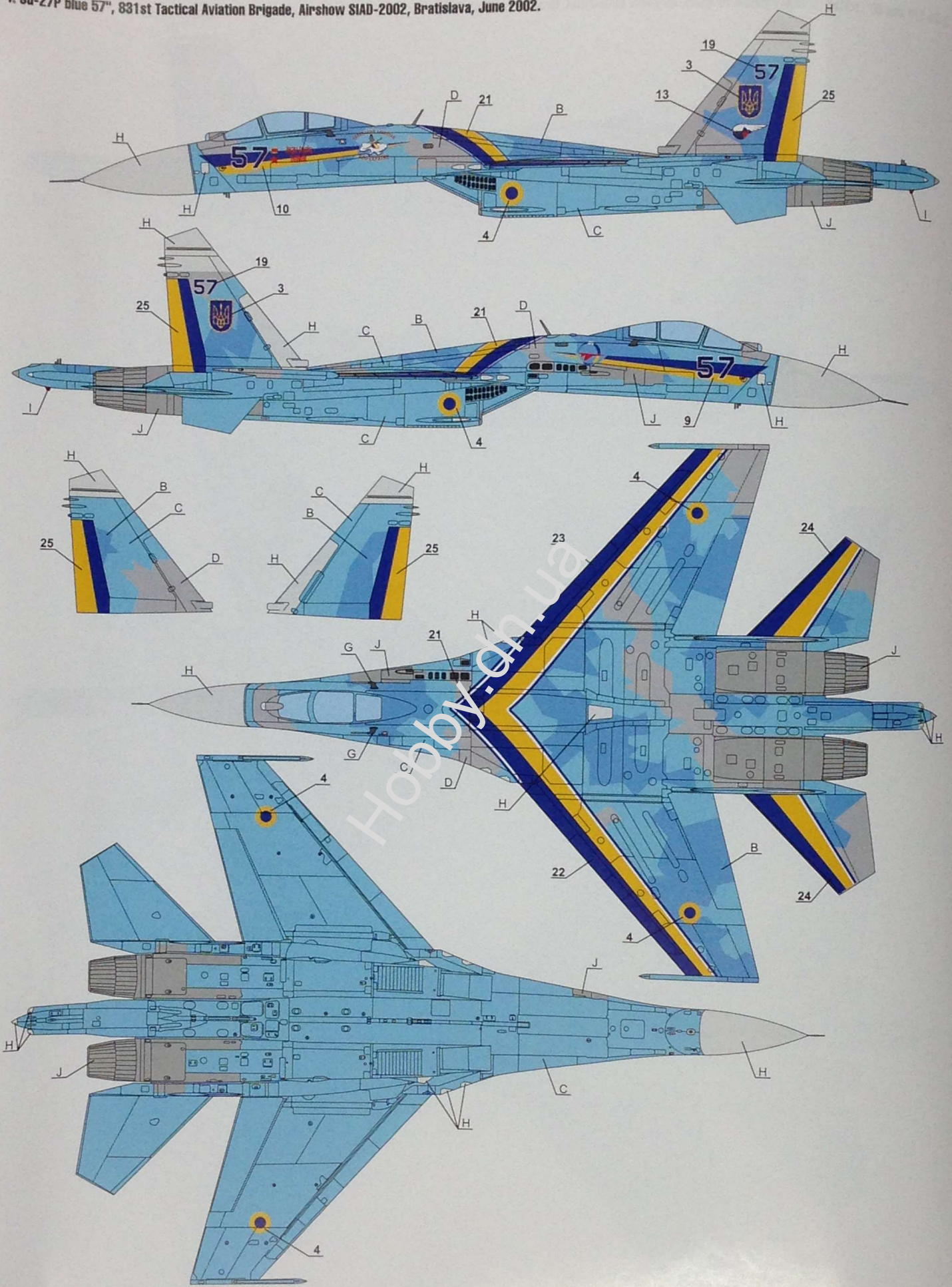

- | | | | | | | |
|---|---|--|---------------------------------------|---|--------------------------------------|---|
| B | C | D | G | H | I | J |
| | | | | | | |
| HATAKA A320 Vallejo 70.845 Sky Blue | HATAKA A321 Vallejo 70.851 Light Blue | HATAKA C334 Vallejo 71.050 Window Grey | HATAKA AG41 Vallejo 71.057 Dark | HATAKA J 191 Vallejo 71.061 Satin White | HATAKA A276 Vallejo 71.003 Red | HATAKA C106 Vallejo 70.863 Gunmetal |

Stencils application scheme

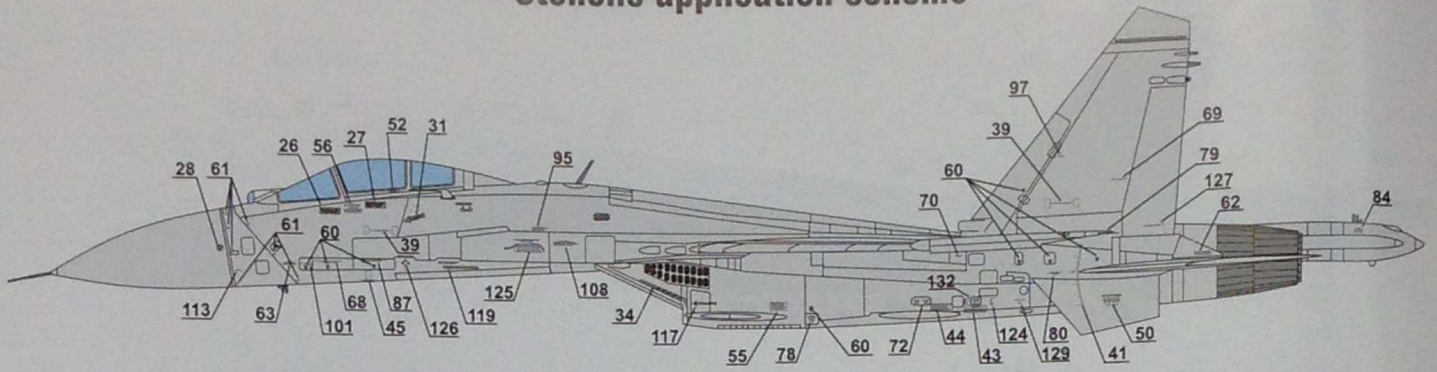

6 x R-27R (AA-10 Alamo)

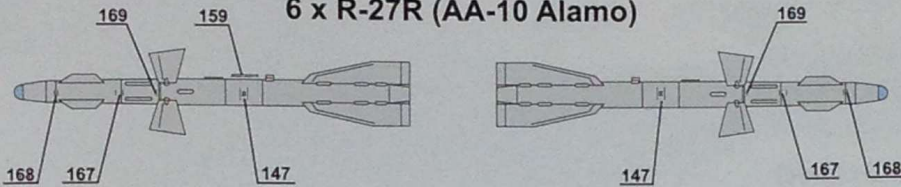

2 x APU-470

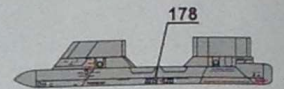

6 x R-27T (AA-10 Alamo)

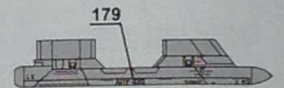
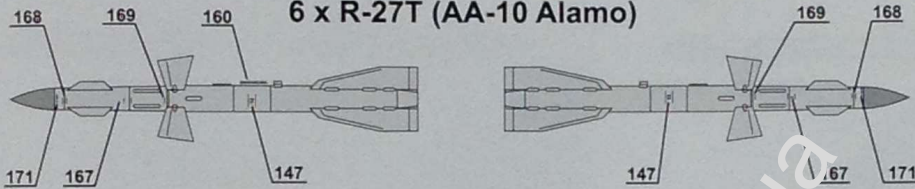

Wingtip missile launch rail for variants 1 and 2

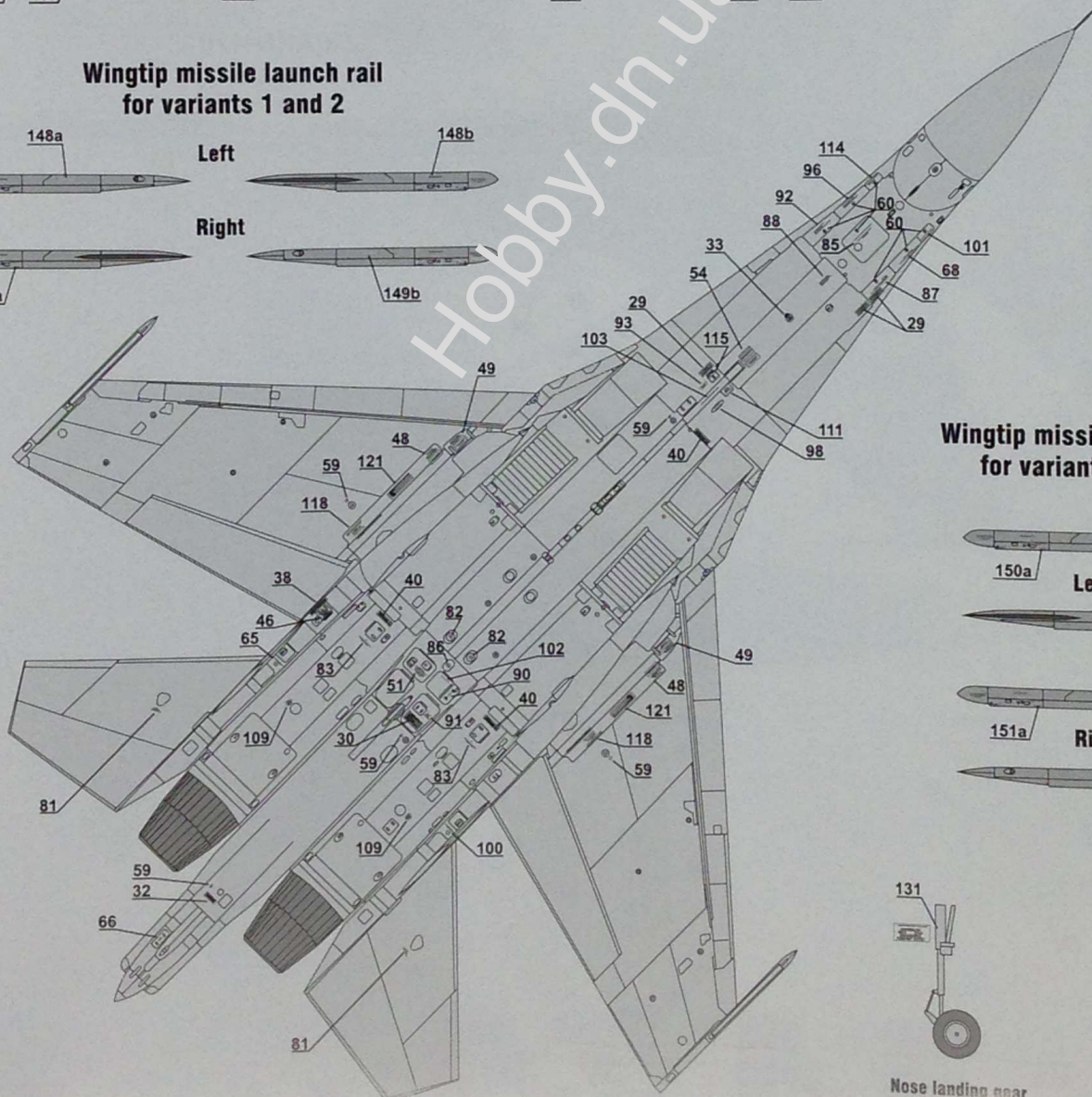
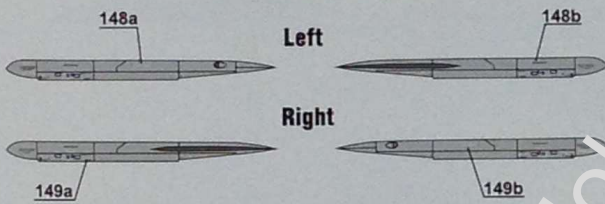

Wingtip missile launch rail for variants 3 and 4

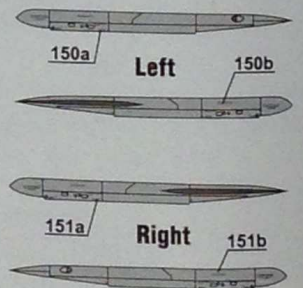

Nose landing gear



Main landing gear