

# Roland D II

## Pfalz D II

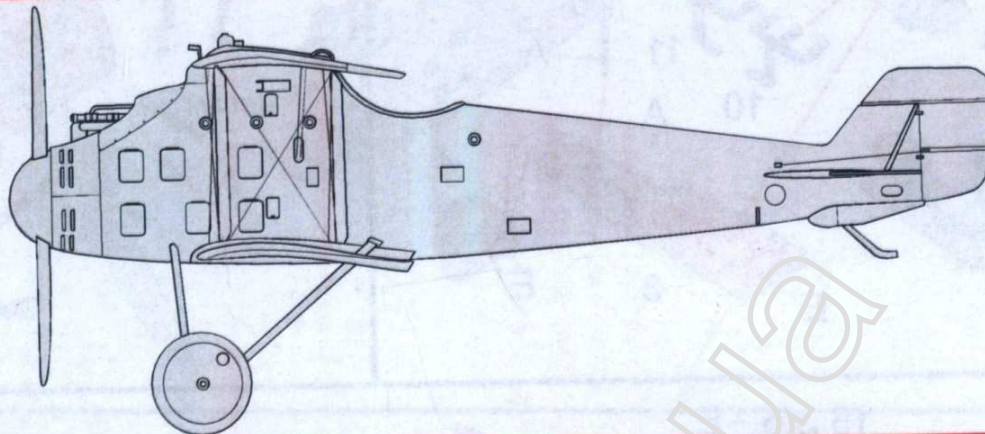

Historie / History  
[https://en.wikipedia.org/wiki/LFG\\_Roland\\_D.II](https://en.wikipedia.org/wiki/LFG_Roland_D.II)

Plastikové díly - Plastic parts

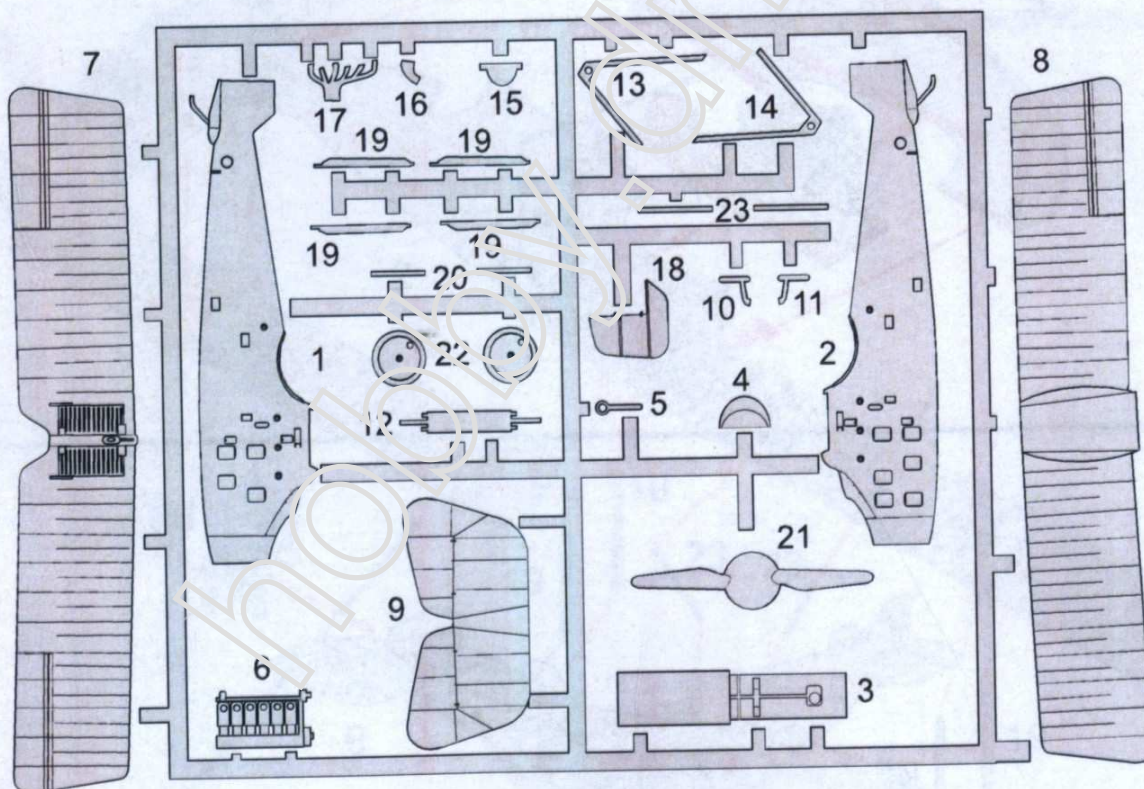

Používejte pouze vhodné nářadí, lepidlo a barvy. Během práce nejezte a nepijte.  
POZOR - obsahuje malé součásti, které mohou mít ostré hrany. Není vhodné pro děti.

Use proper tools, glue and paints. Do not eat and drink during the work.  
WARNING - contains small parts with possible sharp edges. Not suitable for children.

  
VOLITELNÉ  
OPTIONAL

  
VYVRTAT  
DRILL HOLE

  
ZBROUSIT  
REDUCE

  
ODSTRANIT  
REMOVE

Colour name	Humbrol	Colour name	Humbrol
A Black	H33	G Aluminium	H56
B White	H34	H Silver	H11
C Light Blue	H106	I Linen	H74
D Light Grey	H64	J Red	H132
E Wood	H110	K Tyre	H85
F Yellow	H24	L Rust	H113

Stavební postup - Assembly instructions

1

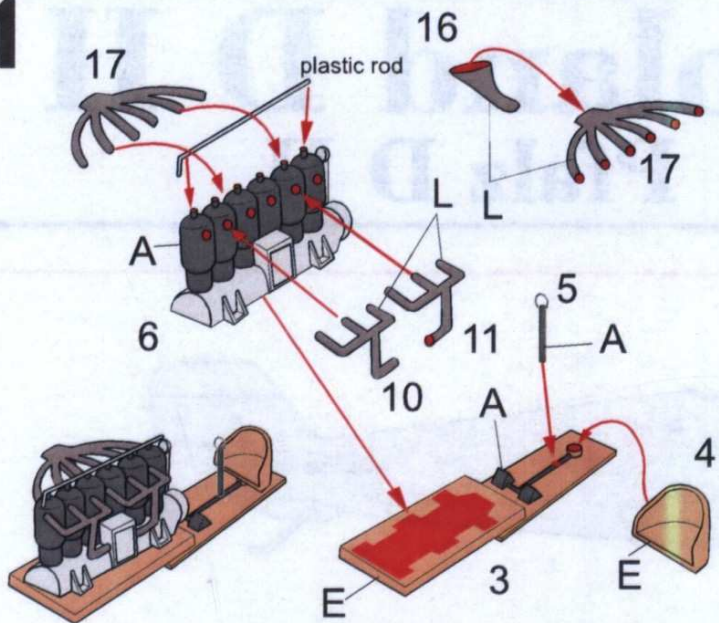

2

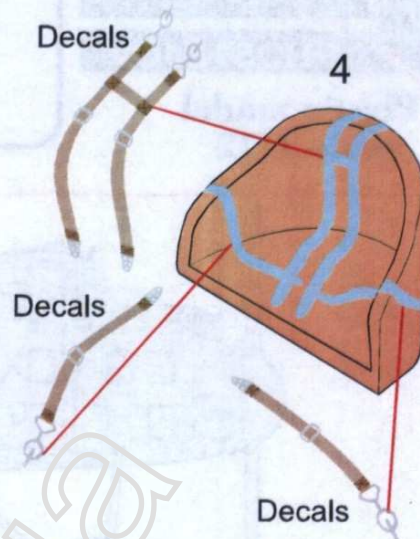

3

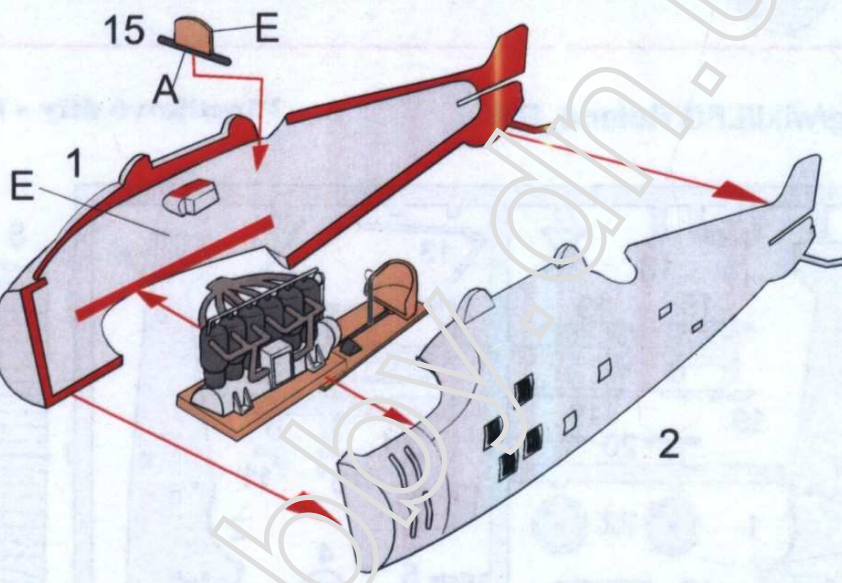

4

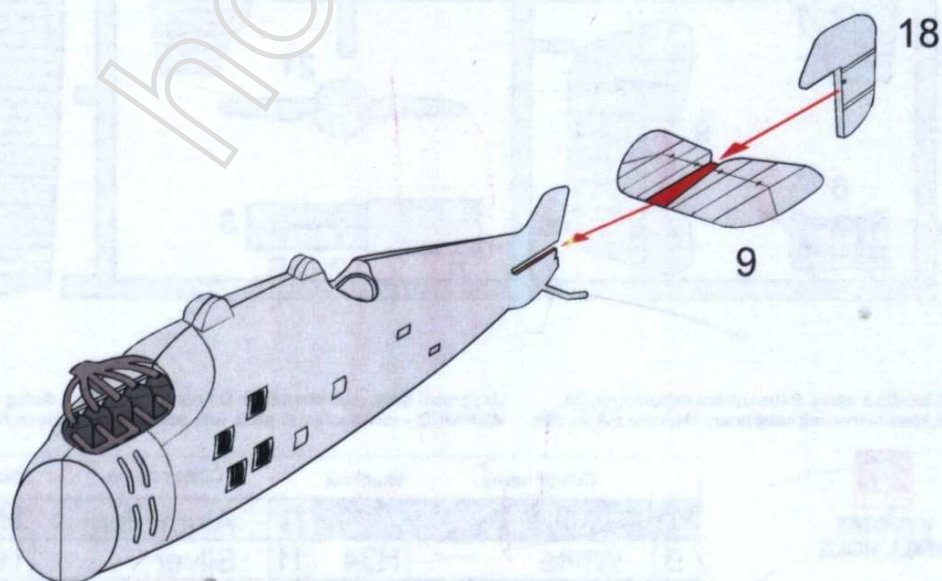

5

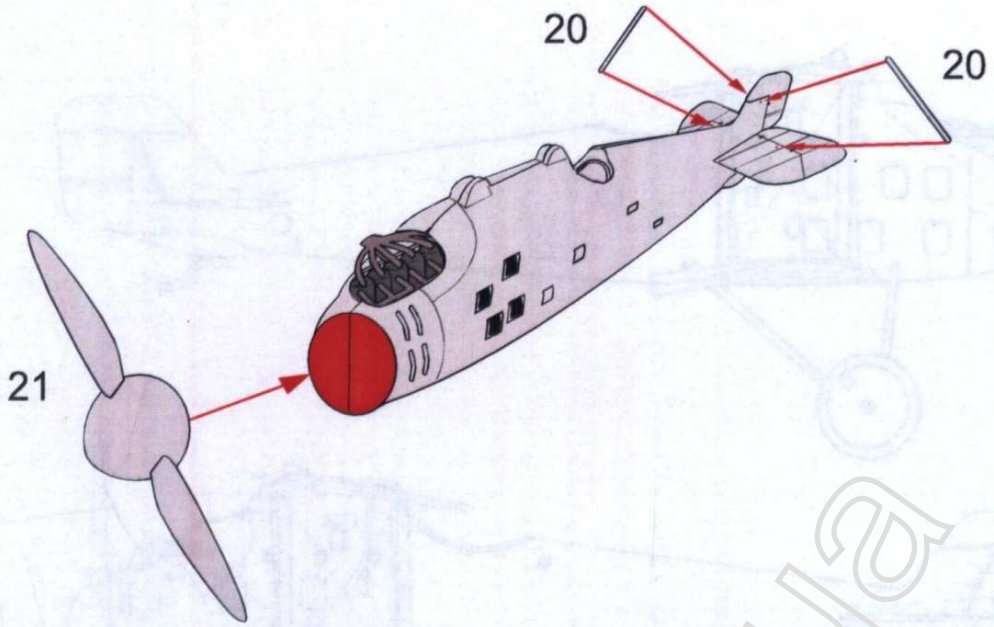

6

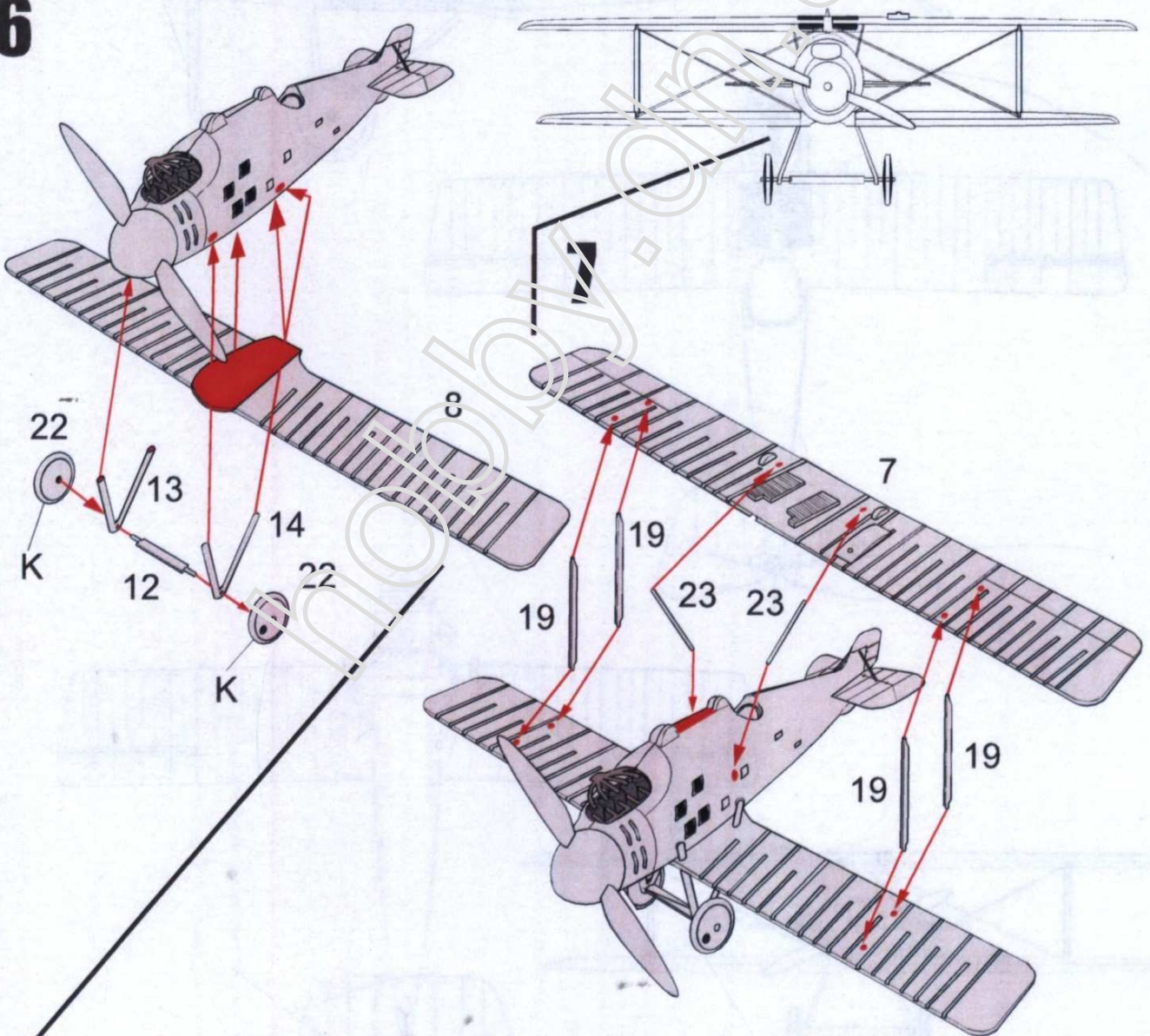

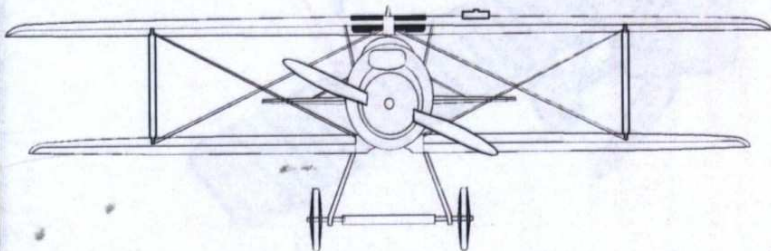
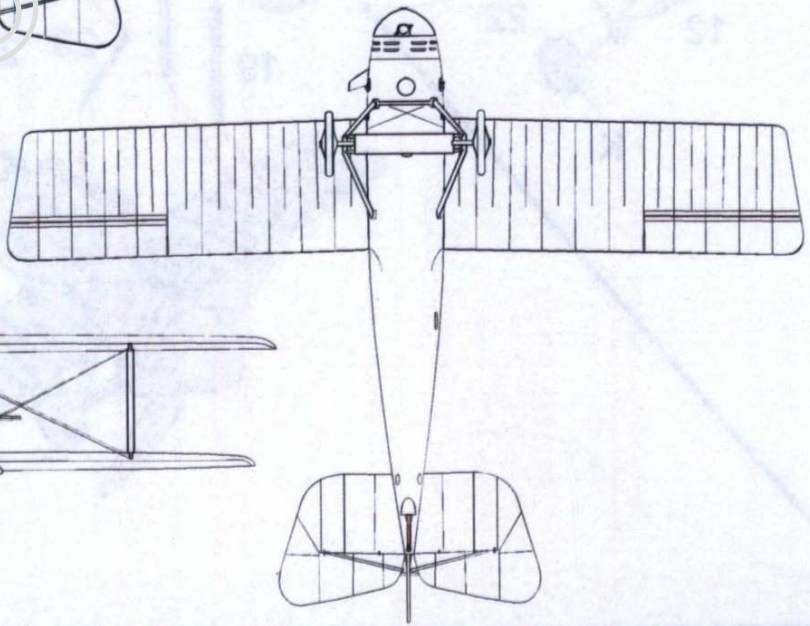
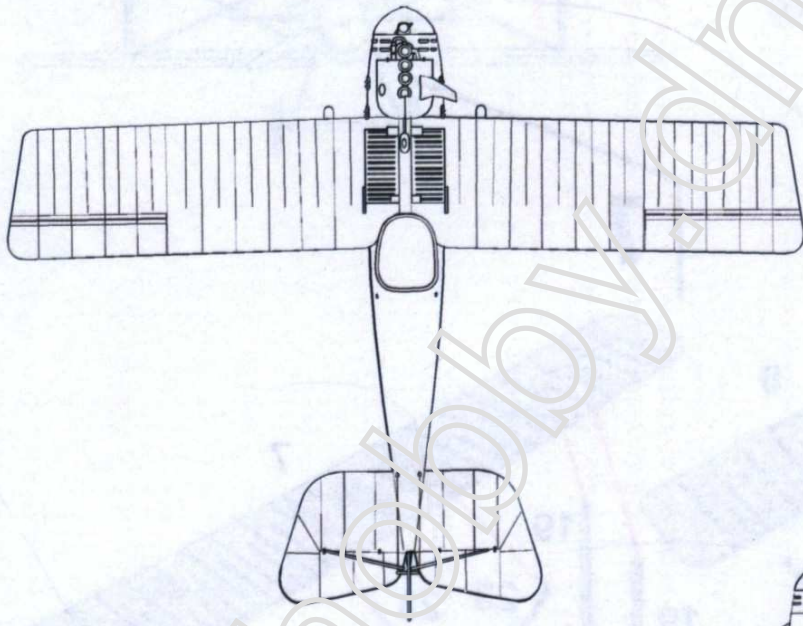
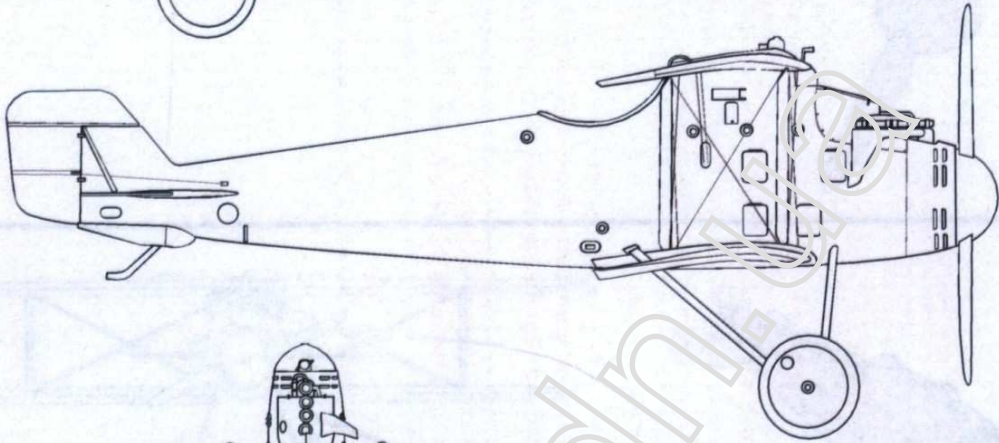
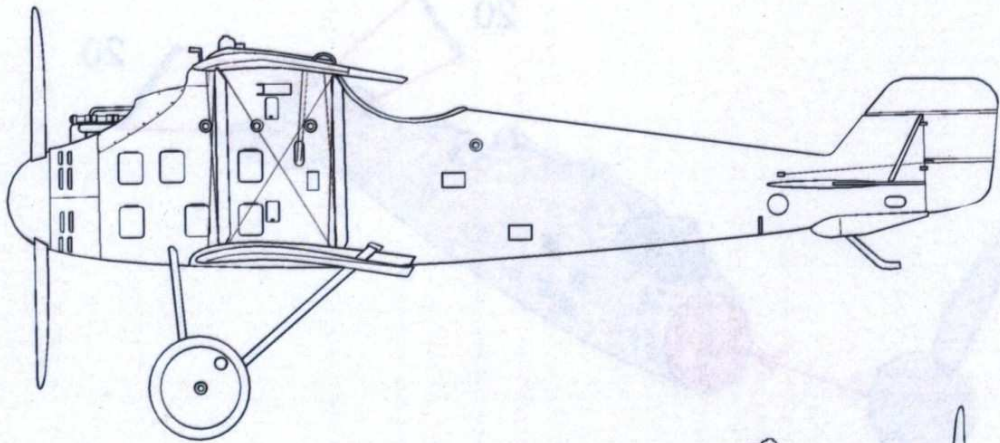

**Zbarvení & Označení  
Colours & Markings**

**1**

**LFG Roland D II, Jasta 25, západní fronta, 1917.**  
*LFG Roland D II, Jasta 25, Western Front, 1917.*

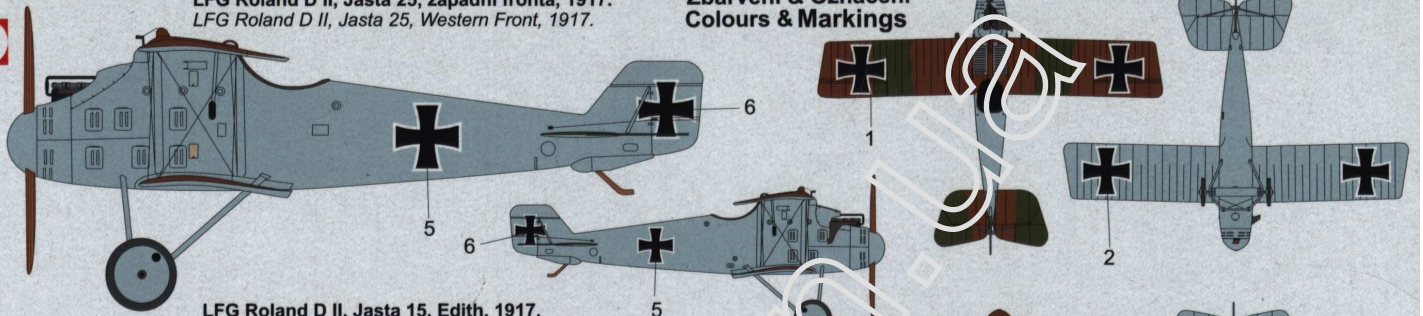

**2**

**LFG Roland D II, Jasta 15, Edith, 1917.**  
*LFG Roland D II, Jasta 15, Edith, 1917.*



**3**

**LFG Roland D II, se znakem města Halle, Německo, 1917.**  
*LFG Roland D II, With the coat of arms of the city Halle, Germany, 1917.*

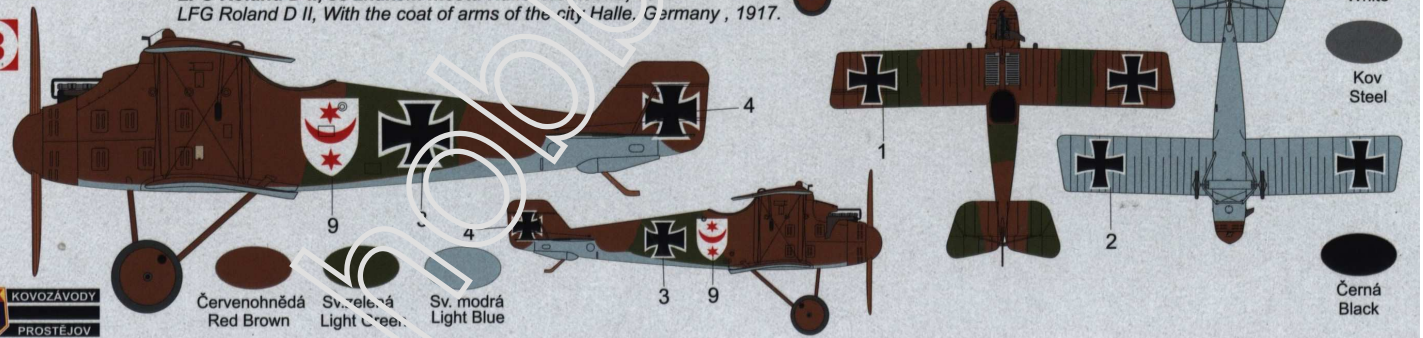

Červenohnědá  
Red Brown

Sv. zelená  
Light Green

Sv. modrá  
Light Blue

○  
Bílá  
White

●  
Kov  
Steel

●  
Černá  
Black