

BOEING™

C-17 GLOBEMASTER III™

波音™ C-17 “环球霸王III™” 运输机 **TRANSPORTER**



C-17 Globemaster III™
Produced under license. Boeing and
C-17 Globemaster III are trademarks
of The Boeing Company.



Hobby.dn.ua



mPLANE-007

MENG
WWW.MENG-MODEL.COM

注意事项 IMPORTANT NOTES

⚠ A 注意:

- Ⓜ 请勿吞食产品包装中的物品，包括但不限于零件、水贴、不干胶贴纸、包装袋等。
- Ⓜ 将板件取出后应立即丢弃包装袋，请勿将包装袋置于口鼻处或套在头上，以免引起窒息。
- Ⓜ 请勿将本产品置于明火或者高温源附近。
- Ⓜ 本产品内零件可能包含尖角，请注意避免伤害。

⚠ A Caution:

- Ⓜ Don't swallow any items in the package, including but not limited to parts, stickers, decals and plastic bags.
- Ⓜ Please dispose properly the plastic bags after taking sprues out. To avoid danger of suffocation, keep the plastic bags away from your mouth, nose or head.
- Ⓜ Keep this product away from fire or high temperature sources.
- Ⓜ This product may contain parts which have sharp points. Please be careful not to get injured.

⚠ B 制作前必读

- Ⓜ 组装前请仔细阅读手册，并按照手册标明的步骤进行制作。
- Ⓜ 确定零件编号后再将其从板件上取下，请勿一次取下多个零件，以免丢失或混淆。
- Ⓜ 如需涂装，请在通风环境下进行，并按照涂料的注意事项操作。

⚠ B Read carefully before assembly

- Ⓜ Please read carefully and fully understand the manual before starting assembly.
- Ⓜ Check part numbers before removing parts from sprues. To avoid missing or mixing up some parts with other items, don't remove many parts at a time.
- Ⓜ If you need to paint this model, please paint in a ventilated environment, and follow the painting notices.

Ⓜ 使用工具

Ⓜ Tools recommended

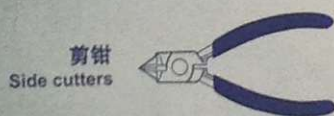

笔刀
Hobby knife



镊子
Tweezers



水贴使用说明

Decal application

- ① 将水贴从薄片上剪下。
- ② 将水贴在温水浸泡10秒钟，然后将其放在干净的布上。
- ③ 夹住底纸的边缘，将水贴滑动到模型上。
- ④ 用蘸水的手指将湿润的水贴移动到合适的位置。
- ⑤ 用软布轻轻按压水贴，直到将多余的水和气泡压出为止。

- ① Cut off decal from sheet.
- ② Dip the decal in tepid water for about 10 sec and place on a clean cloth.
- ③ Hold the backing sheet edge and slide decal onto the model.
- ④ Move decal into position with a wet finger.
- ⑤ Press decal gently down with a soft cloth until excess water and air bubbles are gone.

零件图 PARTS

A PARTS

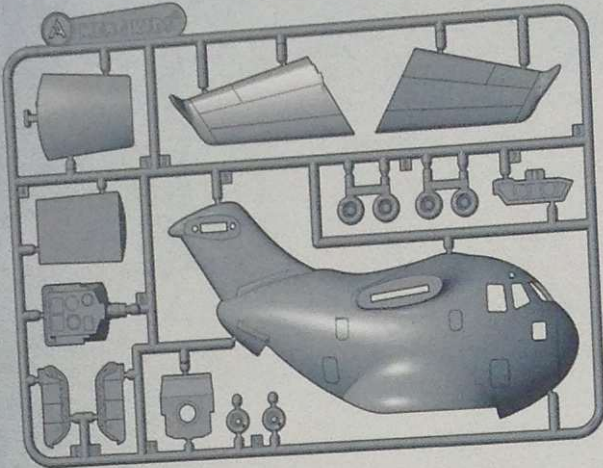

C PARTS

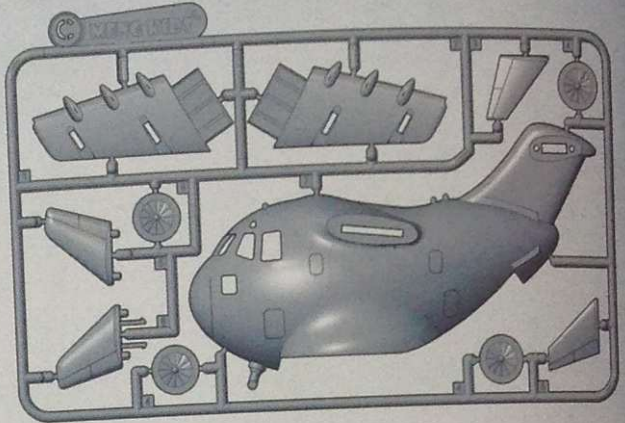

B PARTS

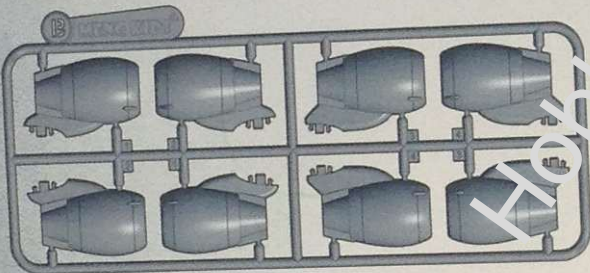

D PARTS

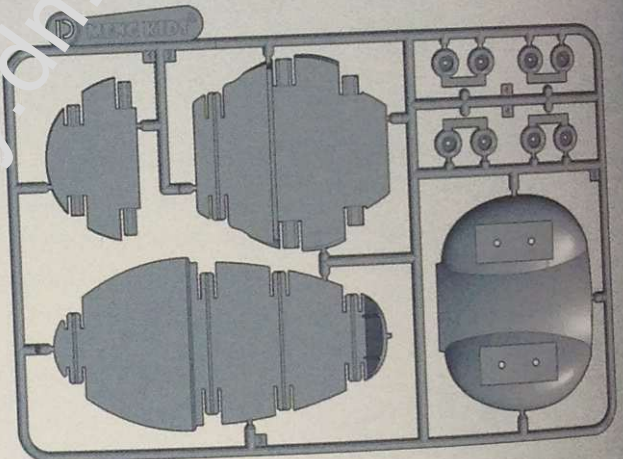

水贴
Decal



贴纸
sticker



E PARTS

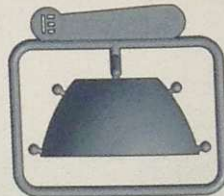



机身组装1 FUSELAGE ASSEMBLY 1

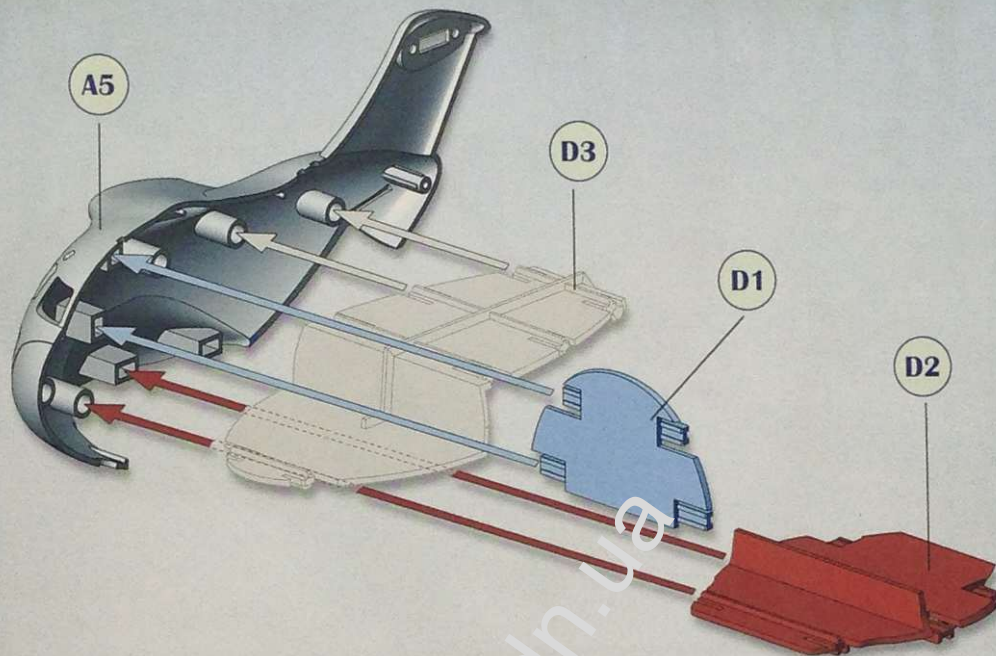

机身组装2 FUSELAGE ASSEMBLY 2

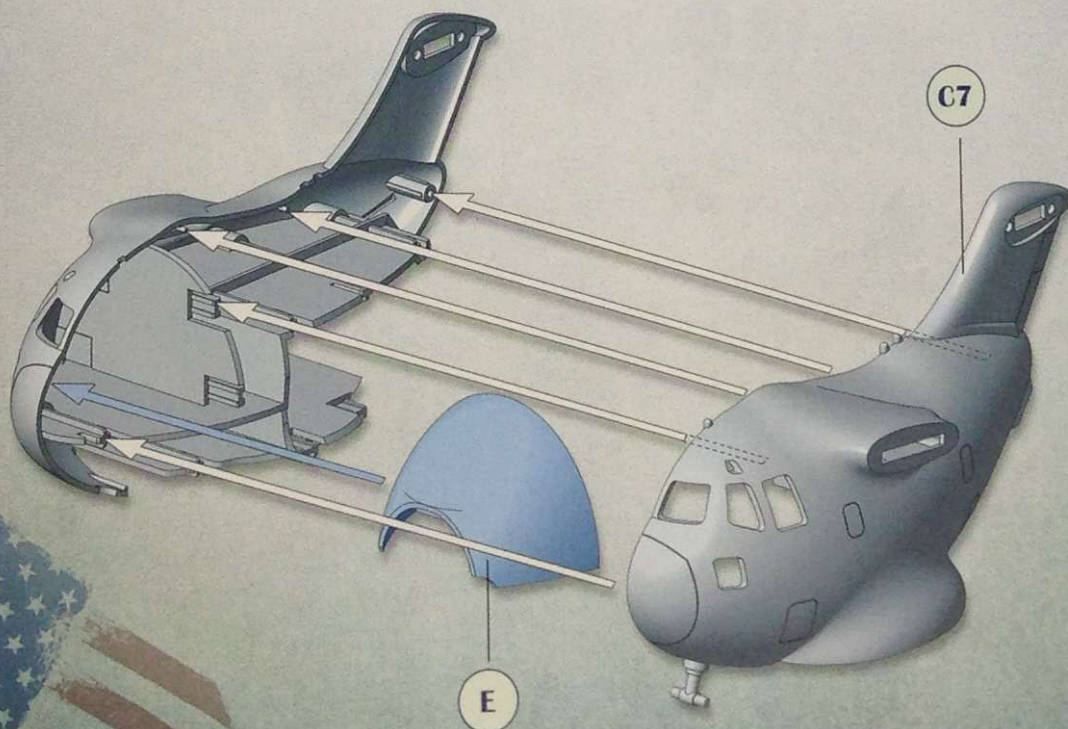

3

机身组装3 FUSELAGE ASSEMBLY 3

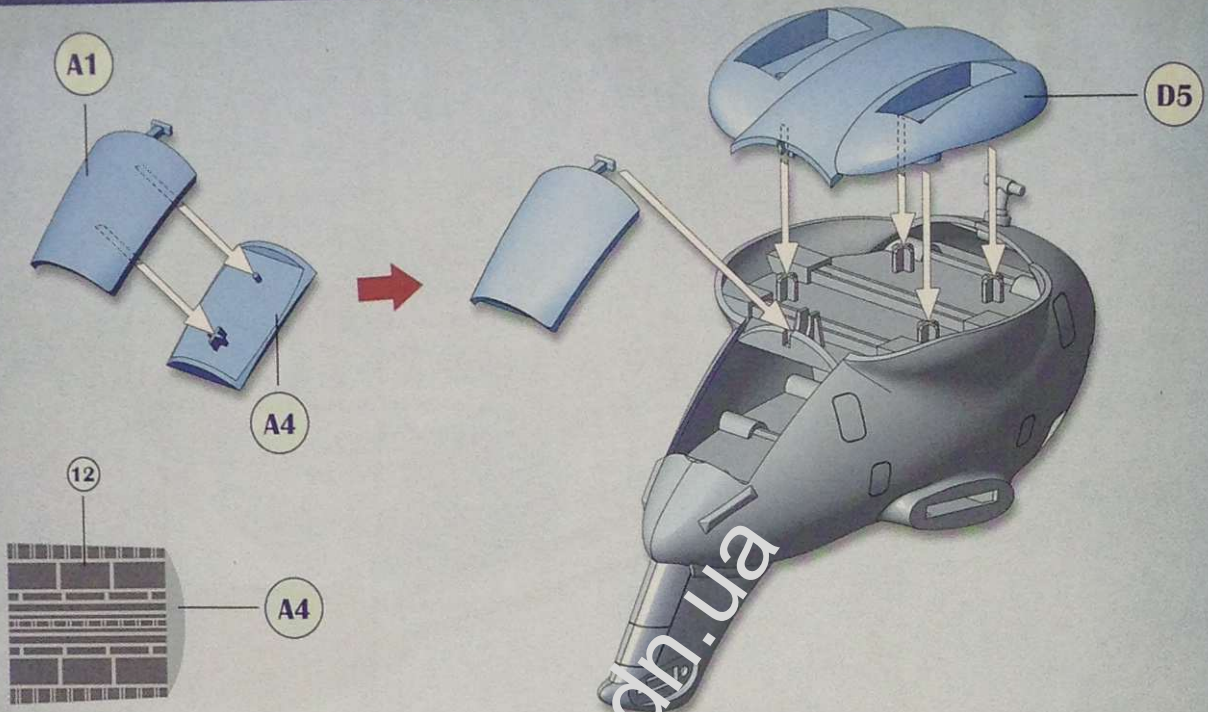

4

轮组组装 WHEELS ASSEMBLY

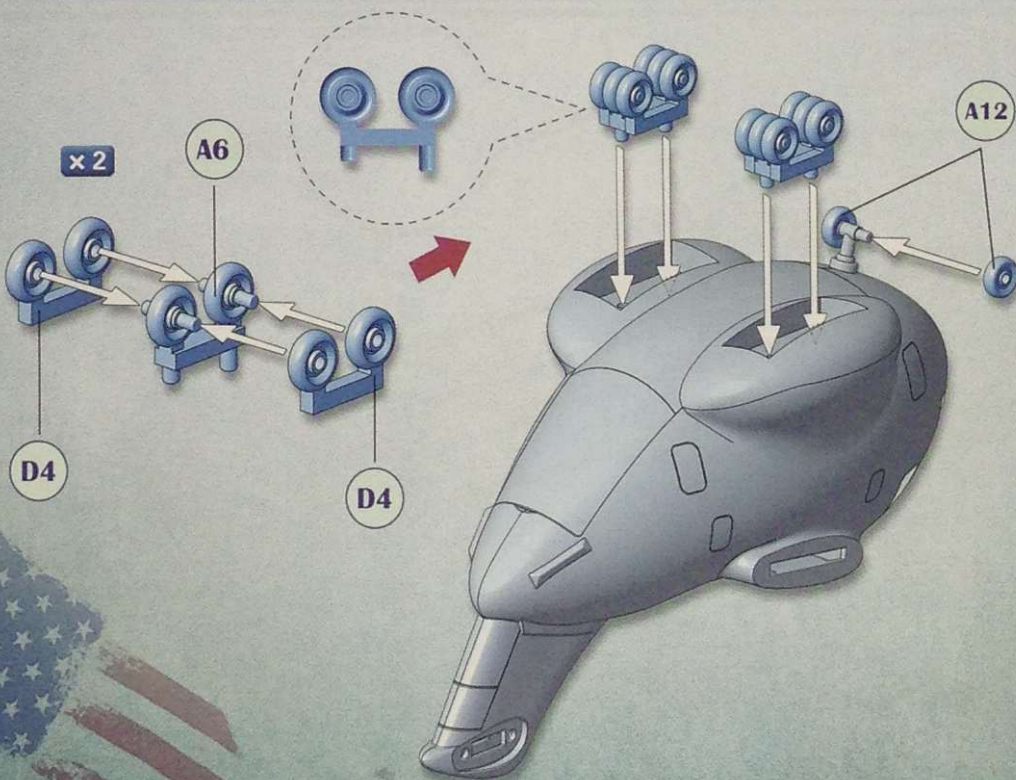

5

机翼组装 WING ASSEMBLY



⚠ 1 2 3

☑ 依照数字顺序组合
☑ Attaching in numerical order.

6

发动机组装 ENGINE ASSEMBLY

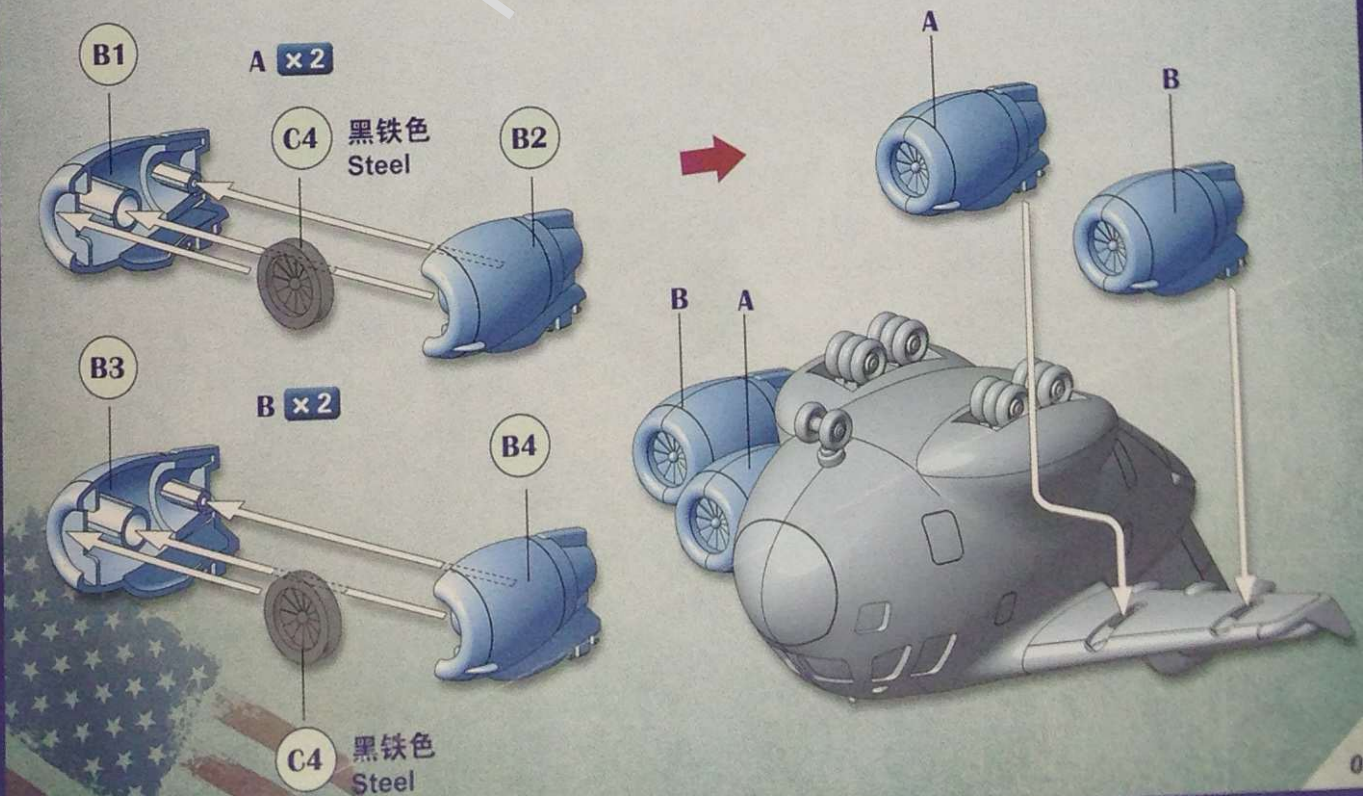

M1坦克组装 M1 TANK ASSEMBLY

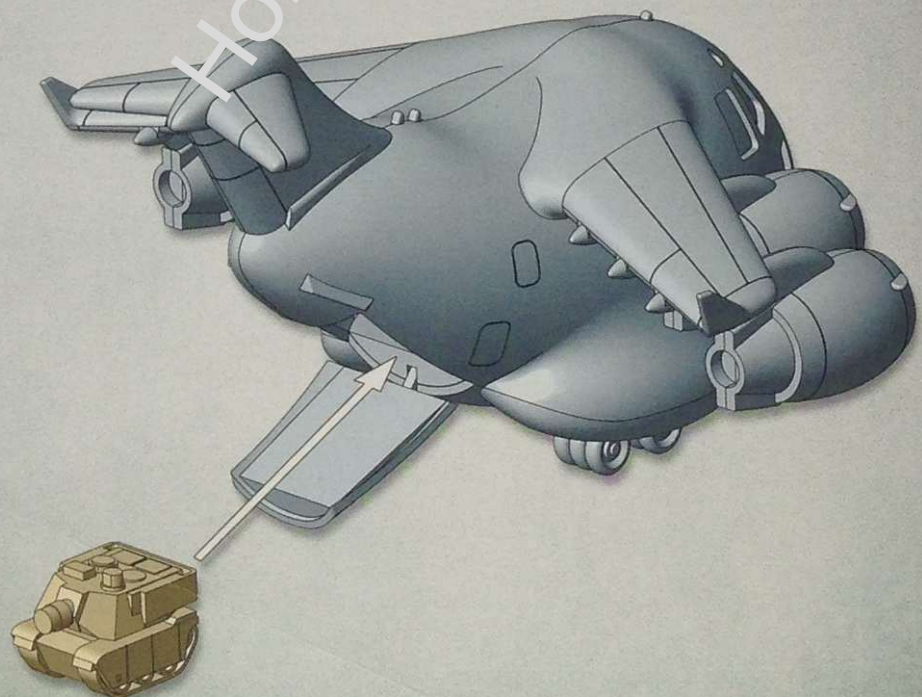
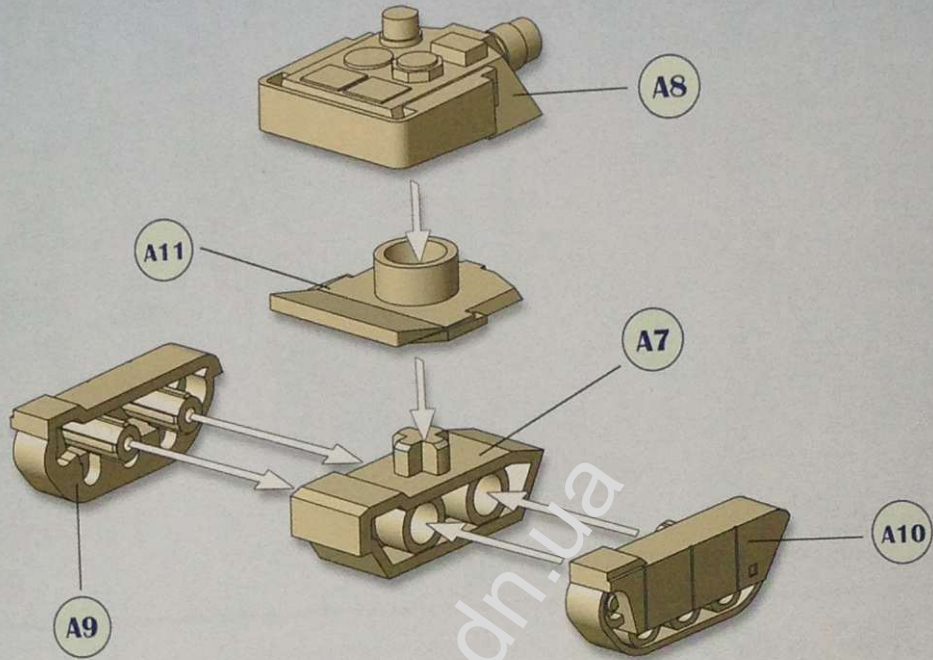



涂装指示 PAINTING

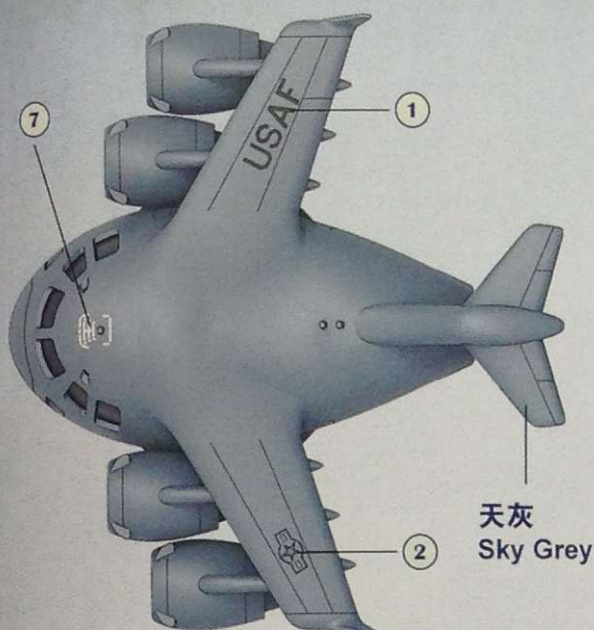

天灰
Sky Grey

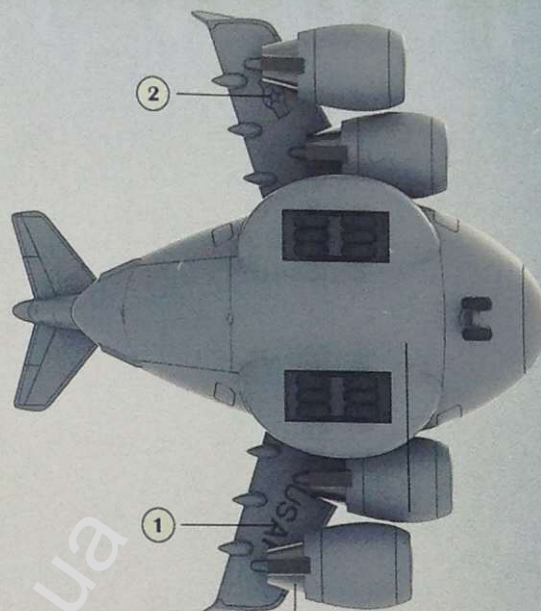

黑铁色
Steel

美军现代沙漠黄
U.S. Desert Tan

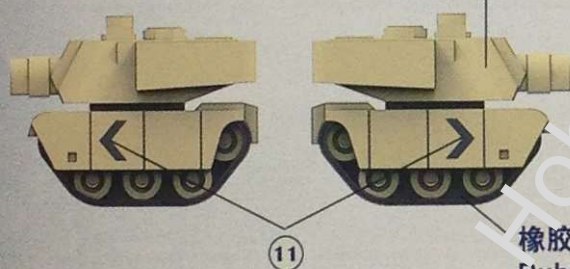

橡胶黑
Rubber Black

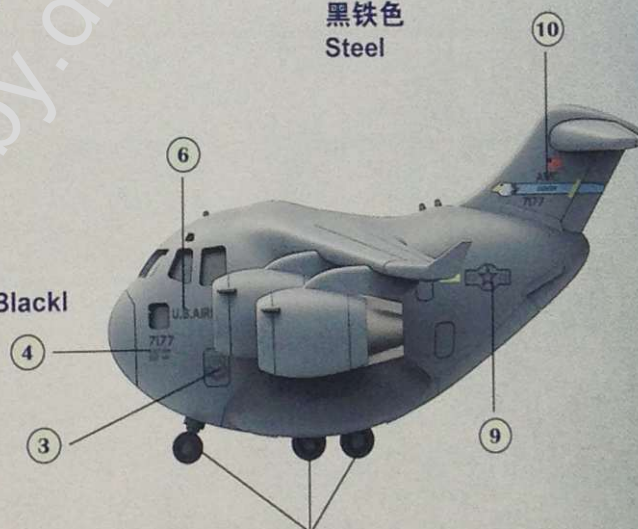

橡胶黑
Rubber Black

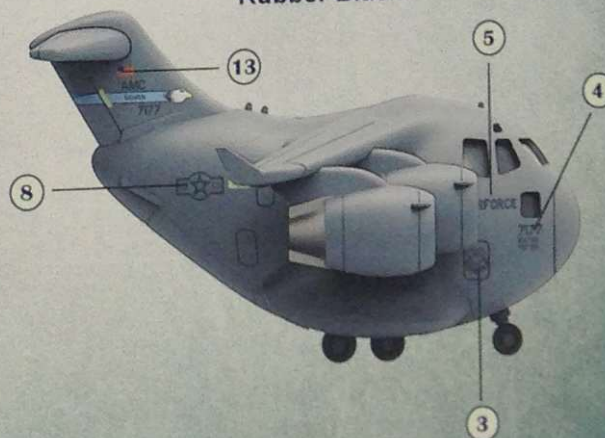

1. 可参照图示的色彩使用涂料进行涂装，以获得更精美的视觉效果。
2. 涂装时需要使用塑料模型专用喷涂工具、毛笔或塑料模型专用马克笔。
3. 在涂装时请遵从涂料及涂装工具的使用说明。
4. 本产品不含涂料及涂装工具。

1. You can paint the model with the suggested colors to achieve better visual effect.
2. You need paint spraying tools, paint brushes or special markers for plastic models.
3. Please follow the instructions of paints and painting tools when you paint the model.
4. Paints and painting tools are not included in this product.



颜色对照表

COLOR REFERENCE



天灰	Sky Grey	MC-021	N57
美军现代沙漠黄	U.S. Desert Tan	MC-201	N66
橡胶黑	Rubber Black	MC-202	N77
黑铁色	Steel	MC-508	N28

★ 推荐使用MENG模型专用水性环保颜料或君仕新水性涂料为本产品进行涂装。
We recommend to use MENG Color series water based acrylic colors or M. Hobby AcrySION water based colors to paint the model.



售后

AFTER-SALES SERVICE

如果零件有缺失、破损等不良情况或者您对产品有任何建议，请用以下方式联系我们：

咨询热线：4001-870-090

邮箱：after-sales@meng-model.com

网址：www.meng-model.com

地址：广东省深圳市福田区彩田路3069号星河世纪大厦A栋3016

邮编：518000

If there are parts missing or broken, or if you have any suggestions, please contact us:

Hotline: +86 4001-870-090

E-mail: after-sales@meng-model.com

Website: www.meng-model.com

Address: Rm. 3016, Blk. A, Galaxy Century Bldg., No. 3069 Caitian Rd., Futian Dist.,
Shenzhen, Guangdong, China

Zip code: 518000





MENG
WWW.MENG-MODEL.COM

Hobby-arena