



06784-0379

LEVEL 3
1 2 3 4 5

DIN DJARIN™ - THE BOUNTY HUNTER

Beiliegenden Sicherheitstext beachten / Please note the enclosed safety advice

- Ⓢ Beiliegenden Sicherheitstext beachten und nachschlagbereit halten.
- Ⓢ Please note the enclosed safety advice and keep safe for later reference.
- Ⓢ Respecter les consignes de sécurité ci-jointes et les conserver à portée de main.
- Ⓢ Houdt u aan de bijgaande veiligheidsinstructies en hou deze steeds bij de hand.
- Ⓢ Seguire le avvertenze di sicurezza allegate e tenerle a portata di mano.
- Ⓢ Observar y siempre tener a disposición este texto de seguridad adjunto.
- Ⓢ Ter em atenção o texto de segurança anexo e guardá-lo para consulta.

- Ⓢ Overhold vedlagte sikkerhedsanvisninger og hav dem liggende i nærheden.
- Ⓢ Ha alltid vedlagt sikkerhetstekst klar til bruk.
- Ⓢ Beakta bifogad säkerhetstext och håll den i beredskap.
- Ⓢ Huomioi ja säilytä oheiset varoitukset.
- Ⓢ Соблюдать технику безопасности, сохранить инструкцию для дальнейших обращений.
- Ⓢ Przestrzegaj załączonego tekstu dotyczącego bezpieczeństwa i miej go zawsze pod ręką.
- Ⓢ Dodržujte tento příložený bezpečnostní text a mějte ho po ruce.
- Ⓢ A mellékelt biztonsági szöveget vegye figyelembe és tartsa fellepozásra készen.

- Ⓢ Respektujte priložený bezpečnostný text a uchovajte ho pre budúce použitie.
- Ⓢ Respectați textul de siguranță atașat și păstrați-l la îndemână.
- Ⓢ Спазвайте приложения текст за безопасност и го дръжете под ръка за справки.
- Ⓢ Prilofena varnostna navodila izvajajte in jih hranite na vsem dostopnem mestu.
- Ⓢ Λάβετε υπόψη σας το συνημμένο κείμενο ασφαλείας και φυλάξτε το ώστε να ανατρέχετε σε αυτό όποτε χρειάζεται.
- Ⓢ Ekteki güvenliik talimatlarını dikkate alıp, bakabileceğiniz bir şekilde muafaza ediniz.

© 2022 Revell GmbH, Henschelstr. 20-30, D-32257 Bünde.

REVELL IS THE REGISTERED TRADEMARK OF REVELL GMBH, GERMANY. www.revell.de

© & ™ Lucasfilm Ltd.
www.starwars.com

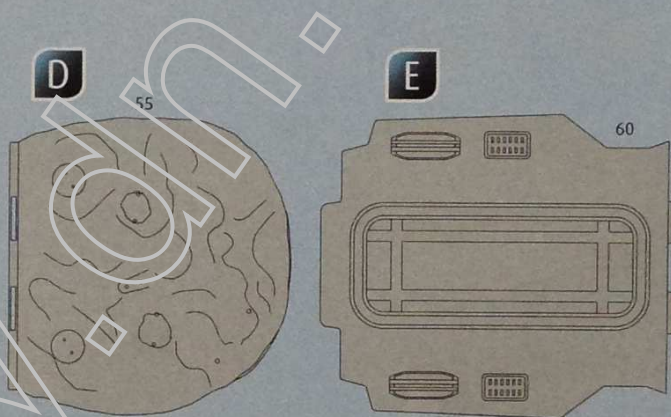
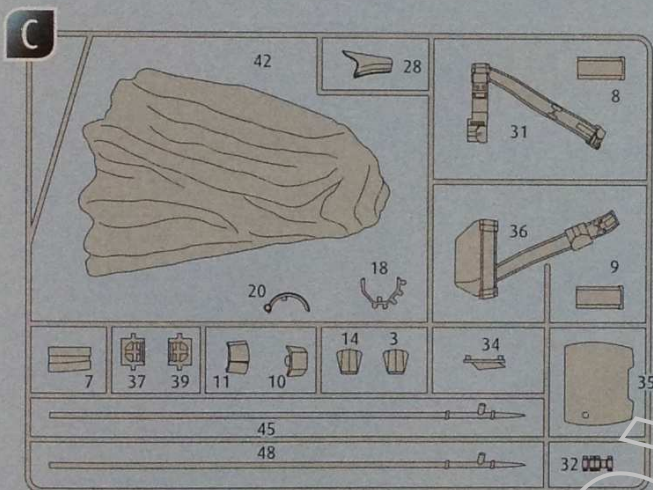
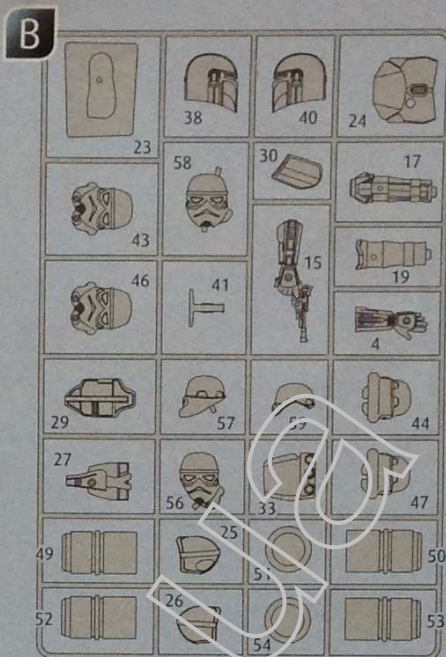
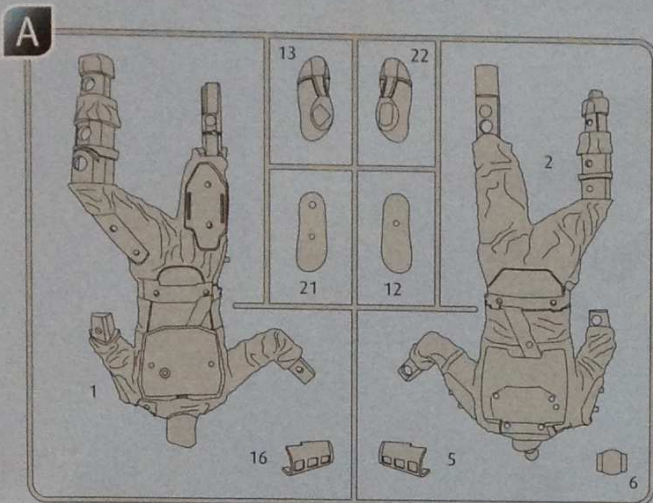

DE Kundenservice: www.revell-service.de oder **Revell GmbH, Abteilung X, Henschelstr. 20-30, D-32257 Bünde** (nur für DE, AT, NL, BE, LU, ES, IT, PL, US, CA). Für alle übrigen Länder kontaktieren Sie ausschließlich Ihren Händler oder Distributor.

EN Customer Service: www.revell-service.de/en or **Carrera Revell UK Ltd, Unit 10, Old Airfield Industrial Estate, Cheddington Lane, Tring HP27 4QR, United Kingdom** (only for United Kingdom and Ireland). For all other countries, please contact your dealer or distributor only.

FR Customer Service: www.revell-service.de/en or **Revell GmbH, Department X, Henschelstr. 20-30, D-32257 Bünde, Germany** (only for DE, AT, NL, BE, LU, ES, IT, PL, US, CA). For all other countries please contact your dealer or distributor only.

FR Service clientèle: www.revell-service.de/fr (uniquement pour la France). Pour tous les autres pays, veuillez contacter votre revendeur ou distributeur uniquement.

NL Klantenservice: www.revell-service.de of **Revell GmbH, Abteilung X, Henschelstr. 20-30, D-32257 Bünde** (alleen voor DE, AT, NL, BE, LU, ES, IT, PL, US, CA). Voor alle andere landen kunt u alleen contact opnemen met uw dealer of distributeur.

ES Servicio al cliente: www.revell-service.de o **Revell GmbH, Abteilung X, Henschelstr. 20-30, D-32257 Bünde** (solo para DE, AT, NL, BE, LU, ES, IT, PL, US, CA). Para todos los demás países, por favor, póngase en contacto con su proveedor o distribuidor solamente.

IT Servizio clienti: www.revell-service.de o **Revell GmbH, Abteilung X, Henschelstr. 20-30, D-32257 Bünde** (solo per DE, AT, NL, BE, LU, ES, IT, PL, US, CA). Per tutti gli altri paesi si prega di contattare esclusivamente il proprio rivenditore o distributore.

PT Serviço de apoio ao cliente: www.revell-service.de ou **Revell GmbH, Abteilung X, Henschelstr. 20-30, D-32257 Bünde** (apenas para DE, AT, NL, BE, LU, ES, IT, PL, US, CA). Para todos os outros países, contacte apenas o seu revendedor ou distribuidor.

DK Kundenservice: www.revell-service.de eller **Revell GmbH, Abteilung X, Henschelstr. 20-30, D-32257 Bünde** (kun for DE, AT, NL, BE, LU, ES, IT, PL, US, CA). For alle øvrige lande bedes du udelukkende kontakte din forhandler eller distributor.

NO Kundenservice: www.revell-service.de eller **Revell GmbH, Abteilung X, Henschelstr. 20-30, D-32257 Bünde** (kun for DE, AT, NL, BE, LU, ES, IT, PL, US, CA). For alle andre land gjelder at all kontakt skal skje via din forhandler eller distributor.

SE Kundtjänst: www.revell-service.de eller **Revell GmbH, Abteilung X, Henschelstr. 20-30, D-32257 Bünde** (endast för DE, AT, NL, BE, LU, ES, IT, PL, US, CA). För övriga länder var god kontakta återförsäljaren eller distributören.

FI Asiakaspalvelu: www.revell-service.de tai **Revell GmbH, Abteilung X, Henschelstr. 20-30, D-32257 Bünde** (vain DE, AT, NL, BE, LU, ES, IT, PL, US, CA). Muuten maiden kohdalla ota yhteyttä paikalliseen jälleenmyyjään tai jakelijaan.

RU Служба поддержки клиентов: www.revell-service.de или **Revell GmbH, Abteilung X, Henschelstr. 20-30, D-32257 Bünde** (только для DE, AT, NL, BE, LU, ES, IT, PL, US, CA). Клиентам из других стран следует обращаться исключительно к своему поставщику или дистрибьютору.

PL Dział obsługi klienta: www.revell-service.de lub **Revell GmbH, Abteilung X, Henschelstr. 20-30, D-32257 Bünde** (tylko dla DE, AT, NL, BE, LU, ES, IT, PL, US, CA). We wszystkich pozostałych krajach należy kontaktować się wyłącznie ze sprzedawcą lub dystrybutorem.

CZ Zákaznický servis: www.revell-service.de nebo **Revell GmbH, Abteilung X, Henschelstr. 20-30, D-32257 Bünde** (pouze pro DE, AT, NL, BE, LU, ES, IT, PL, US, CA). Pro všechny ostatní země kontaktujte výlučně svého obchodníka nebo prodejce.

HU Ügyfélszolgálat: www.revell-service.de vagy **Revell GmbH, Abteilung X, Henschelstr. 20-30, D-32257 Bünde** (csak DE, AT, NL, BE, LU, ES, IT, PL, US, CA országok esetében). Az egyéb országok esetének kizárólag kereskedőjével, vagy forgalmazójával vegye fel a kapcsolatot.

SK Zákaznícky servis: www.revell-service.de alebo **Revell GmbH, Abteilung X, Henschelstr. 20-30, D-32257 Bünde** (iba pre DE, AT, NL, BE, LU, ES, IT, PL, US, CA). Pre všetky ostatné krajiny kontaktujte výlučne svojho obchodníka alebo predajcu.

RO Serviciul clienți: www.revell-service.de sau **Revell GmbH, Abteilung X, Henschelstr. 20-30, D-32257 Bünde** (doar pentru DE, AT, NL, BE, LU, ES, IT, PL, US, CA). Pentru toate celelalte țări contactați doar comerciantul dvs. sau distribuitorul.

BG Отдел за обслужване на клиенти: www.revell-service.de или **Revell GmbH, Abteilung X, Henschelstr. 20-30, D-32257 Bünde** (само за DE, AT, NL, BE, LU, ES, IT, PL, US, CA). За всички останали държави се свързвайте само с Вашия дилър или дистрибутор.

SI Služba za pomoč strankam: www.revell-service.de ali **Revell GmbH, Abteilung X, Henschelstr. 20-30, D-32257 Bünde** (samo za DE, AT, NL, BE, LU, ES, IT, PL, US, CA). Za vse ostale države se obrnite samo na prodajalca ali distributerja.

GR Τμήμα εξυπηρέτησης πελατών: www.revell-service.de ή **Revell GmbH, Abteilung X, Henschelstr. 20-30, D-32257 Bünde** (μόνο για DE, AT, NL, BE, LU, ES, IT, PL, US, CA). Για όλες τις άλλες χώρες επικοινωνήστε αποκλειστικά με τον έμπορο ή τον αντιπρόσωπο της περιοχής σας.

TR Müşteri hizmetleri: www.revell-service.de veya **Revell GmbH, Abteilung X, Henschelstr. 20-30, D-32257 Bünde** (sadece DE, AT, NL, BE, LU, ES, IT, PL, ABD, CA için). Tüm diğer ülkeler için sadece satıcıya veya distribütörünüze başvurun.

1

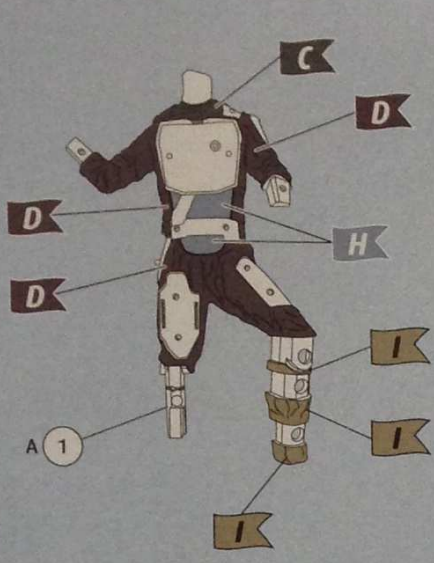

2

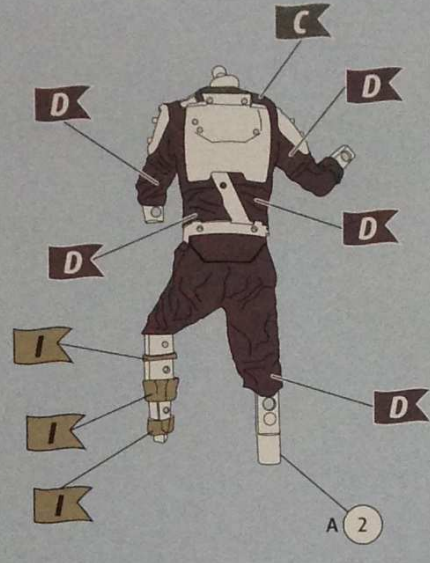

3

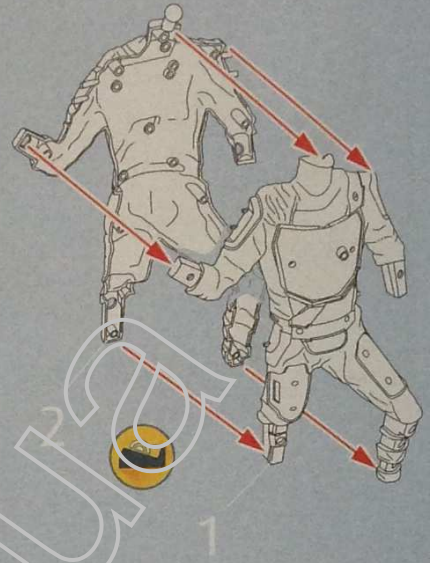

4

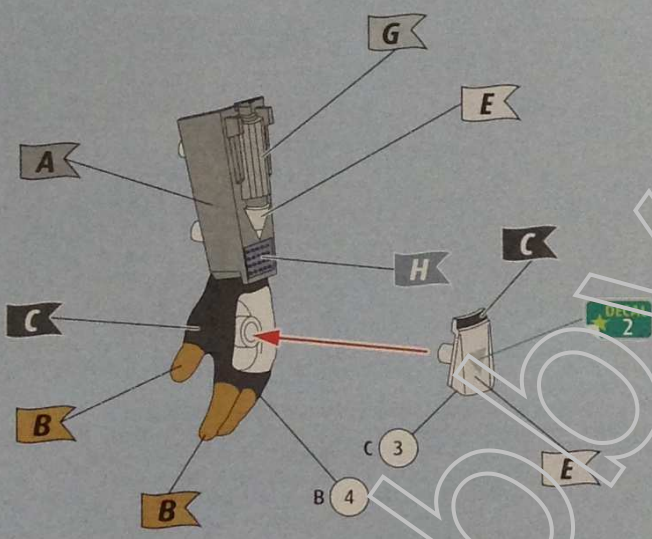

5

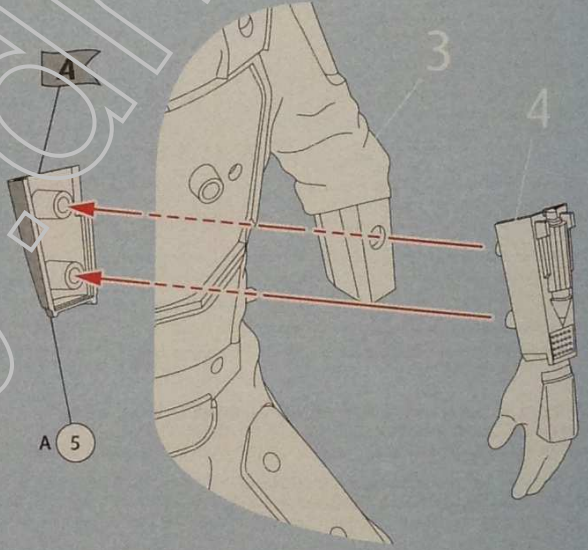

6

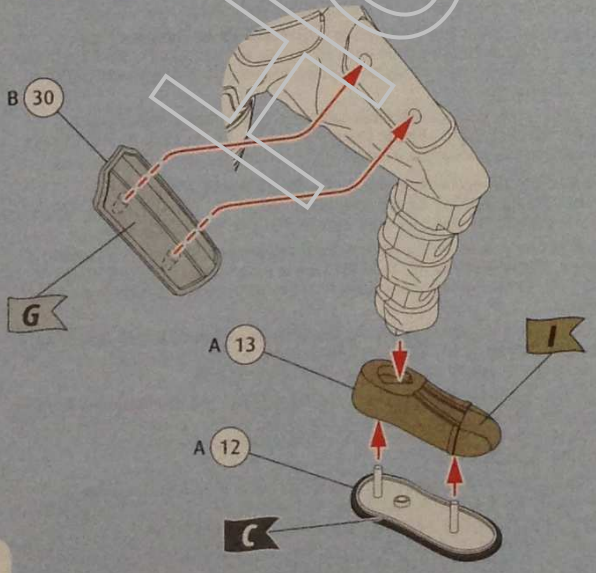

7

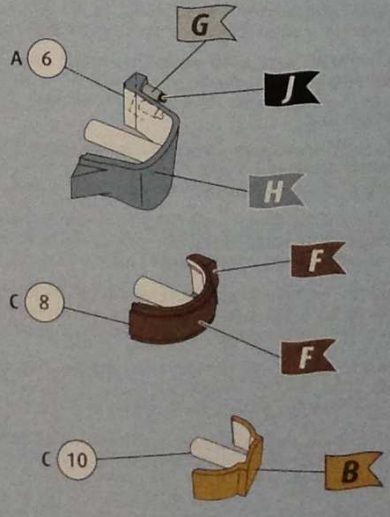

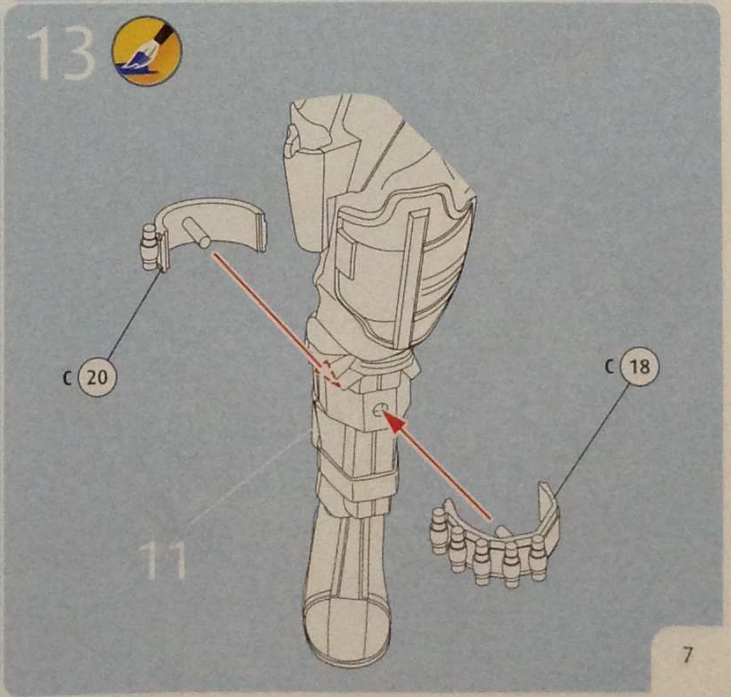
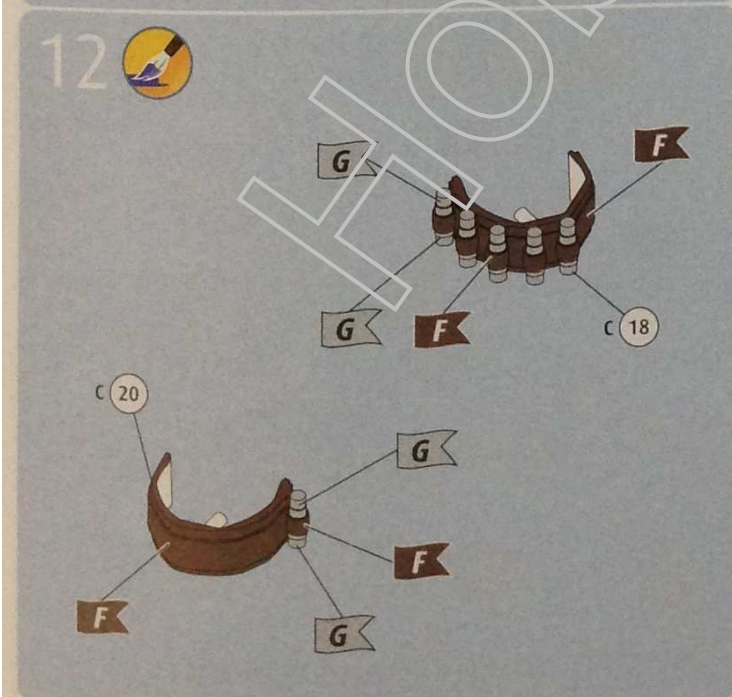
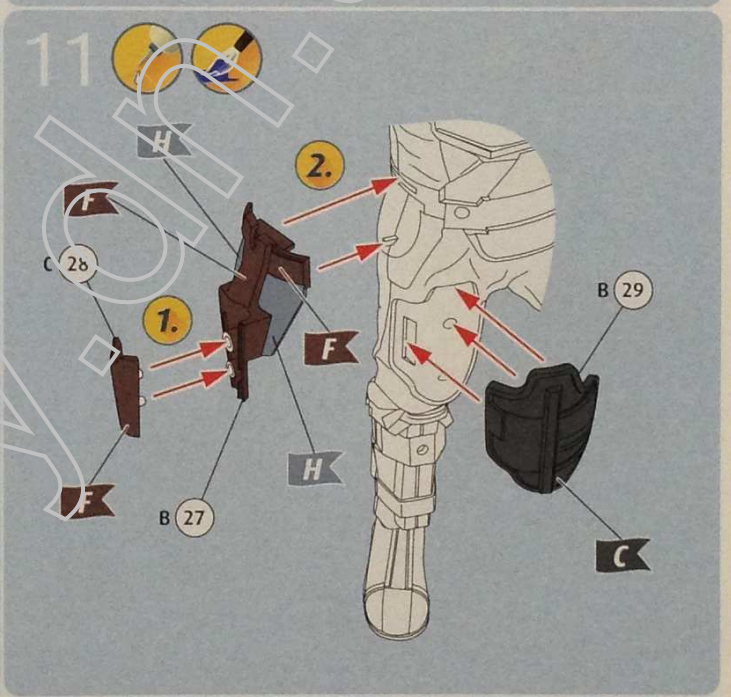
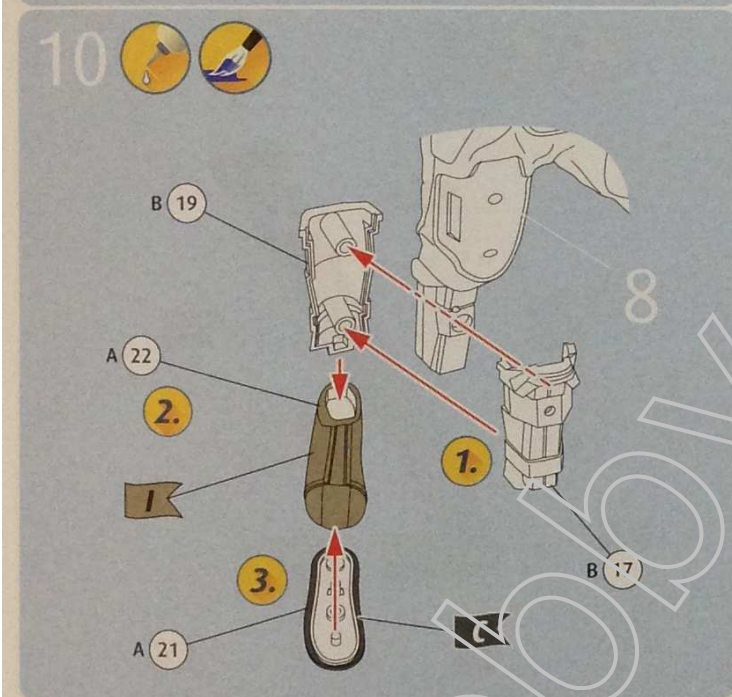
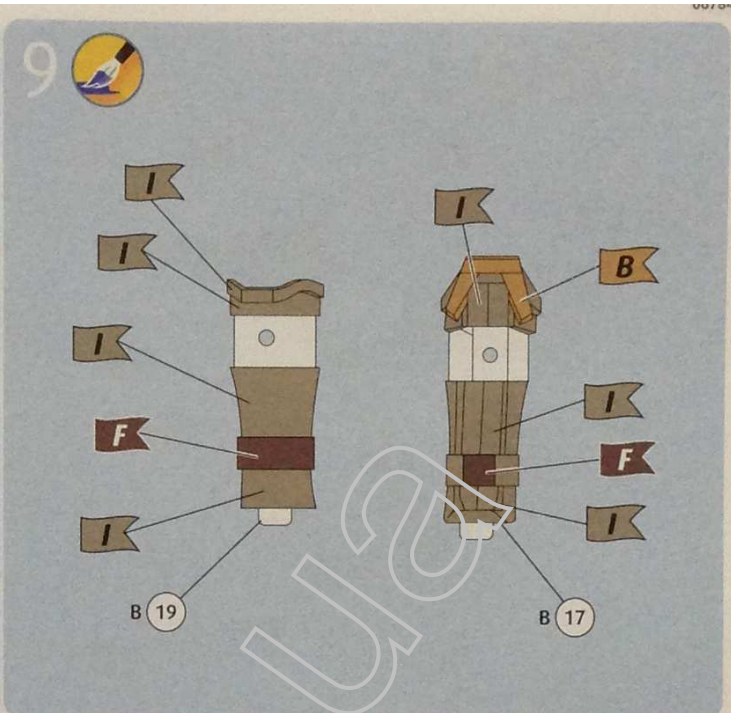
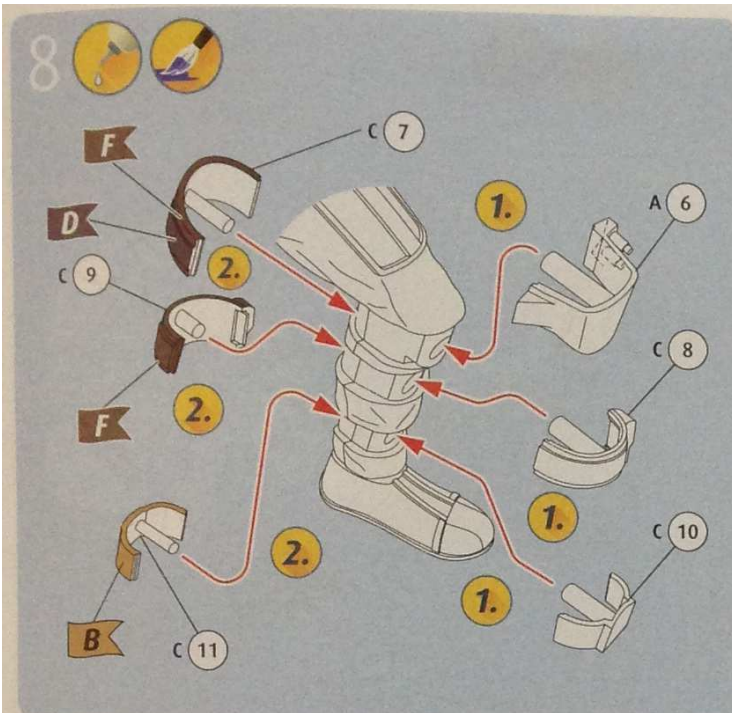

14

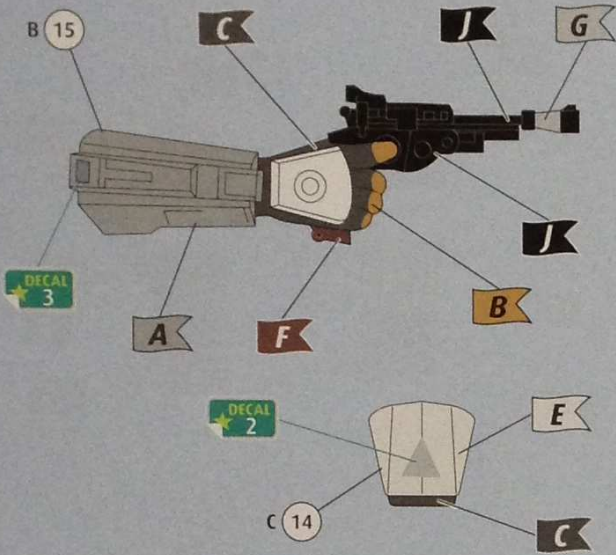

15

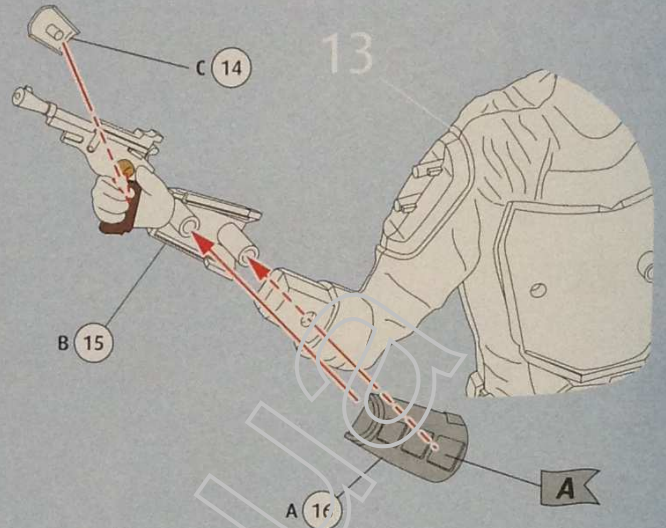

16

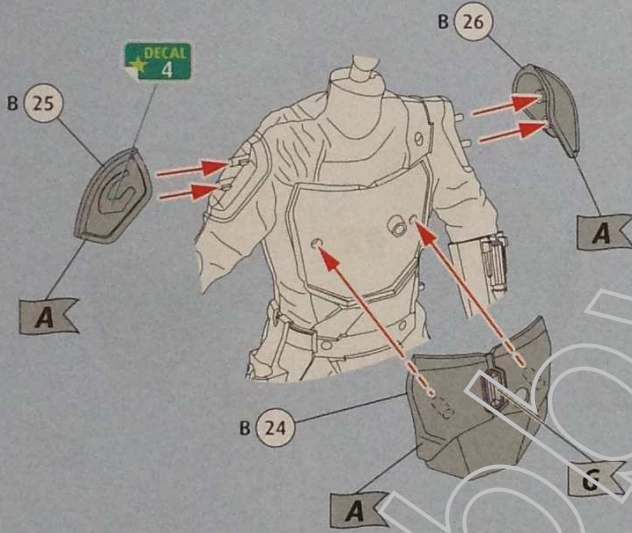

17

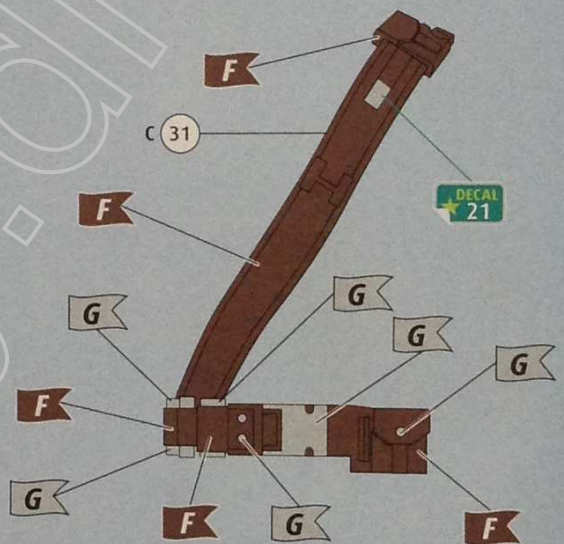

18

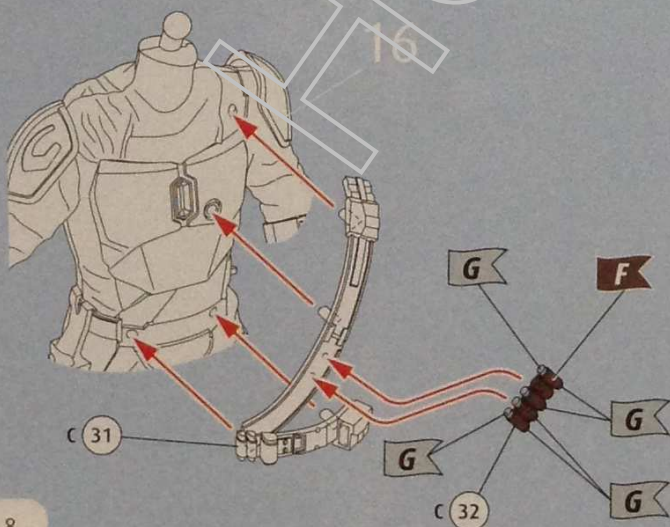

19

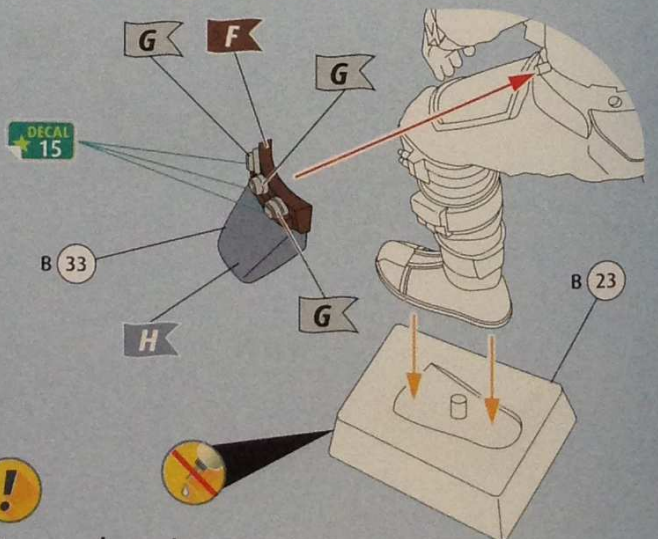

Use only when colours are drying !

20  

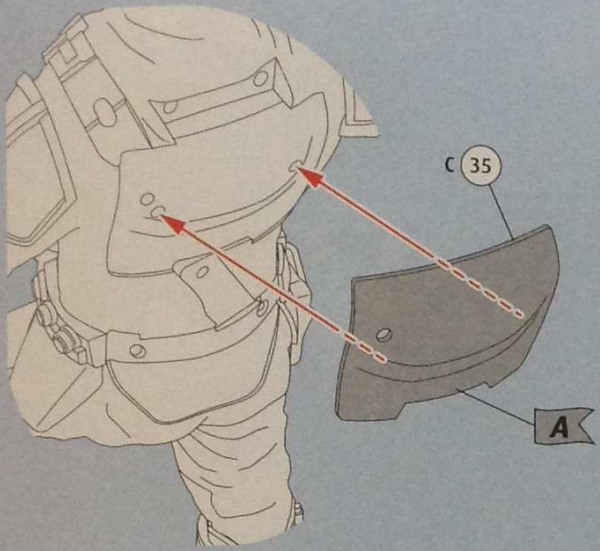

21 

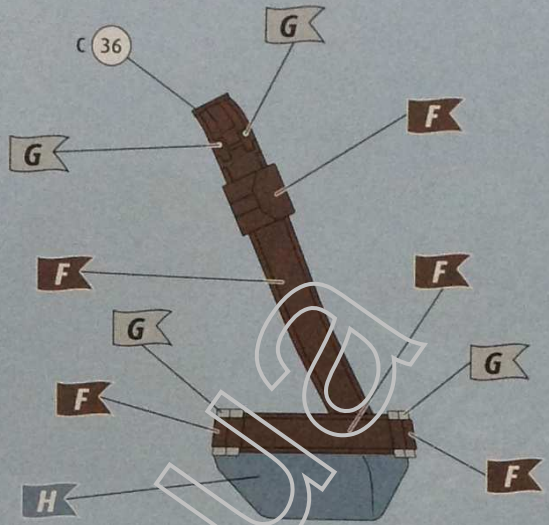

22  

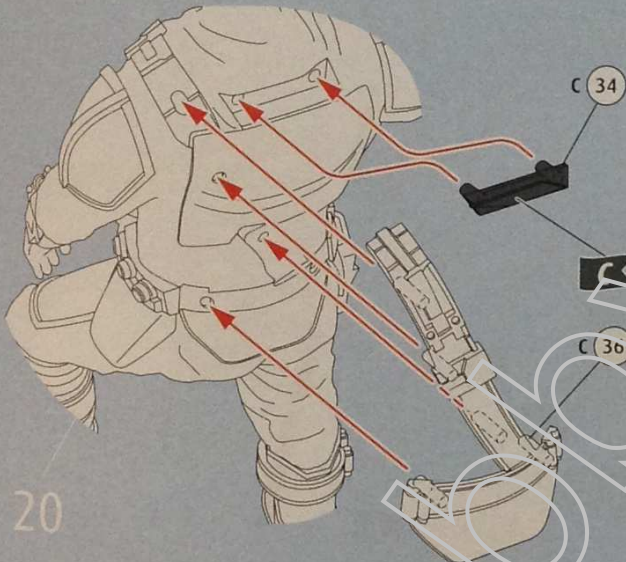

23 

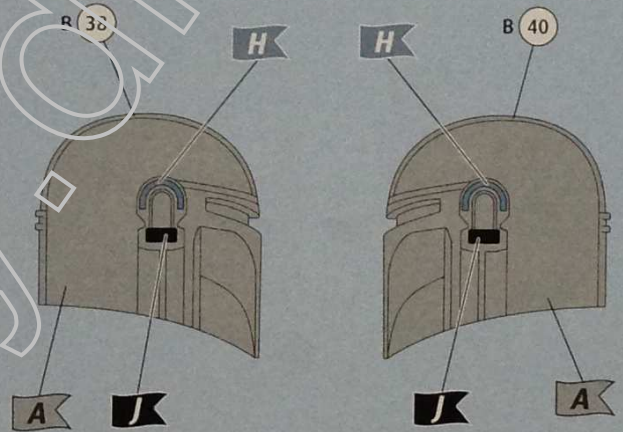

24 

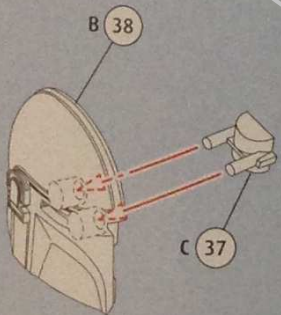

25 

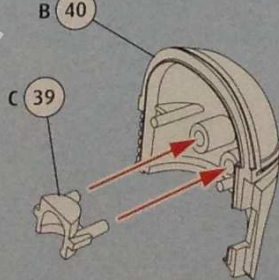

26  

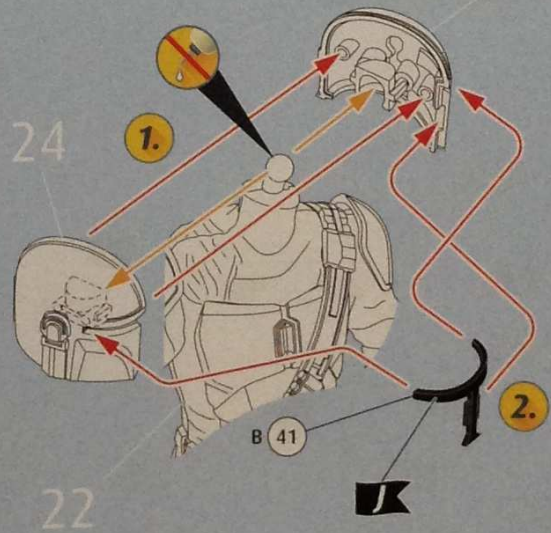

27

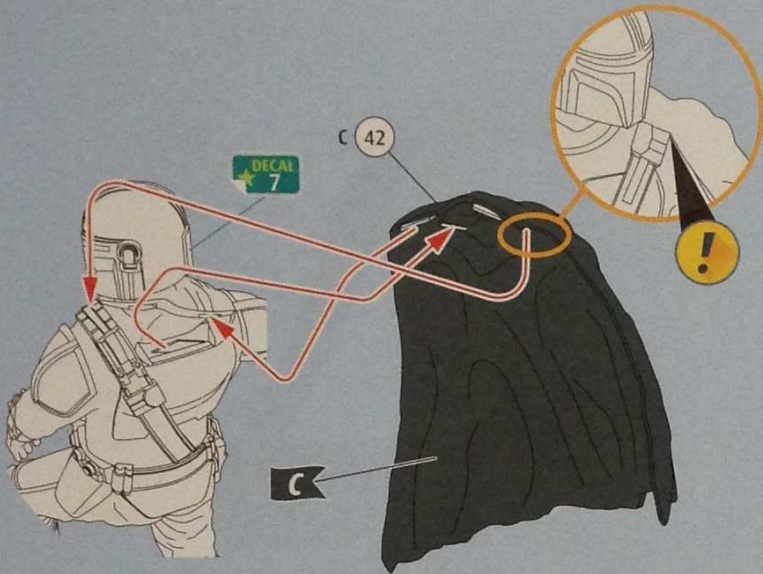

28

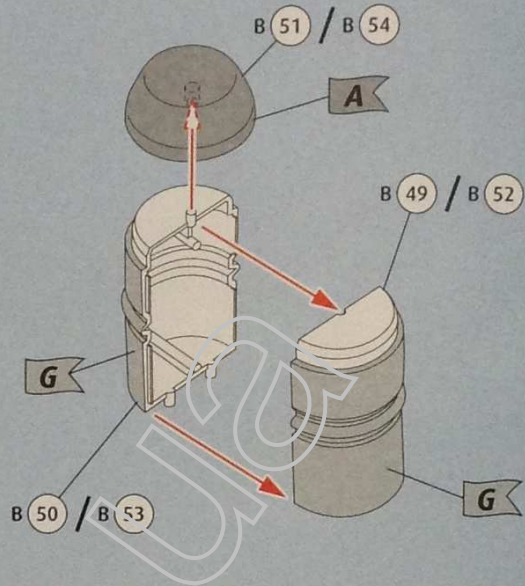

29

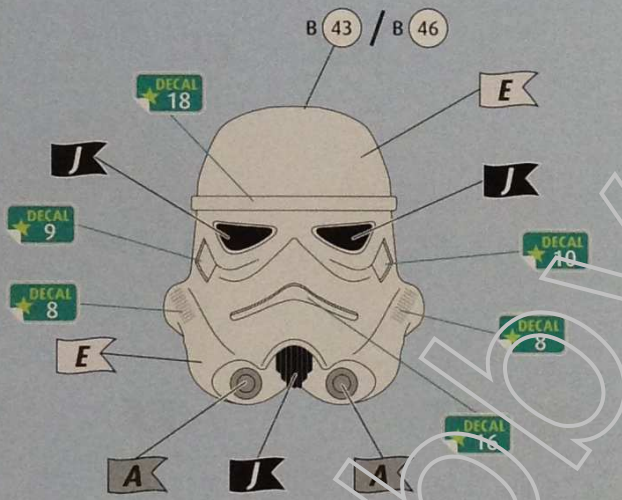

30

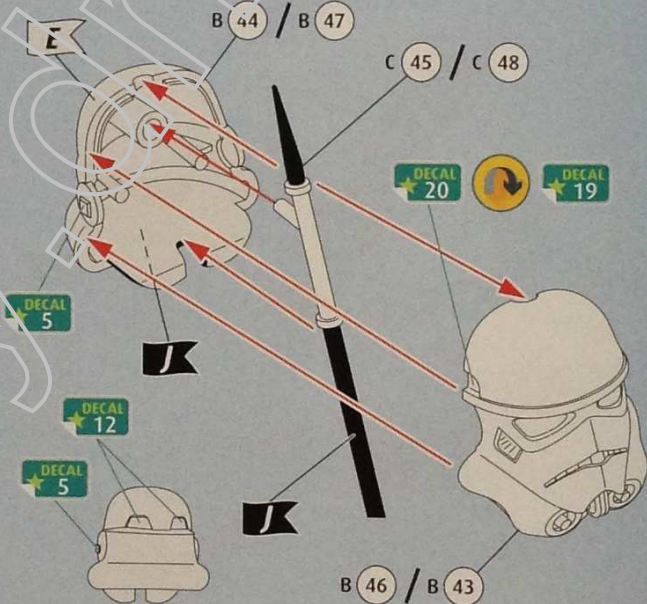

31

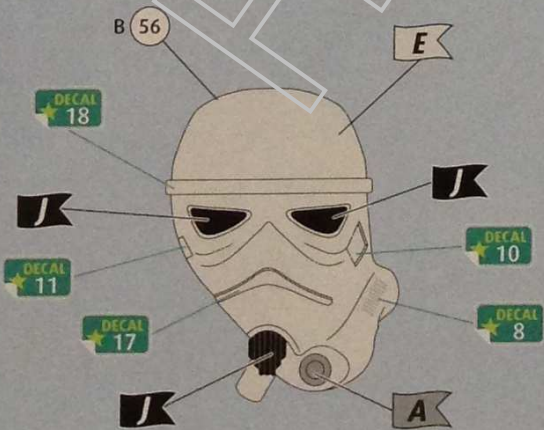

32

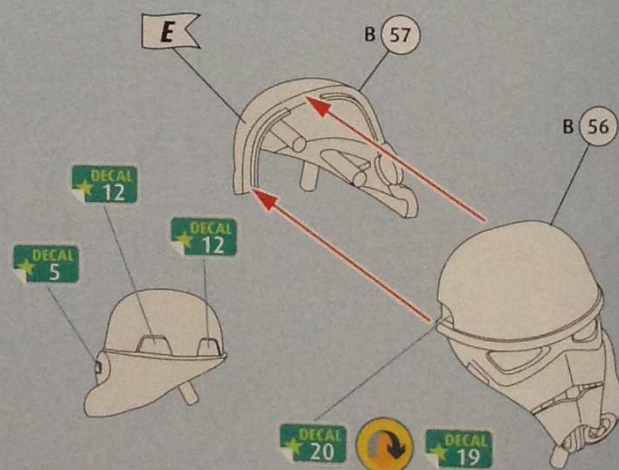

33   

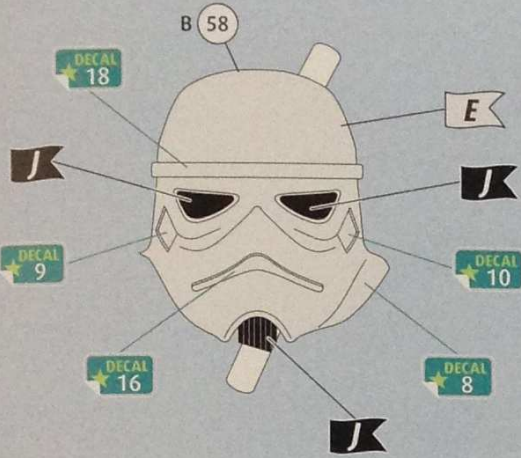

34   

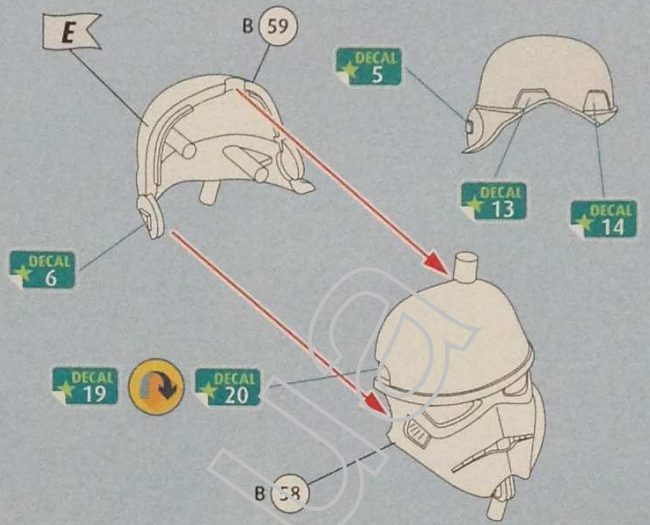

35   

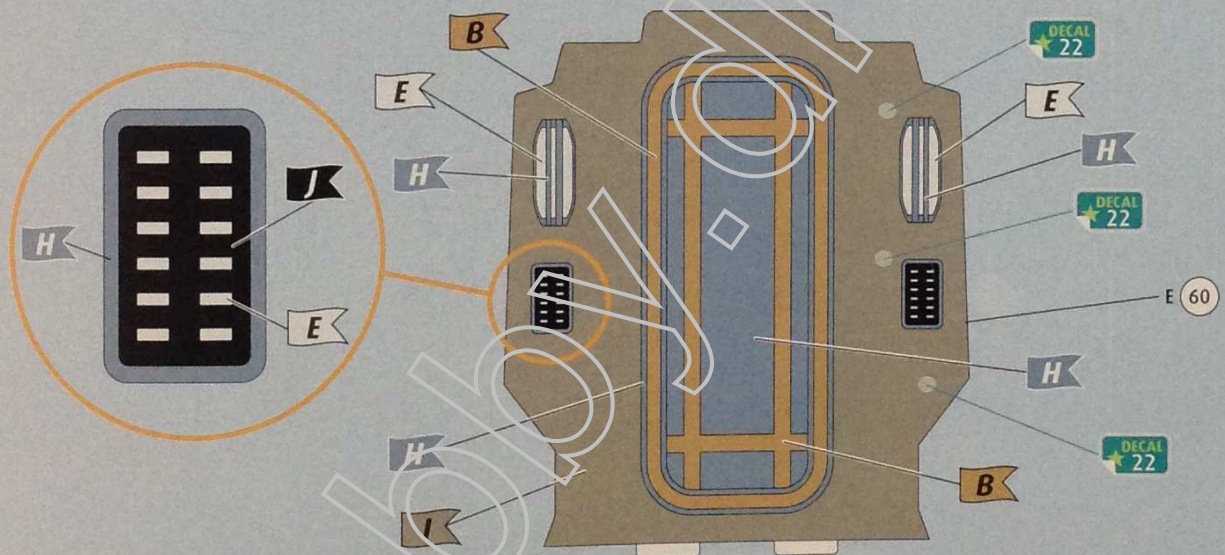

36     

