

Revell

Volkswagen T3 „Camper“

07344-0389

©2010 by REVELL GmbH & Co. KG.

PRINTED IN GERMANY



Volkswagen T3 „Camper“

Der sparsame, zuverlässige Kleintransporter T3 wurde ab 1979 hergestellt. VW behielt das schon bei den beiden Vorgängern bewährte Konzept bei. Allerdings handelte es sich nicht wie bei dem T2 um eine Weiterentwicklung, sondern um ein völlig neu entwickeltes Modell. Neben der größeren Karosserie mit seiner modernen, zweckmäßigen Formgebung bot der T3 technische Neuerungen, unter anderem die Zahnstangenlenkung sowie Schraubenfedern vorne und hinten und die ab 1982 zur Verfügung stehenden, wassergekühlten Motoren (erkennbar an dem zusätzlichen Grill oberhalb der vorderen Stoßstange). Der Wagen war sichtlich geräumiger als sein Vorgänger: der Radstand und die Gesamtlänge nahmen um 6 Zentimeter zu, die Breite um gut 12 Zentimeter und die Höhe dank des abgesenkten Laderaums um 10 Zentimeter. Das robuste Fahrzeug besaß den Motor weiterhin im Heck. Je nach Ausführung bot der Vierzylinder 50 bis 112 PS Leistung. Der T3 war der letzte von VW hergestellte Typ mit einem Heckmotor, so dass er als der letzte „echte“ Bulli angesehen wurde. Wie üblich erschien der Transporter in verschiedenen Nutzfahrzeug-Versionen, darunter als Kombi, Pritschen- oder Verkaufswagen, aber auch in Form des Klein- und Campingbusses für private Zwecke. Verschiedene Campingfahrzeugausstatter boten Umbauten für den T3 an, wobei insbesondere die erfolgreiche Version des „Joker“, die VW von der in Gütersloh ansässigen Firma Westfalia als Innenausstattung in sein Sortiment nahm, großen Anklang fand. Der Westfalia Joker eignete sich hervorragend als Multifunktionsfahrzeug für den Weg zur Arbeit, für den täglichen Gebrauch, aber auch für längere Urlaubsfahrten. Über 70.000 verkaufte Exemplare belegen die große Beliebtheit dieses „Heims auf Rädern“ im In- und Ausland, auch dank der strengen Sicherheitsnormen der Westfalia-Wohnmobile. Sein bequemer Wohnraum mit integriertem Fahrerhaus verfügte über eine komplette Kücheneinheit, Sitz- und Liegeflächen, Stauschränke und wurde durch das praktische Aufstellfach beträchtlich vergrößert.

Volkswagen T3 „Camper“

This economical, reliable little transporter T3 was made from 1979 onwards. VW retained the tried and tested concept of its two predecessors. However, it was not a further development like the T2, but a completely new model. In addition to the larger body with its practical modern shape, the T3 offered technical innovations, including the rack and pinion steering, front and rear coil springs and water-cooled engines (recognizable from the additional grille over the front bumper), that were available from 1982. The vehicle was visibly roomier than its predecessor: the wheelbase and the overall length were increased by 6 cm, the width by a good 12 cm and the height, thanks to the lowering of the load space by 10 cm. This robust vehicle still had a rear engine. The 4-cylinder engine offered a capacity of 50 to 112 bhp according to the version. The T3 was the last type made by VW with a rear engine, so that it was regarded as the last real "bully". As usual the transporter appeared in various commercial vehicle versions, including estate car, platform truck, mobile shop, and also in the form of the minibus and camper for private use. Various firms of camper fitters offered interiors for the T3, one of which, the particularly successful "Joker" version from the Westfalia company in Gütersloh that was included in the VW range, was very favorably received.

The Westfalia Joker was eminently suitable as a multi-function vehicle for traveling to work, for routine daily use and also for longer holiday journeys. Sales in excess of 70,000 at home and abroad vouch for the great popularity for this "home on wheels", not least due to the strict safety standards of Westfalia mobile homes. The comfortable living space with integral driver's cab had a complete kitchen unit, seats and beds, storage cupboards and was considerably increased in size by the practical rising roof.

Foto: ingegneri e in Eigenum von Revell GmbH & Co. KG. Wiederholte Nachnahmen werden gütlich erwidert.
Ce produs este proprietate de la societate Revell GmbH & Co. KG. Toate afişările sau duplicările înalte fără Faşă de pe această se sunt

Modelul este produs de la societate Revell GmbH & Co. KG. Toate afişările sau duplicările înalte fără Faşă de pe această se sunt

Modelul este produs de la societate Revell GmbH & Co. KG. Toate afişările sau duplicările înalte fără Faşă de pe această se sunt

Modelul este produs de la societate Revell GmbH & Co. KG. Toate afişările sau duplicările înalte fără Faşă de pe această se sunt

Modelul este produs de la societate Revell GmbH & Co. KG. Toate afişările sau duplicările înalte fără Faşă de pe această se sunt

Modelul este produs de la societate Revell GmbH & Co. KG. Toate afişările sau duplicările înalte fără Faşă de pe această se sunt

Modelul este produs de la societate Revell GmbH & Co. KG. Toate afişările sau duplicările înalte fără Faşă de pe această se sunt

Modelul este produs de la societate Revell GmbH & Co. KG. Toate afişările sau duplicările înalte fără Faşă de pe această se sunt

Modelul este produs de la societate Revell GmbH & Co. KG. Toate afişările sau duplicările înalte fără Faşă de pe această se sunt

Modelul este produs de la societate Revell GmbH & Co. KG. Toate afişările sau duplicările înalte fără Faşă de pe această se sunt

Modelul este produs de la societate Revell GmbH & Co. KG. Toate afişările sau duplicările înalte fără Faşă de pe această se sunt

Modelul este produs de la societate Revell GmbH & Co. KG. Toate afişările sau duplicările înalte fără Faşă de pe această se sunt

Modelul este produs de la societate Revell GmbH & Co. KG. Toate afişările sau duplicările înalte fără Faşă de pe această se sunt

Modelul este produs de la societate Revell GmbH & Co. KG. Toate afişările sau duplicările înalte fără Faşă de pe această se sunt

Modelul este produs de la societate Revell GmbH & Co. KG. Toate afişările sau duplicările înalte fără Faşă de pe această se sunt

Este produs de la societate Revell GmbH & Co. KG. Toate afişările sau duplicările înalte fără Faşă de pe această se sunt

Este produs de la societate Revell GmbH & Co. KG. Toate afişările sau duplicările înalte fără Faşă de pe această se sunt

Este produs de la societate Revell GmbH & Co. KG. Toate afişările sau duplicările înalte fără Faşă de pe această se sunt

Este produs de la societate Revell GmbH & Co. KG. Toate afişările sau duplicările înalte fără Faşă de pe această se sunt

Este produs de la societate Revell GmbH & Co. KG. Toate afişările sau duplicările înalte fără Faşă de pe această se sunt

Este produs de la societate Revell GmbH & Co. KG. Toate afişările sau duplicările înalte fără Faşă de pe această se sunt

Este produs de la societate Revell GmbH & Co. KG. Toate afişările sau duplicările înalte fără Faşă de pe această se sunt

Este produs de la societate Revell GmbH & Co. KG. Toate afişările sau duplicările înalte fără Faşă de pe această se sunt

Este produs de la societate Revell GmbH & Co. KG. Toate afişările sau duplicările înalte fără Faşă de pe această se sunt

Este produs de la societate Revell GmbH & Co. KG. Toate afişările sau duplicările înalte fără Faşă de pe această se sunt

Este produs de la societate Revell GmbH & Co. KG. Toate afişările sau duplicările înalte fără Faşă de pe această se sunt

Este produs de la societate Revell GmbH & Co. KG. Toate afişările sau duplicările înalte fără Faşă de pe această se sunt

Este produs de la societate Revell GmbH & Co. KG. Toate afişările sau duplicările înalte fără Faşă de pe această se sunt

Este produs de la societate Revell GmbH & Co. KG. Toate afişările sau duplicările înalte fără Faşă de pe această se sunt

Este produs de la societate Revell GmbH & Co. KG. Toate afişările sau duplicările înalte fără Faşă de pe această se sunt

Este produs de la societate Revell GmbH & Co. KG. Toate afişările sau duplicările înalte fără Faşă de pe această se sunt

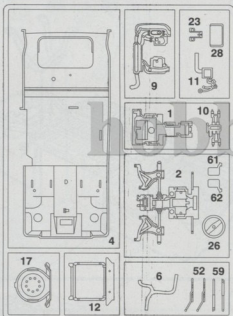
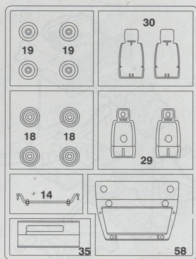
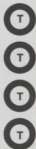
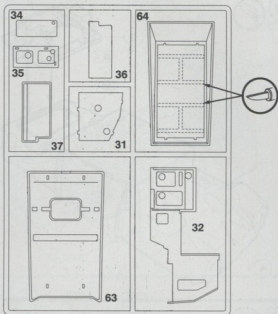

Nicht benötigte Teile
 Parts not used
 Pièces non utilisées
 Niet benötigte onderdelen
 Piezas no necesarias
 Peças não utilizadas
 Partii non usate
 Teile anforderd
 Tarpeifomat osat
 Nieo nødvendige dele
 Deler som ikke er nødvendige
 Hisszelektronika alkatrészei
 Elektricitij nepotrebovane
 Anlj spozivljive delovi
 Gerekli olmayan parçalar
 Nepotrebnije deli
 Nel nemű használat alkatrészek
 Nepotrebiti deli

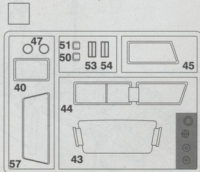
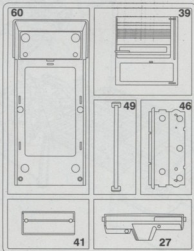
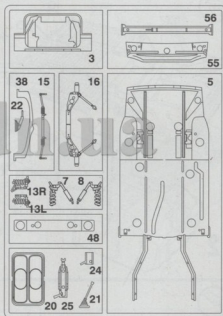

1

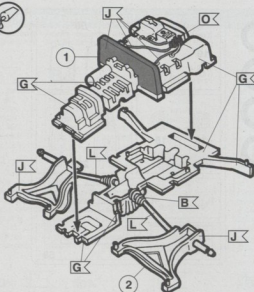

2

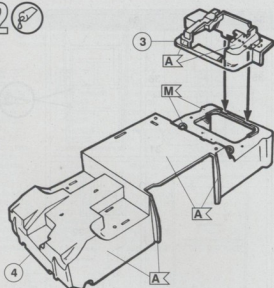

3

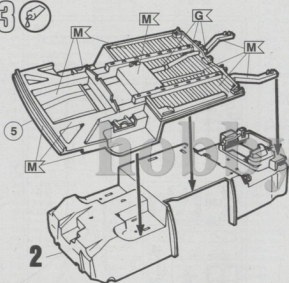

4

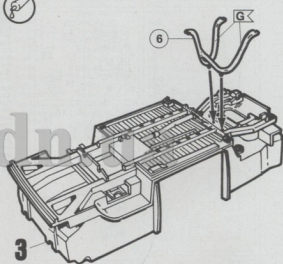

5

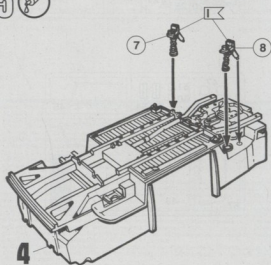

6

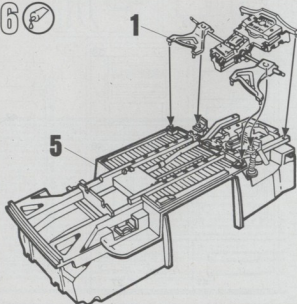

7

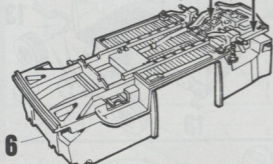

8

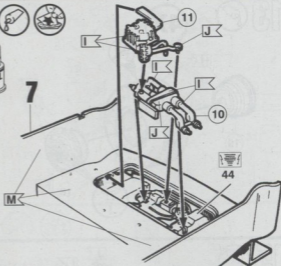

9

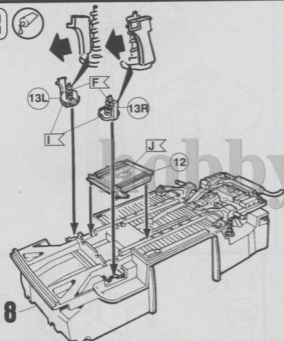

10

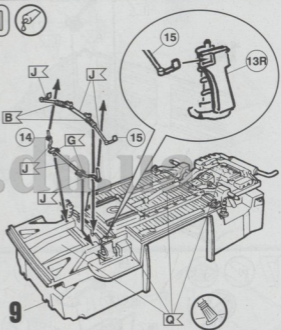

11

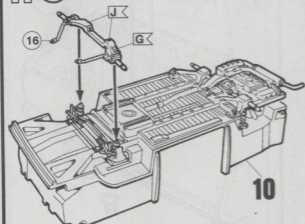

12

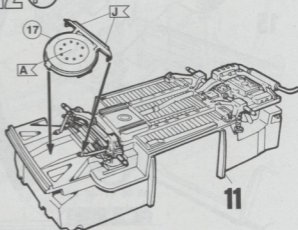

13

4X

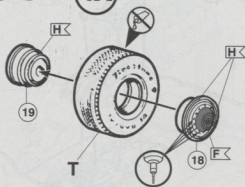

14

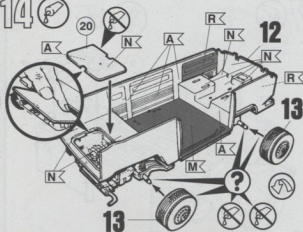

15

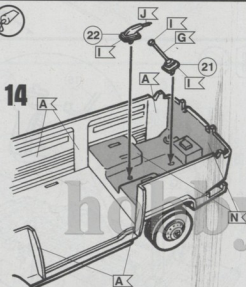

16

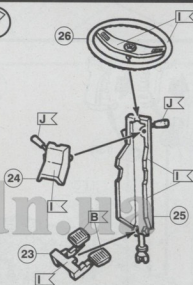

17

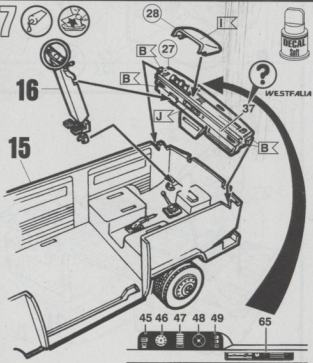

18

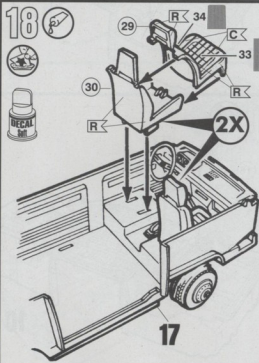

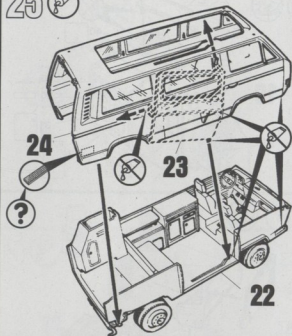
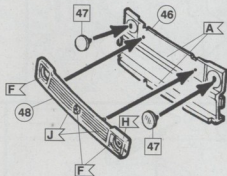
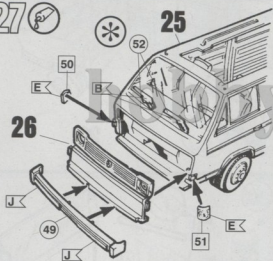
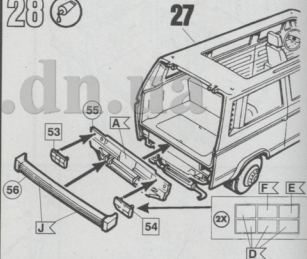
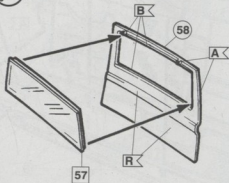
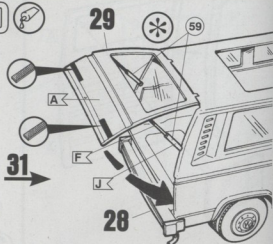
25 26 27 28 29 30 

31 



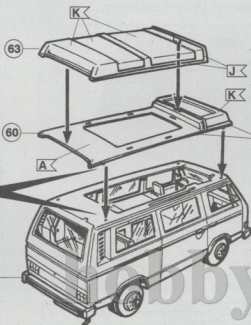

?

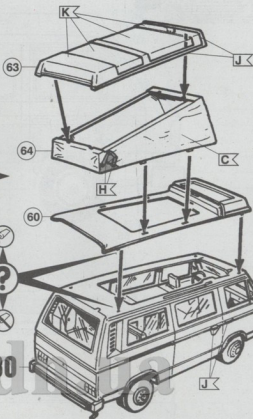

30

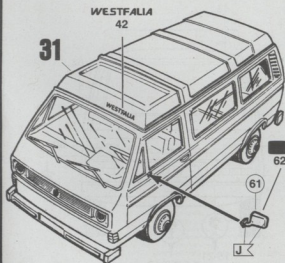

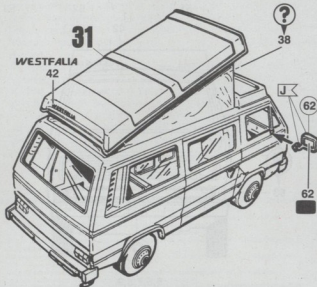
30

32  33  

34

