

ACADEMY

U.S. NAVY GUIDED MISSILE FRIGATE USS OLIVER HAZARD PERRY FFG-7

HOBBY MODEL KITS

14102

미해군 미사일 프리깃
올리버 해저드 페리



1/350th Scale

<READ THIS BEFORE YOU BEGIN>
 Study the instructions before assembling. - Check the fit of each piece before cementing into place.
 Do not use too much cement to join parts. - Never use cement or paint not open flame.
 Open a window or make sure area well ventilated when cement or paint is in use.
 Tear up and throw away the empty plastic bags to avoid danger of suffocation for little children.

<ALLGEMEINE HINWEISE>

Die Anordnung der Bauteile ist aus den Zeichnungen der Anleitung ersichtlich.
 Die Teile vor dem Verleimen sorgfältig zusammenhalten, um einen perfekten Sitz zu prüfen.
 Klebstoff nicht zu dick auftragen. - Klebstoff und Farben niemals in der Nähe einer Flamme verwenden.
 Während der Bemalung mit Spritzspule oder Pinsel für frische Luftzufuhr, z.B. Öffnen des Fensters, sorgen.
 Bauteile von kleinen Kindern fernhalten. Verboten ist, daß Kinder irgendwelche Bauteile in den Mund nehmen oder Plastikbeutchen über den Kopf ziehen.

■ 조립하기 전에

-부품을 조립하기 전에 설명서를 잘 읽어보 후 조립한다.
 -조립하기 전에 부품을 잘 섞어 확인한 후 조립한다.

-부품을 지를 때에는 언제나 나사못 key인 확인한다.
 -이제 제번이나 접착제를 사용할 때는 청운을 열어 환기를 시키고 화기를 끄는다.



READ THIS BEFORE YOU BEGIN
 ALLGEMEINE HINWEISE
 READ THIS BEFORE YOU BEGIN
 ALLGEMEINE HINWEISE

<LIRE CE QUI SUIT AVANT DE COMMENCER LE MONTAGE>

Etudier les schémas d'assemblage. - Contrôler que chaque pièce soit bien conforme avant de la coller à sa place.
 Ne pas utiliser trop de colle pour réunir les pièces. - Ne jamais manipuler la colle ou peindre à proximité d'une flamme.
 Appliquer abondamment la colle ou la résine (progressivement la brûler).
 Après avoir ouvert les emballages il faut en conséquence, éliminer le sac afin d'éviter que les enfants ne le mettent sur la tête et ne s'étouffent.

(組み立てる前に)

組み立てる前に説明書をお読み下さい。 - 部品をランナーから取り出す時は説明書のコピーをエッシャーで取り出し、必ず、接着剤を少ししか塗らずにしっかりと貼り付けてください。 - 接着する前に炎のそばに近づかずして乾かして下さい。
 接着剤や塗料を多用すると子どもが容易に頭で被る可能性があります。
 組み立てる前に袋やビニールを袋の中に入れておかないで燃かして下さい。



⚠️ 보호자 분들은 반드시 읽어 주십시오.

- 조립하기 전에 취급 설명서를 잘 읽어 내용을 충분히 이해한 상태에서 조립하여 주십시오.
- 부품을 지를 때는 해당번호를 확인한 뒤 나사 등으로 key인 확인한다.
- 접착제를 사용할 때는 청운을 열어 환기를 시키고 화기를 끄는다.
- 사용 후 남은 부품을 어린 아이들의 손에 닿지 않도록 잘 처리한다.
- 조립하기 전에 부품을 잘 섞어 확인한 후 조립한다.
- 이제 제번이나 접착제를 사용할 때는 청운을 열어 환기를 시키고 화기를 끄는다.
- 사용 후 남은 부품을 어린 아이들의 손에 닿지 않도록 잘 처리한다.

- Before starting to assemble, read the instruction manual very carefully to understand well everything of the instructions.
- Before cutting a part off sprue, check the part number again and use proper tool such as nipper to cut it clearly. Take care not to be hurt in case of modelling knife to cut or trim parts.
- Never put small parts in the mouth to avoid any danger of suffocation by accidentally swallowed ones. ● Never let children less than 3 years old have it to avoid any danger of taking it.
- The product may have some protruding parts for functional reasons and take care of handling it always.
- After cutting a part off sprue, trim it clearly to assemble and the wastes should be properly stored to dispose.
- Plastic bags packed with the product and parts should be disposed in a proper place immediately to keep out of children to avoid any danger of suffocation by pulling it over head or putting it over their face.
- Before using modelling colors or cement, open windows to keep the room well ventilated and do not use near fire or flame. After using them, keep in a proper place out of children.

**주의
WARNING!**

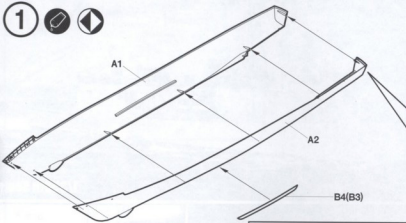
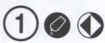

* () is opposite number.
()는 반대쪽 번호입니다.

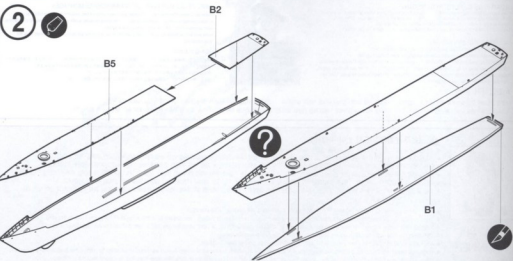
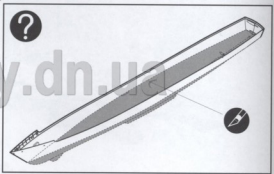
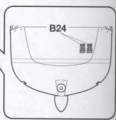

Hobby.dn.ua

3

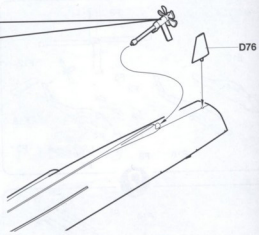
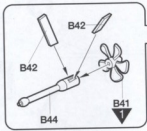

4

Hobbydunia

A

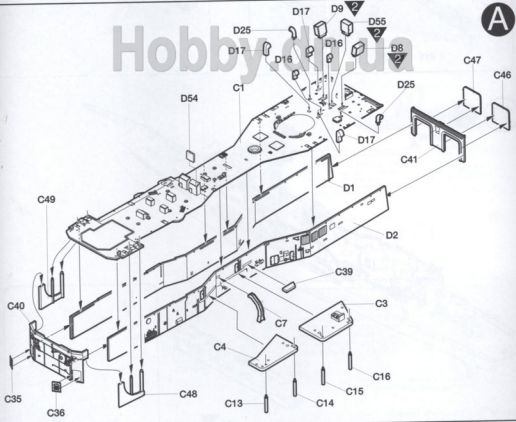

5

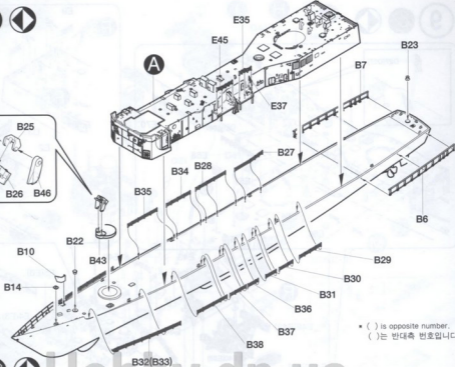
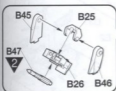

* () is opposite number.
()는 반대쪽 번호입니다.

6

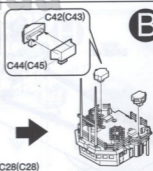
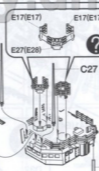
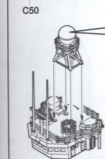
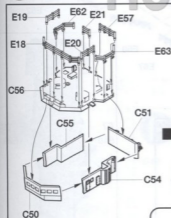

* () is opposite number.
()는 반대쪽 번호입니다.

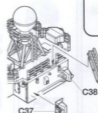
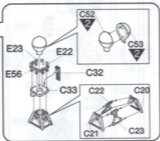

* () is opposite number.
()는 반대쪽 번호입니다.

7

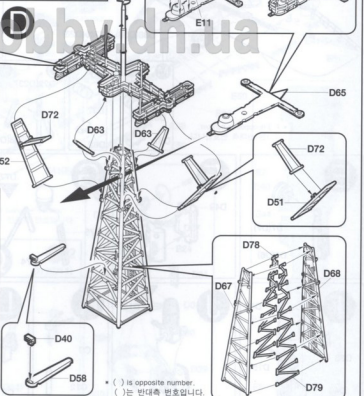
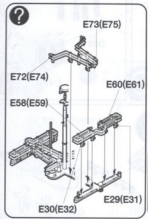
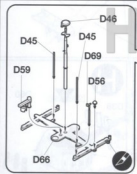
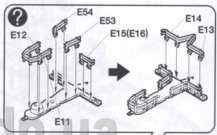
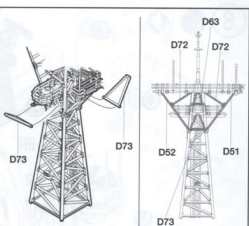
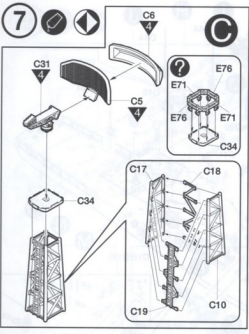

* () is opposite number.
 ()는 반대쪽 번호입니다.

8

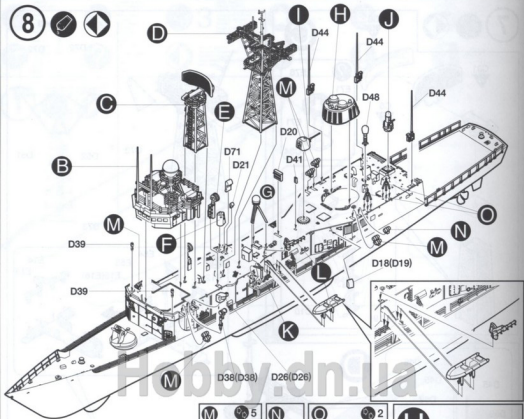

* () is opposite number.
()는 반대쪽 번호입니다.

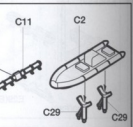
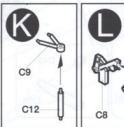
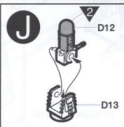
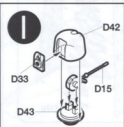
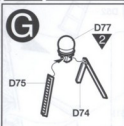
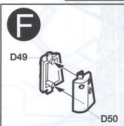
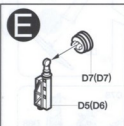
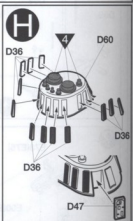

9

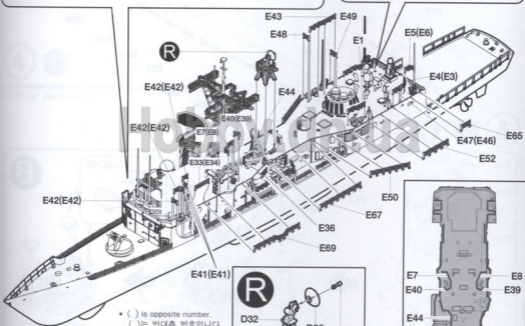
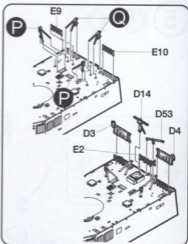
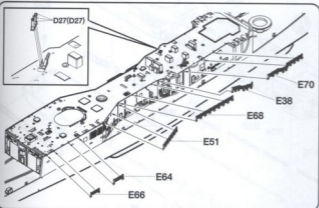

* () is opposite number.
()는 반대쪽 번호입니다.

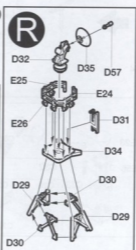
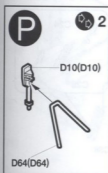
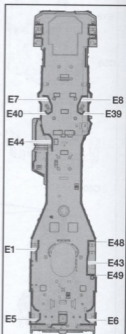

10 

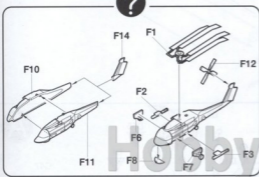
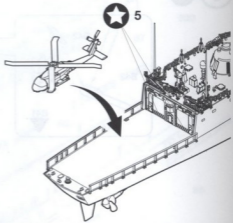
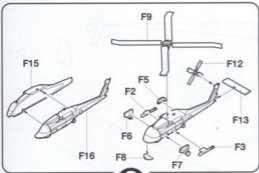

11 

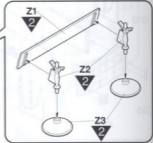
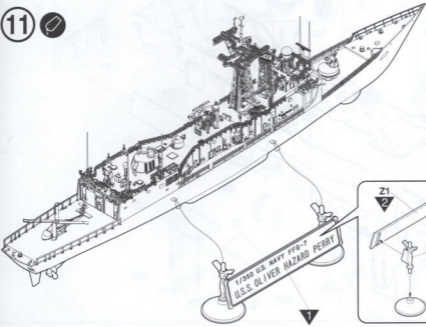

U.S. NAVY GUIDED MISSILE FRIGATE
USS OLIVER HAZARD PERRY FFG-7

14102

1/350th Scale

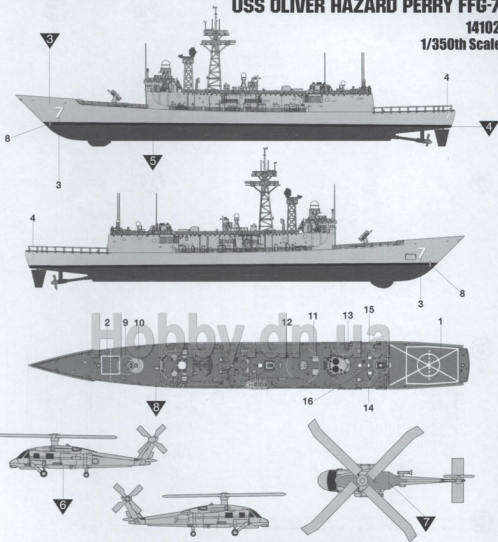

▽		GSI CREOS		LIFE COLOR	HUMBROL	MODEL MASTER		
		AQUEOUS HOBBY COLOR	Mr. COLOR			ENAMEL	ACRYL	
1	GOLD	9	9	LC75	16	1744		금색
2	FLAT WHITE	11	62	LC01	34	1768	4769	무광흰색
3	GRAY	61	35					회색
4	FLAT BLACK	12	33	LC02	33	1749	4768	무광검정색
5	HULL RED		29		60		4222	함저색
6	GRAY(FS36375)		308	UA026	127	1728	4762	라이트 고스트그레이
7	GRAY(FS36320)		307	UA027	128	1741	4761	다크 고스트그레이
8	GRAY GREEN		36		75			그레이 그린