

PLASTIC MODEL KITS
LIMITED EDITION

WIDTH : 50 mm
LENGTH : 107 mm
PARTS : 102 pieces
SCALE:1/72



In January 1964 the Soviet government issued a directive on the creation of the multi-purpose Ka-26 in two versions: the agricultural version capable of carrying 600..700 kg of chemicals and the transport version for carrying passengers over distances of up to 400 km. The first circuit flight of the Ka-26 took place on August 18, 1955; the prototype was flown by test pilot V.V.Gromov. The State trials were successfully completed in the autumn of 1967 and production was launched in the town of Kumertau at a factory, which had been purpose-built in 1962.

The helicopter Ka-26 was first demonstrated at the autumn exhibition in Moscow in 1965. Thanks to its efficient construction the helicopter could be easily transformed from the passenger version. The helicopter was widely used in the national economy of the USSR and was exported into many countries.

Technical and tactical specifications of Ka-26 :

Length	7,700 m	Maximum start weight	3060 kg	Ceiling	2100 m
Width	3,600 m	Maximum speed	170 kph		



В январе 1964 г. вышло правительственное постановление о создании многоцелевого Ка-26 в двух вариантах: сельскохозяйственном и транспортном - для перевозки шести пассажиров на дальность 400 км. Первый полет Ка-26 по кругу состоялся 18 августа 1965 г. пилотировал его лётчик-испытатель В.В.Громов. Осенью 1967 г. с положительными результатами завершились государственные испытания, и он был запущен в серийное производство в городе Кумертау.

Вертолет Ка-26 впервые был продемонстрирован на осенней выставке в Москве в 1965 году. Благодаря своей удачной конструкции и за счет съемных частей, вертолет легко переделывался из пассажирского варианта в сельскохозяйственный и в вариант с грузовой платформой. Вертолет нашел широкое применение в народном хозяйстве СССР и поставлялся на экспорт во многие страны.

Тактико-технические характеристики Ка-26 :

Длина	7,700 м	Максимальный взлетный вес	3060 кг	Потолок	2100 м
Ширина	3,600 м	Максимальная скорость	170 км/ч		

The model is executed on technology short run and is intended only for experienced modelers
Word-wide distributor for AMODEL kits : IBG, Warszawa, Poland
Fax:(4822)842-56-29 ; E-Mail:ibgsc@ibg.com.pl

Модель выполнена по технологии short run и предназначена только для опытных моделистов
Дистрибутор моделей AMODEL : IBG, Варшава, Польша
Факс:(4822) 842-56-29 ; E-Mail:ibgsc@ibg.com.pl

1
STAGES OF ASSEMBLY
ЭТАПЫ СБОРКИ
1
NUMBER PARTS
НОМЕР ДЕТАЛИ

TO PAINT
ОКРАСИТЬ
1
APPLY DECALS
НАНЕСТИ ДЕКАЛЬ

GLUE
КЛЕИТЬ

DON'T GLUE
НЕ КЛЕИТЬ

VERSION
ВАРИАНТ

MAKE A HOLE
ВЫПОЛНИТЬ ОТВЕРСТИЕ

DETACH WITH KNIFE
ОТДЕЛИТЬ НОЖОМ

SHAPE WITH HOT KNIFE
ФОРМОВАТЬ ГОРЯЧИМ
НОЖОМ
2x
QUANTITY OF
OPERATIONS (PARTS)
КОЛИЧЕСТВО
ОПЕРАЦИЙ (ДЕТАЛЕЙ)

OPTIONAL
НА ВЫБОР

HUMBROL 22
WHITE
БЕЛЫЙ

HUMBROL 47
SEA BLUE
ГОЛУБОЙ

HUMBROL 19
BRIGHT RED
КРАСНЫЙ

HUMBROL 40
PALE GREY
СЕРЫЙ

HUMBROL 2
EMERALD
ЗЕЛЕНЫЙ

HUMBROL 188
YELLOW
ЖЕЛТЫЙ

HUMBROL 33
BLACK
ЧЕРНЫЙ

HUMBROL 145
MEDIUM GREY
СРЕДНЕ СЕРЫЙ

HUMBROL 24
YELLOW
ЖЕЛТЫЙ

HUMBROL 64
LIGHT GREY
СВЕТЛО СЕРЫЙ

HUMBROL 88
DECK GREEN
ЗЕЛЕНЫЙ

HUMBROL 147
LIGHT GREY
СВЕТЛО СЕРЫЙ

HUMBROL 119
LIGHT EARTH
СВЕТЛО КОРИЧНЕВЫЙ

HUMBROL 53
GUN METAL
СТАЛЬНОЙ СЕРЫЙ

102 DETAILS FOR ASSEMBLY OF ONE MODEL

102 ДЕТАЛИ ДЛЯ СБОРКИ ОДНОЙ МОДЕЛИ

PARTS NOT FOR USE

ПРИ СБОРКЕ НЕ ИСПОЛЬЗУЮТСЯ

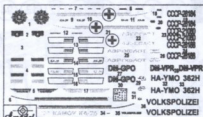
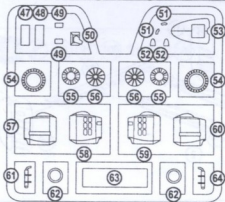
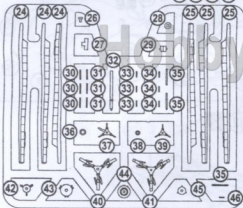
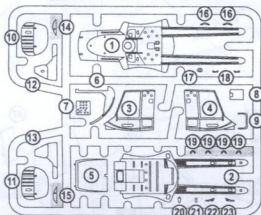

DECALS FOR FOUR VERSIONS OF COLOURING
ДЕКАЛЬ ДЛЯ ЧЕТЫРЕХ ВАРИАНТОВ ОКРАСКИ

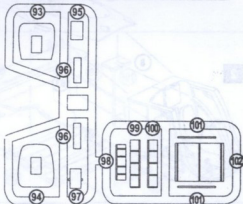
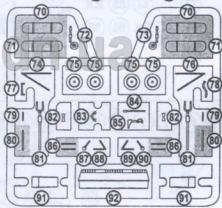
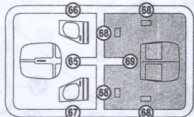

- 1** 5 6 7 9 12 13 94 95

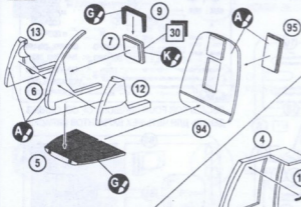

- 2** 3 4 2x 16
77 78 83 85 2x
91 93 2x 96 97
1

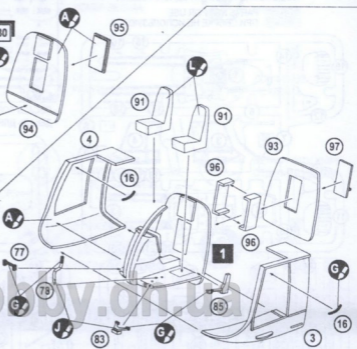

- 3** 1 2 8 10 11 20 27 63 92 2

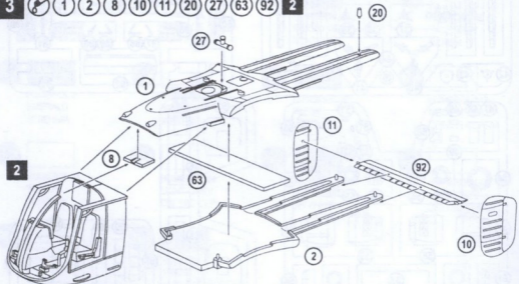

4



47

48

2x 54

2x 55

2x 56

57

60

2x 62

3

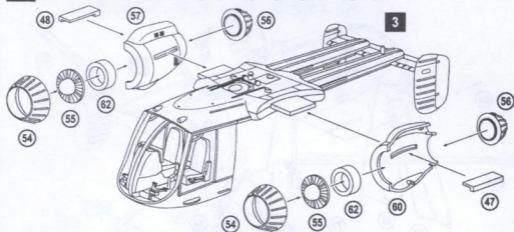

5



2x 49

58

59

2x 81

2x 82

4

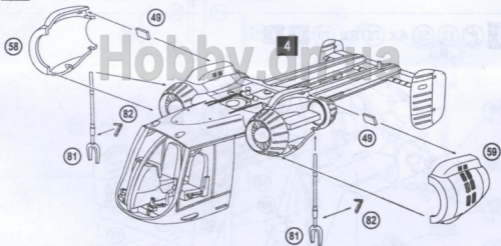

6



98

99

100

2x 101

102

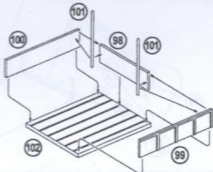

7  72 73 74 76 84 88 89 5

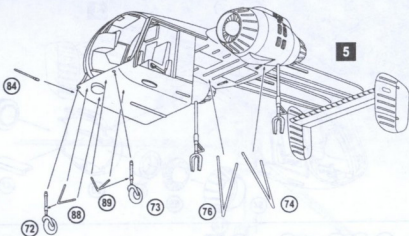

8  17 50 4x 75 2x 79 6 7

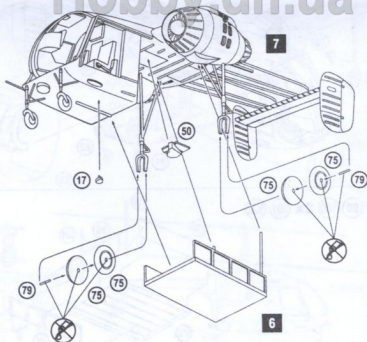

9

 3x 24 3x 25 26 28 29 3x 30 3x 31 32 3x 33 3x 34
 3x 35 36 37 38 39 40 41 42 43 44 45

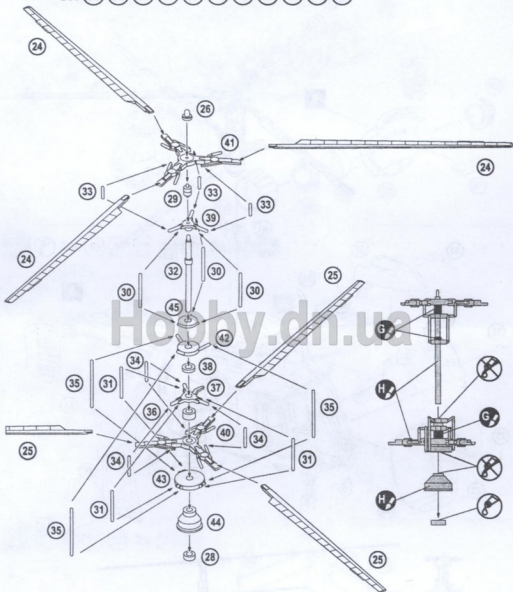

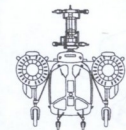
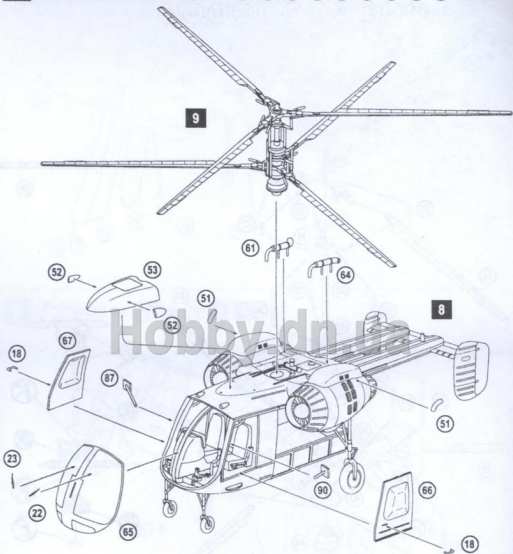

Ka-26, Aeroflot USSR, 70th years / Ка-26, Аэрофлот СССР, 70-е года

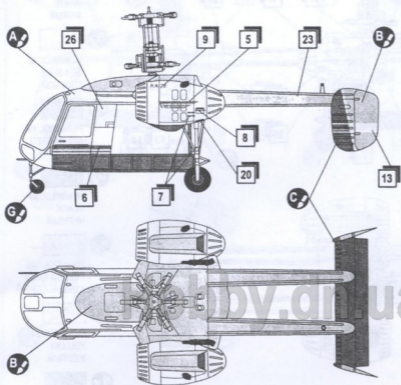



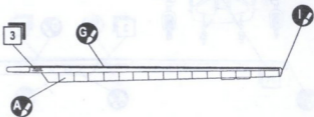
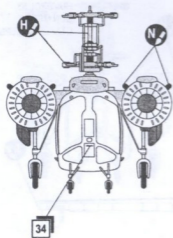

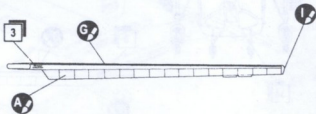
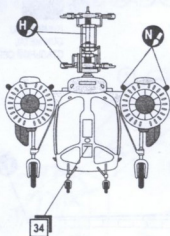
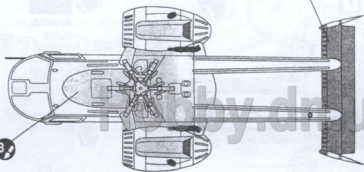
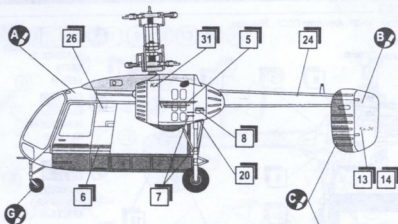

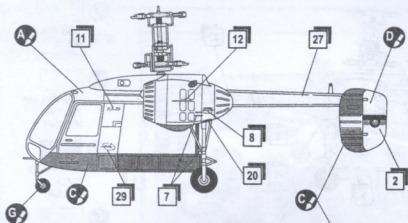

- A**  HUMBROL 22
WHITE
БЕЛЫЙ
- B**  HUMBROL 47
SEA BLUE
ГОЛУБОЙ
- C**  HUMBROL 19
BRIGHT RED
КРАСНЫЙ
- G**  HUMBROL 33
BLACK
ЧЕРНЫЙ
- H**  HUMBROL 145
MEDIUM GREY
СРЕДНЕ СЕРЫЙ
- I**  HUMBROL 24
YELLOW
ЖЕЛТЫЙ
- N**  HUMBROL 53
GUN METAL
СТАЛЬНОЙ СЕРЫЙ





- A**  HUMBROL 22
WHITE
БЕЛЫЙ
- B**  HUMBROL 47
SEA BLUE
ГОЛУБОЙ
- C**  HUMBROL 19
BRIGHT RED
КРАСНЫЙ
- G**  HUMBROL 33
BLACK
ЧЕРНЫЙ
- H**  HUMBROL 145
MEDIUM GREY
СРЕДНЕ СЕРЫЙ
- I**  HUMBROL 24
YELLOW
ЖЕЛТЫЙ
- N**  HUMBROL 53
GUN METAL
СТАЛЬНОЙ СЕРЫЙ



- A**  HUMBROL 22
WHITE
БЕЛЫЙ
- C**  HUMBROL 19
BRIGHT RED
КРАСНЫЙ
- D**  HUMBROL 40
PALE GREY
СЕРЫЙ
- G**  HUMBROL 33
BLACK
ЧЕРНЫЙ
- H**  HUMBROL 145
MEDIUM GREY
СРЕДНЕ СЕРЫЙ
- I**  HUMBROL 24
YELLOW
ЖЕЛТЫЙ
- N**  HUMBROL 53
GUN METAL
СТАЛЬНОЙ СЕРЫЙ

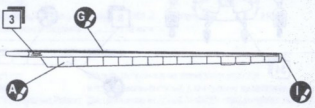
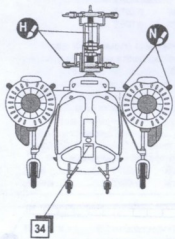
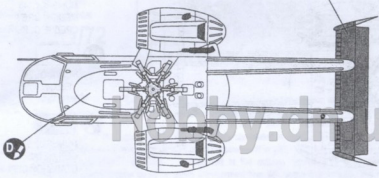

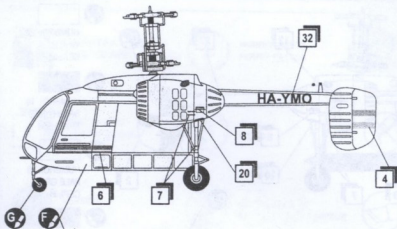

A 
 HUMBROL 22
 WHITE
 БЕЛЫЙ

F 
 HUMBROL 188
 YELLOW
 ЖЕЛТЫЙ

G 
 HUMBROL 33
 BLACK
 ЧЕРНЫЙ

H 
 HUMBROL 145
 MEDIUM GREY
 СРЕДНЕ СЕРЫЙ

I 
 HUMBROL 24
 YELLOW
 ЖЕЛТЫЙ

N 
 HUMBROL 53
 GUN METAL
 СТАЛЬНОЙ СЕРЫЙ

