

AZmodel
Plastic kits

SUPERMARINE SPITFIRE MK 22,24 SEAFIRE MK 46

Plastic model

scale :1/72

The Supermarine Spitfire is a British single-seat fighter aircraft which was used by the Royal Air Force and many other Allied countries throughout the Second World War. The Spitfire continued to be used as a front line fighter and in secondary roles into the 1950s. It was produced in greater numbers than any other British aircraft and was the only British fighter in production throughout the war. The Rolls-Royce Griffon engine was designed in answer to Royal Naval specifications which required an engine capable of generating good power at low altitudes. A total of 272 Mk 22s and 81 Mk 24s were built. Mk 46 is navalised versions of Griffon Spitfires.

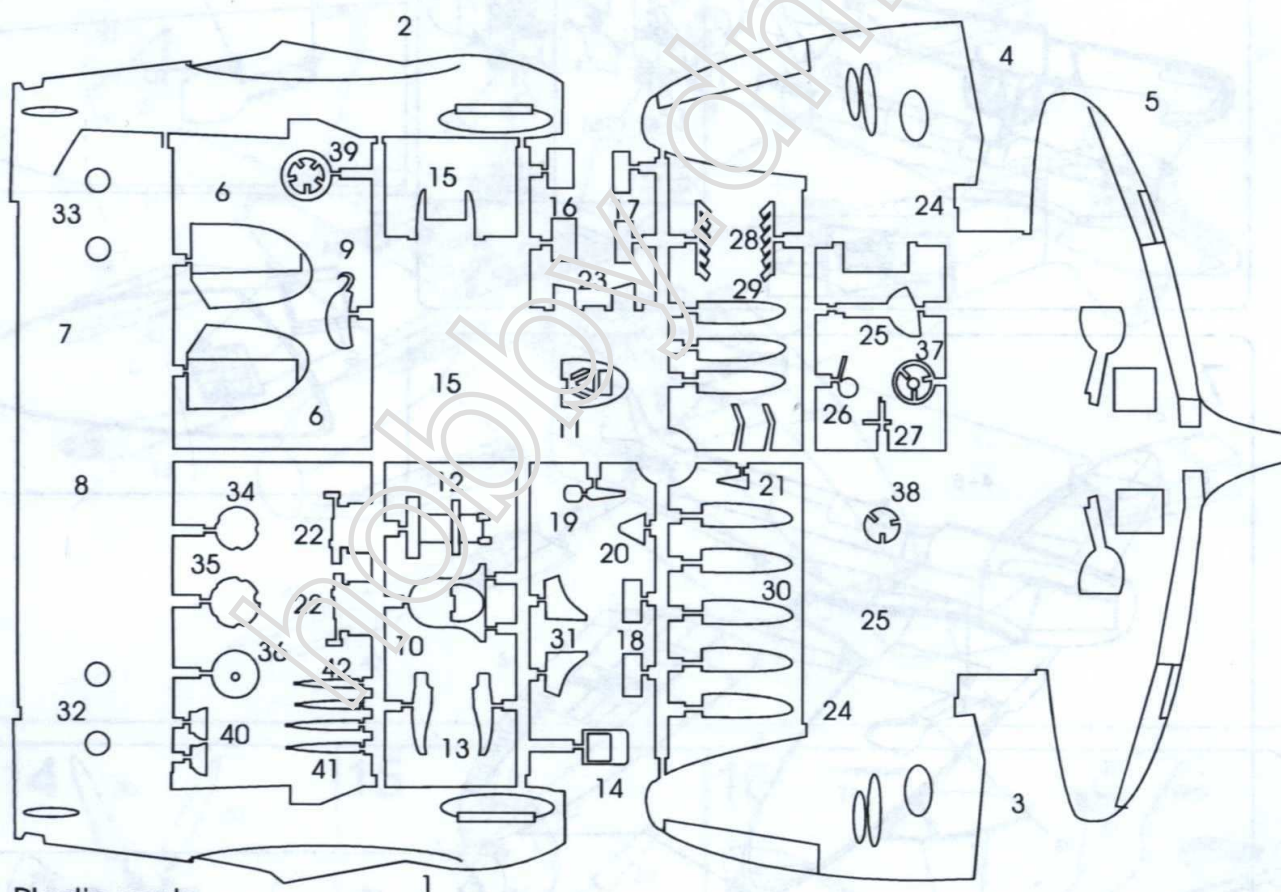

Plastic parts

Transparent parts



Photo-Etched parts



colour name		colour name	
Black	A	Dark Grey	E
White	B	Desert Yellow	F
Interior Green	C	Aluminium	G
Light Grey	D	Brown	H

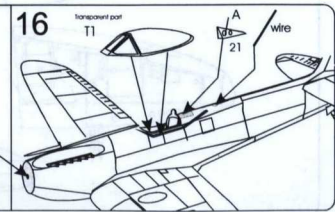
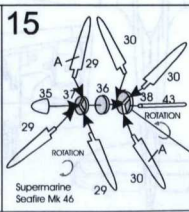
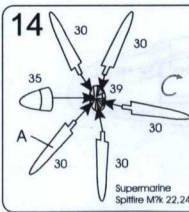
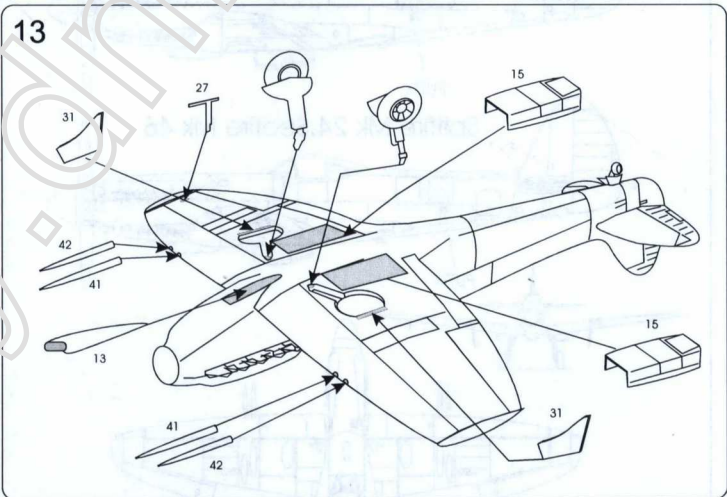
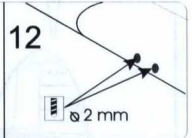
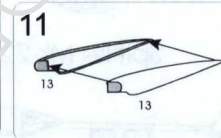
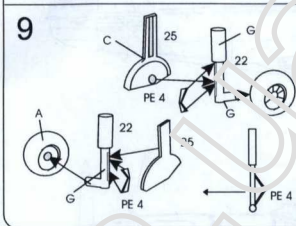
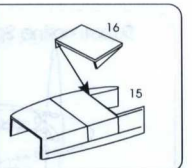
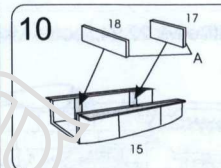
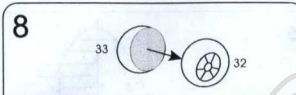
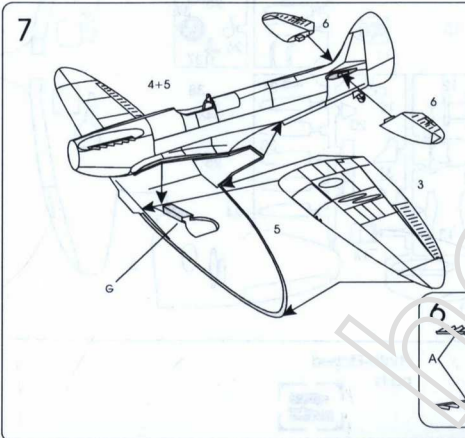
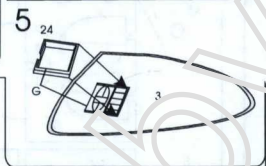
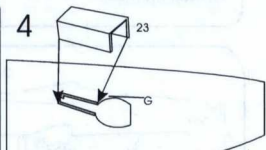
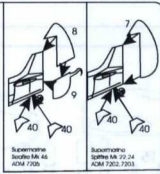
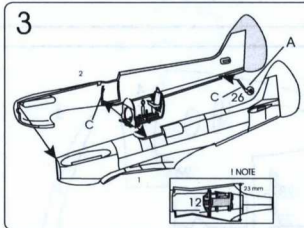
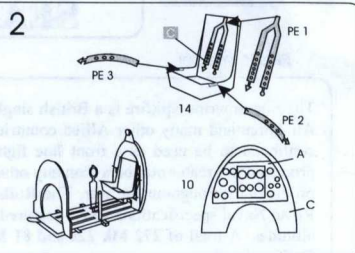
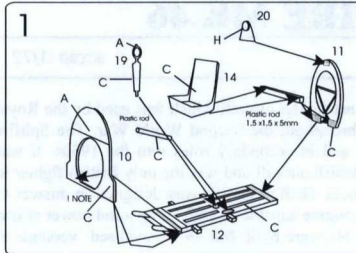

Supermarine Spitfire Mk 22,24,Seafire Mk46

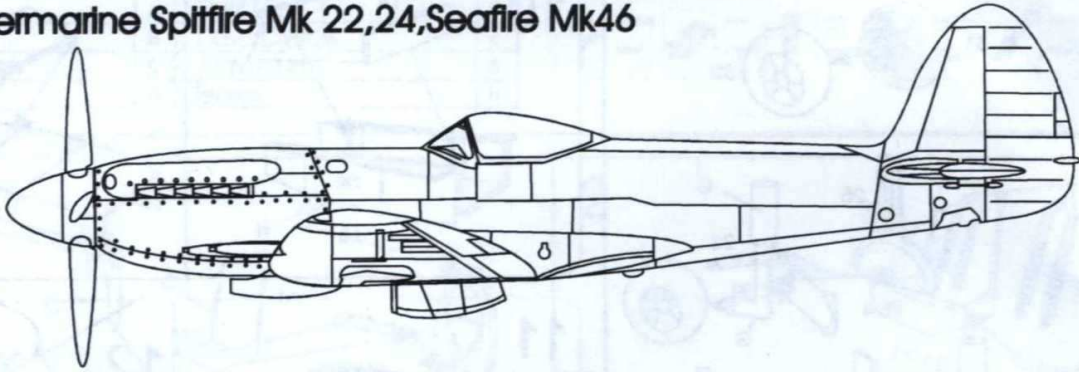

Spitfire Mk 22



PUTTY

Spitfire Mk 24, Seafire Mk 46



PUTTY

