

UNIVERSAL CARRIER I Mk I with Boys AT rifle















Cat. no. 72026

Scale 1/72



Project, design & artwork: Jarosław Leoniec
Research: Jarosław Leoniec & IBG crew

-  Element złożony we wcześniejszym etapie
Element assembled in previous step
-  Element po złożeniu w aktualnym etapie
Element after assembly in actual step
-  Wersja do wyboru
Version to choose
-  Kalkomania
Decal
-  Kolor farby
Paint colour
-  Część nie do użycia
Part not for use

	Gunze Mr.Color	Model Master Acrylic	Humbrol	Vallejo MC
black	 C002	4695	21	861
wood	 C043	4673	110	846
gunmetal	 C104	4681	53	863
green	 C136	4807	102	894
leather	 C019	4674	62	843
bronze green	 C017	~4726	75	897
panzer gray	 C040	4795	67	995

Przed montażem przeczytać instrukcję. Przestrzegać kolejności montażu podanego w instrukcji! Klej i farby nie wchodzą w skład zestawu.

Uwaga! Zdecydowanie sugerujemy użycie bardzo rzadkiego kleju - Tamiya Extra Thin Cement jest najlepszym wyborem. Montaż gąsienicy należy przeprowadzić dość szybko, bo sklejona gąsienica zachowuje miękkość przez kilkanaście minut i można ją wtedy wyginać i dopasowywać.

Please read instruction before assembly. Obey sequence of assembly like in instruction. Glue and paints not included.
Attention! We strongly suggest using of very thin glue - Tamiya Extra Thin Cement will be the best choice. Assembly of track please make in short period of time, because assembled track is still soft and can be fitted and bended.

Ramka J / Frame J

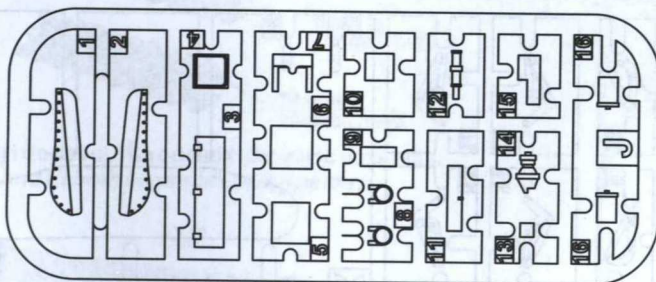

Ramka B / Frame B

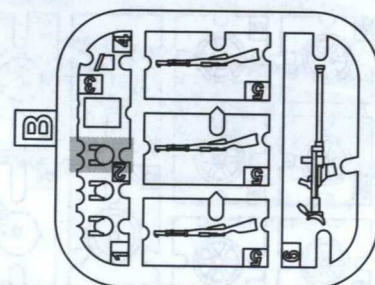

International Business Group
ul. Benedykta Hertza 2
04-603 Warszawa
Poland

tel +48 22 8159150
fax +48 22 8159151
ibgsc@ibg.com.pl
www.ibg.com.pl

Ramka bez oznaczenia literowego / No letter frame

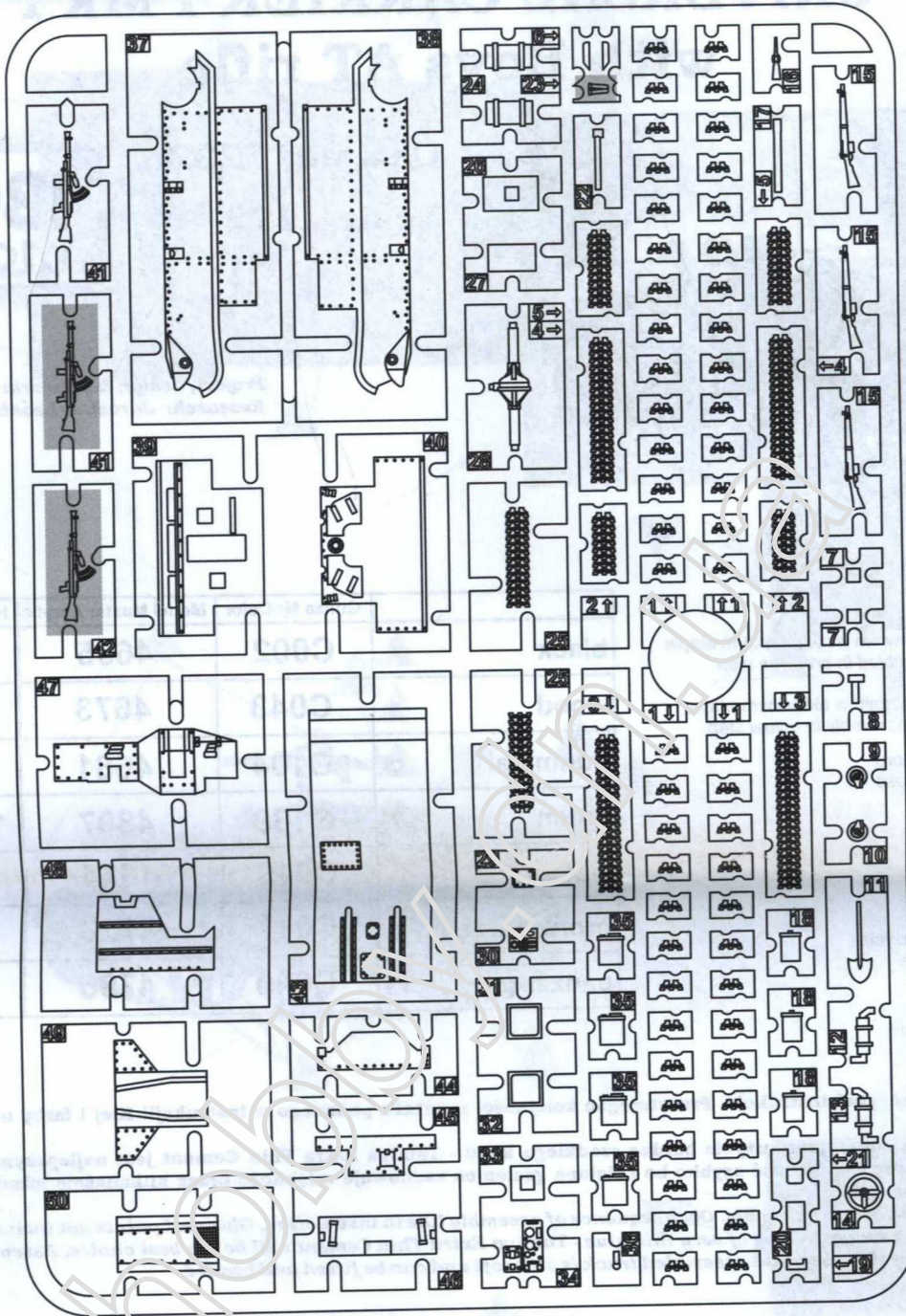

Ramka X / Frame X

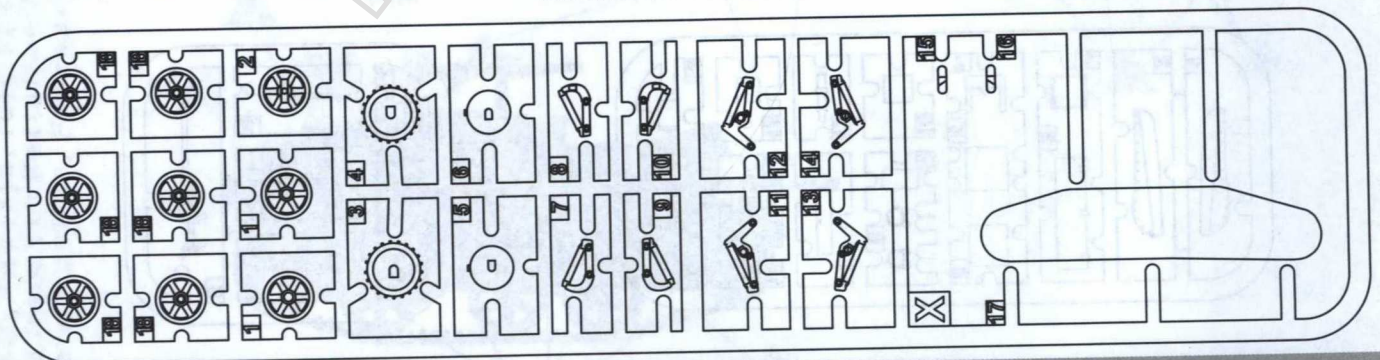

International Business Group
 ul. Benedykta Hertza 2
 04-603 Warszawa
 Poland

tel +48 22 8159150
 fax +48 22 8159151
 ibgsc@ibg.com.pl
 www.ibg.com.pl

ETAP 1 Montaż gaśienicy
STEP 1 Track assembly

Uwaga! Zdecydowanie sugerujemy użycie bardzo rzadkiego kleju - Tamiya Extra Thin Cement jest najlepszym wyborem. Należy zmontować dwie gaśienice.
Attention! We strongly suggest using of very thin glue - Tamiya Extra Thin Cement will be the best choice. Two tracks have to be assembled.

- I** Montuj gaśenicę na twardej, płaskiej powierzchni. Posmaruj odrobiną kleju i zsuń do złączenia używając dwóch igieł.
Assembly track on hard, flat surface. Add some glue and slide together using two needles.



- II** Dociśnij do powierzchni dla wyrównania.
Press to flat surface to align.

dociśnij/press



- III** Analogicznie dodaj kolejne ogniwa.
Analogically add two track links.



- IV** Dociśnij do powierzchni dla wyrównania.
Press to flat surface to align.

dociśnij/press



- V** Złóż dwa odcinki - z 10 ogniw i z 11 ogniw.
Assembly two segments - 10 track links and 11 track links.

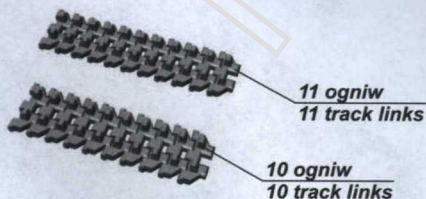

- VI** Zegnij i dopasuj oba odcinki używając wzornika.
Bend and fit both segments using pattern.

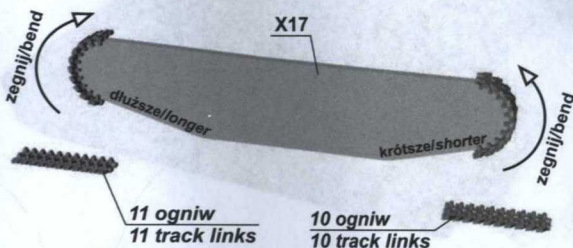

- VII** Dopasuj i sklej pierwszą część gaśienicy używając wzornika.
Fit and glue first part of track using pattern.

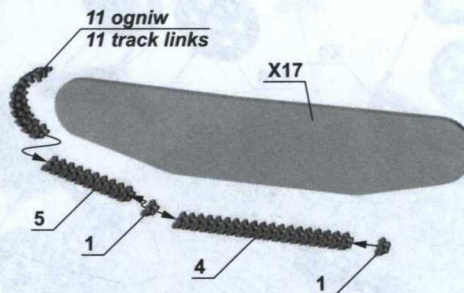

- VIII** Dopasuj i sklej drugą część gaśienicy używając wzornika.
Fit and glue second part of track using pattern.

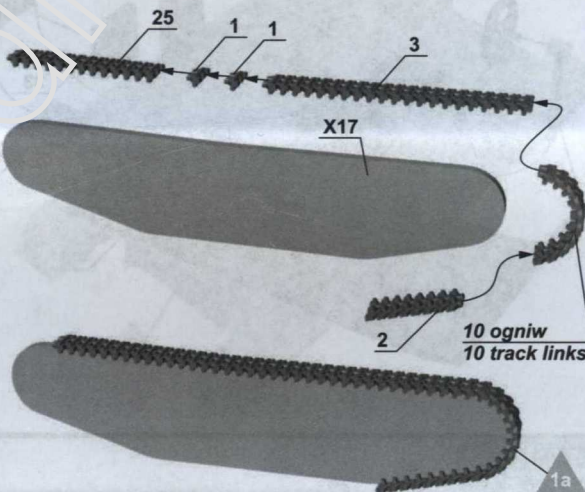

- IX** Sprawdź dopasowanie obu części używając wzornika. Nie sklejaj ich razem!
Check fitting both parts of track using pattern. Don't glue them together!

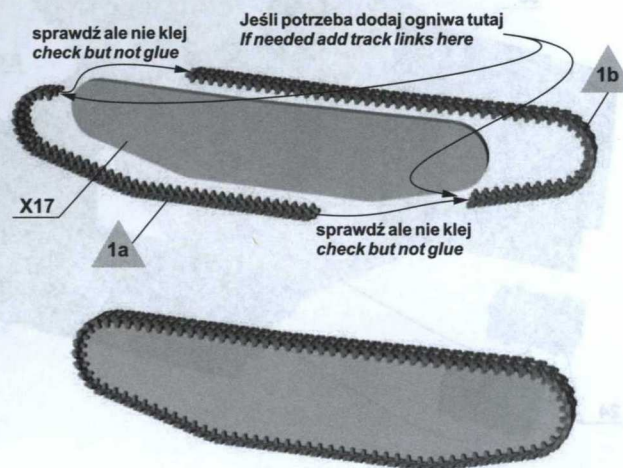

**ETAP 2
STEP 2**

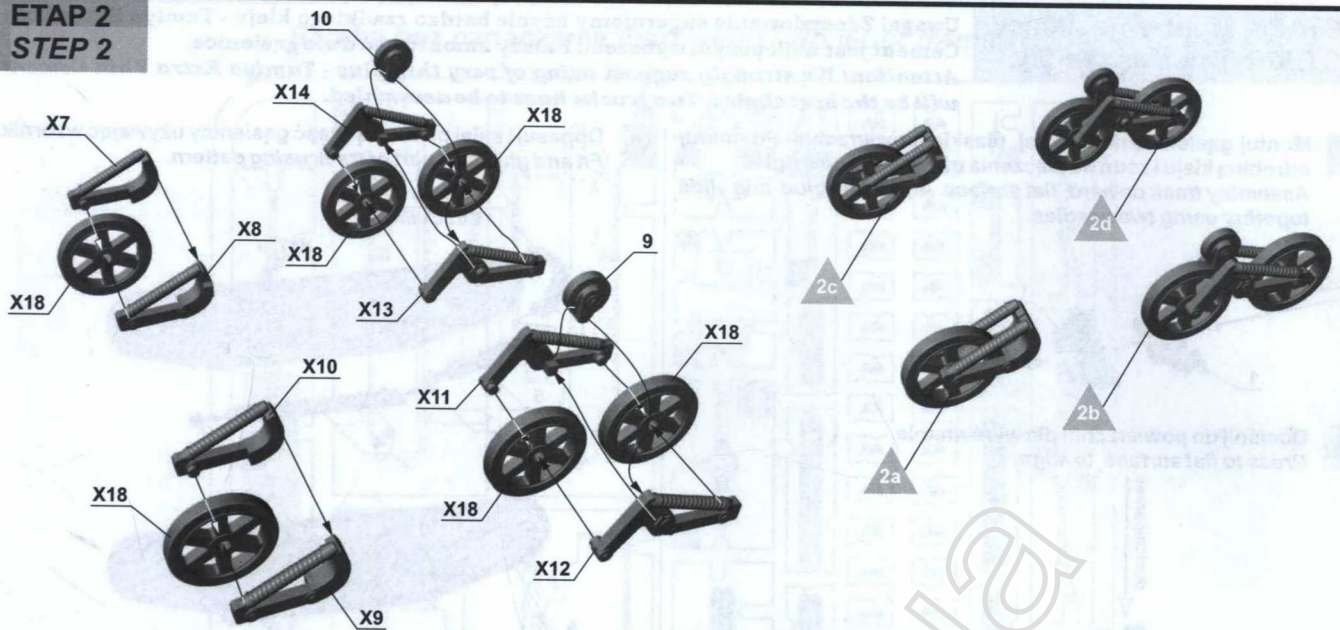

**ETAP 3
STEP 3**

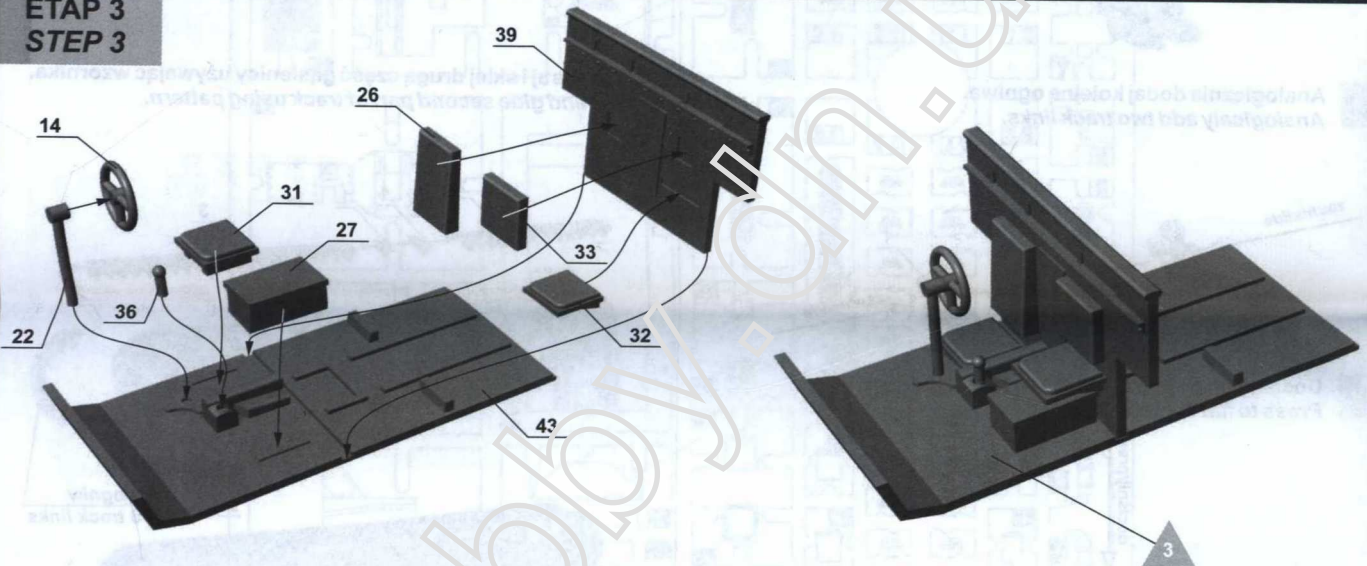

**ETAP 4
STEP 4**

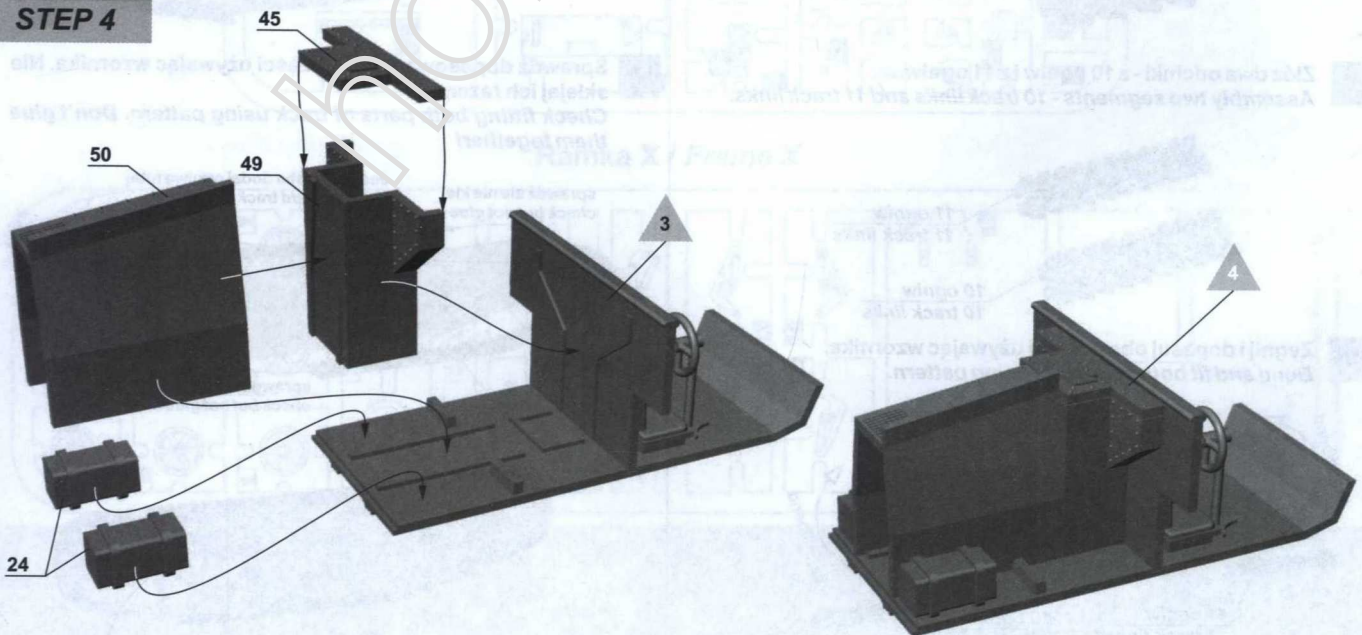

**ETAP 5
STEP 5**

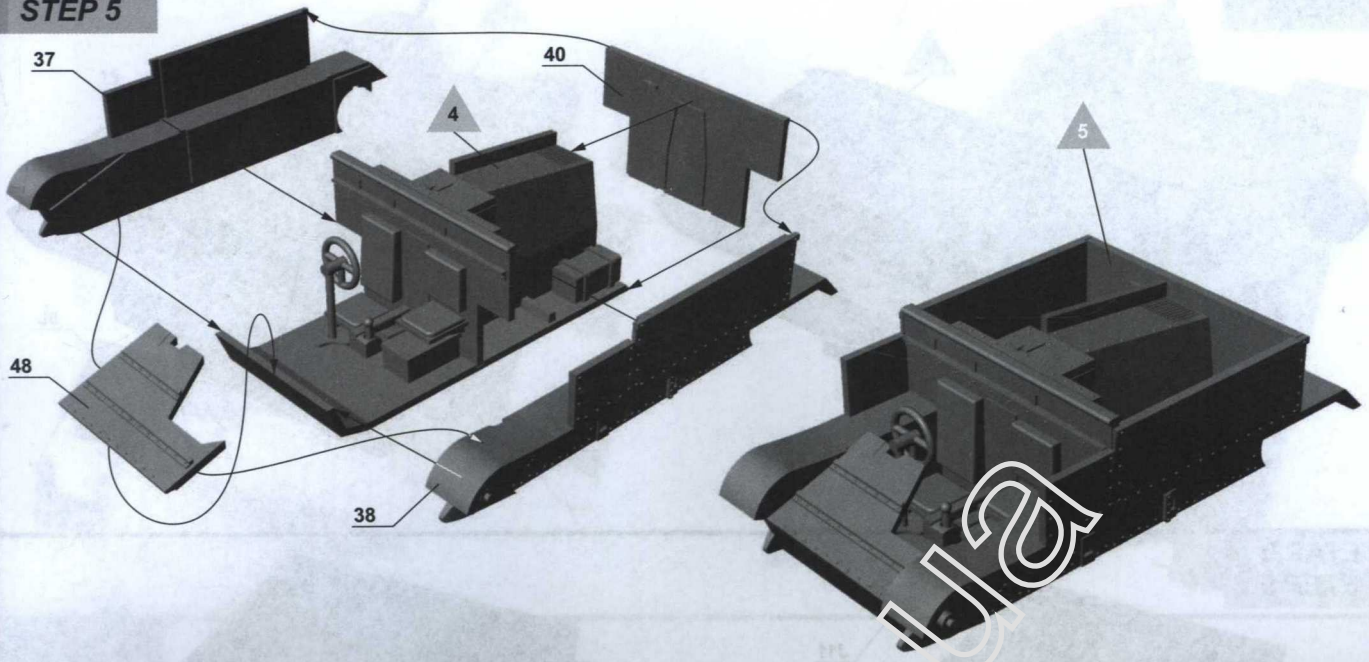

**ETAP 6
STEP 6**

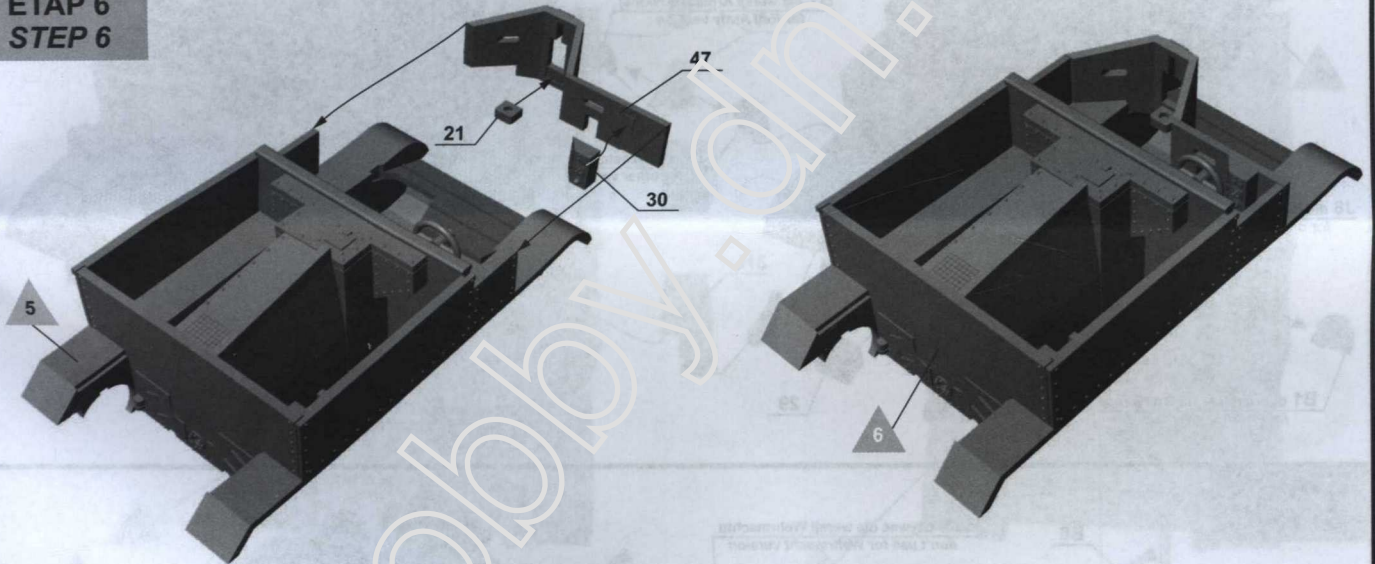

**ETAP 7
STEP 7**

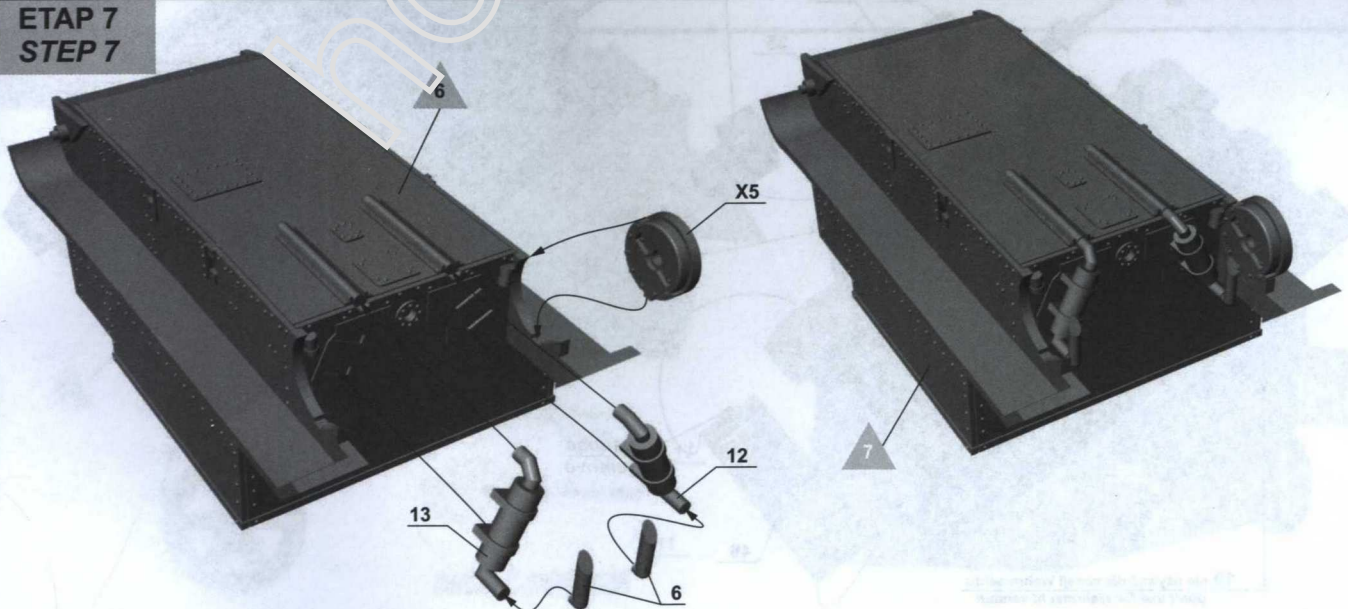

**ETAP 8
STEP 8**

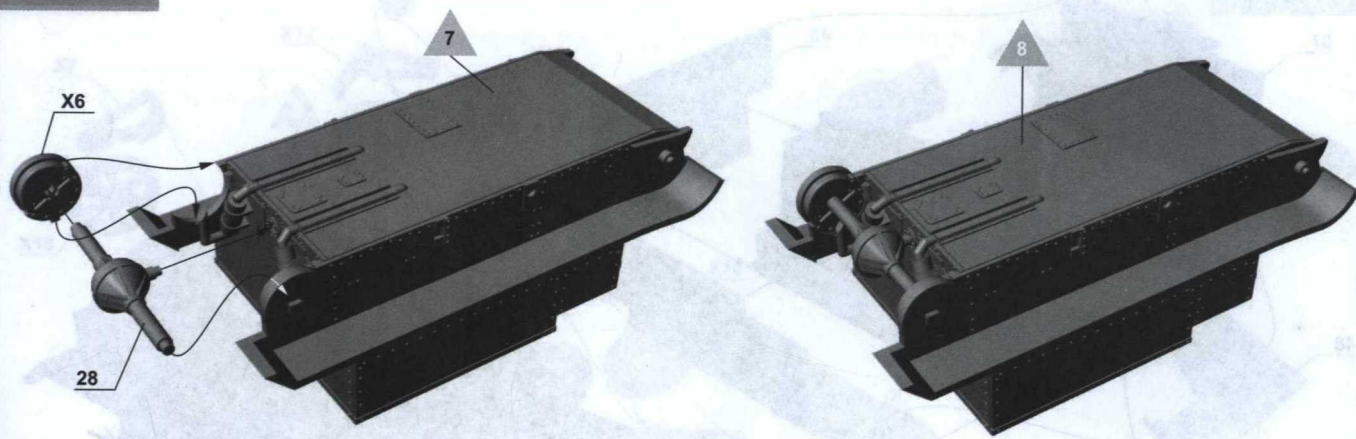

**ETAP 9
STEP 9**

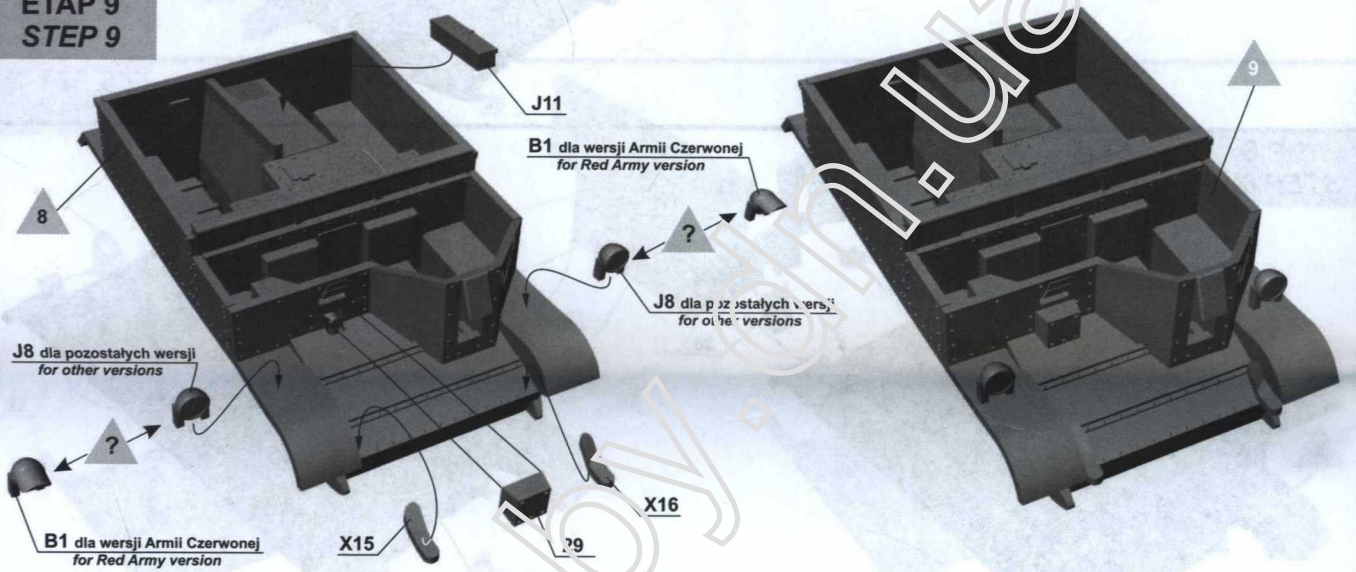

**ETAP 10
STEP 10**

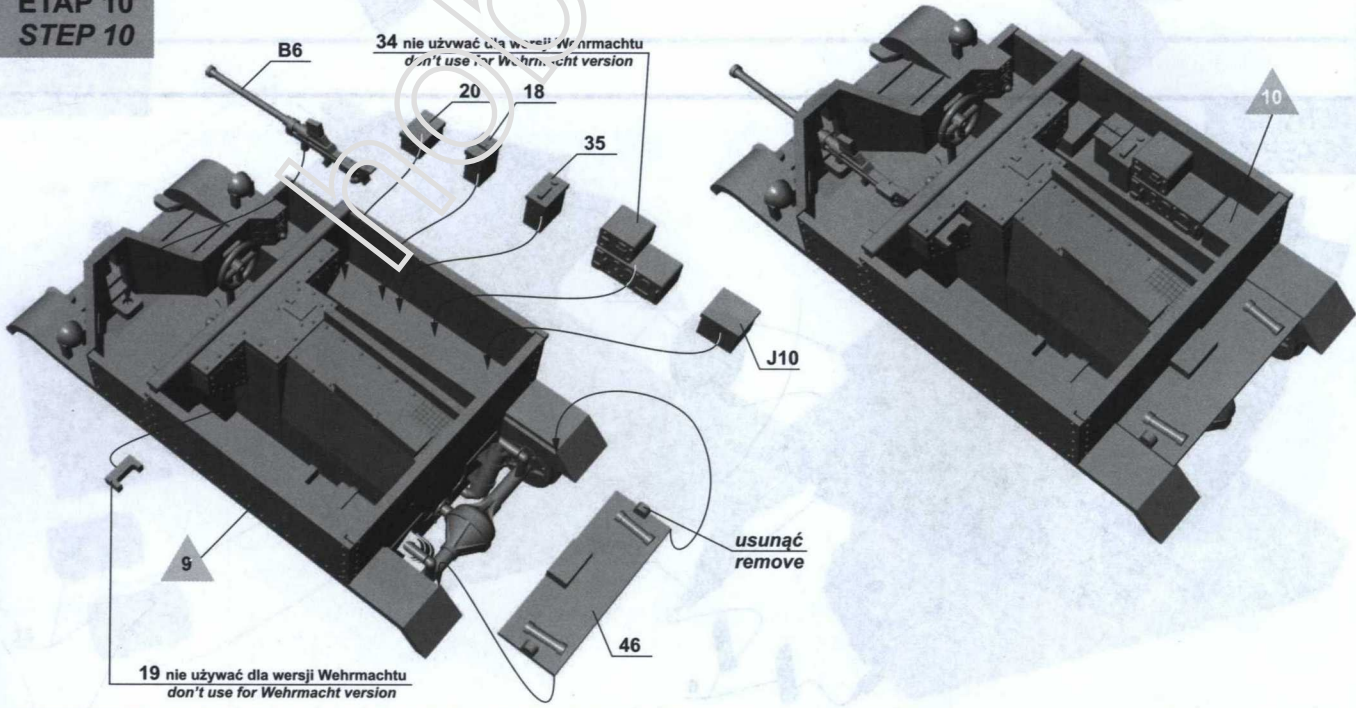

**ETAP 11
STEP 11**

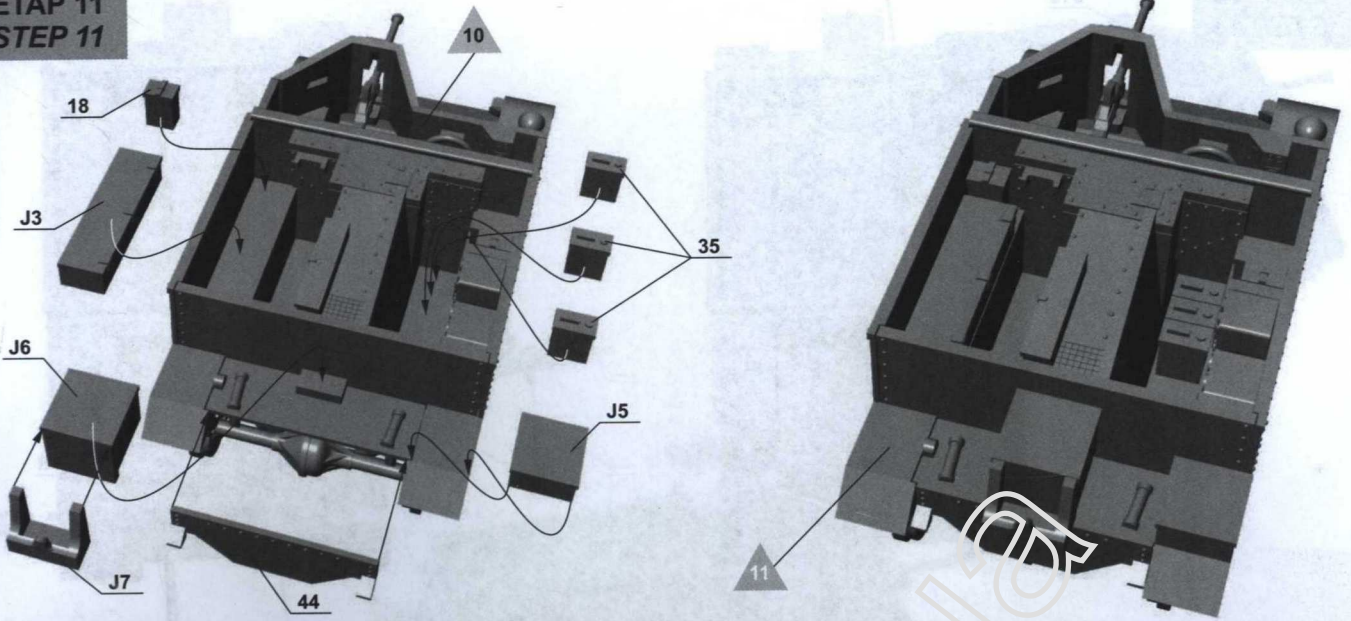

**ETAP 12
STEP 12**

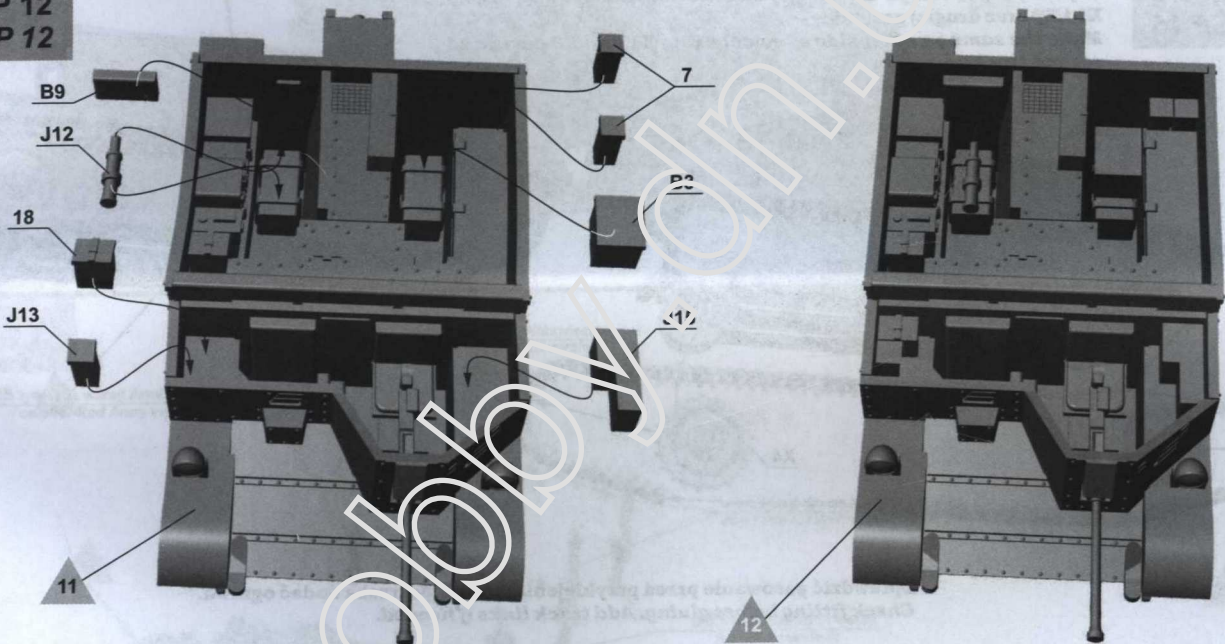

**ETAP 13
STEP 13**

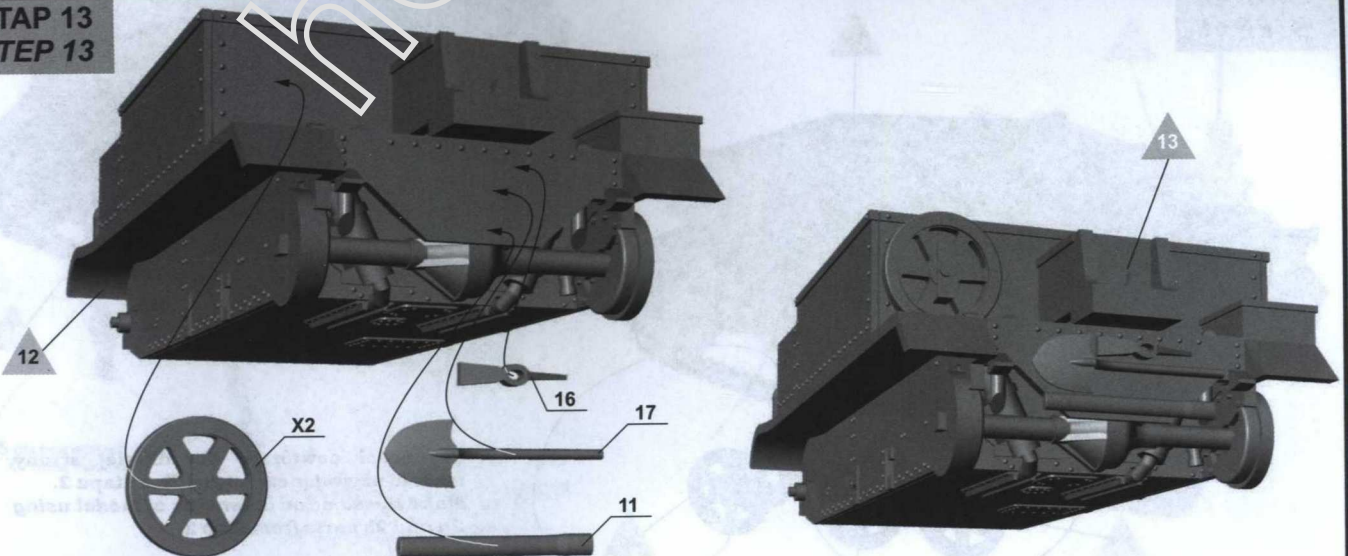

**ETAP 14
STEP 14**

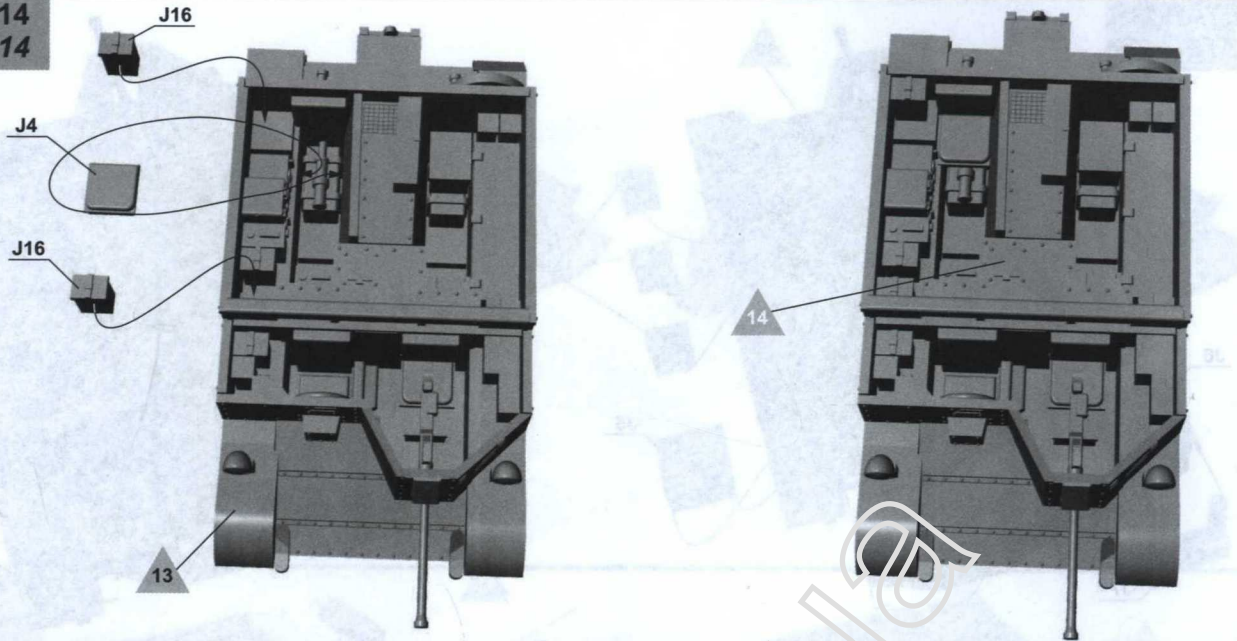

**ETAP 15
STEP 15**

Czynności powtórzyć dla drugiej strony modelu używając części X1 i X3 oraz drugiej gąsienicy.
Make the same on other side of model using X1 and X3 parts and second track.

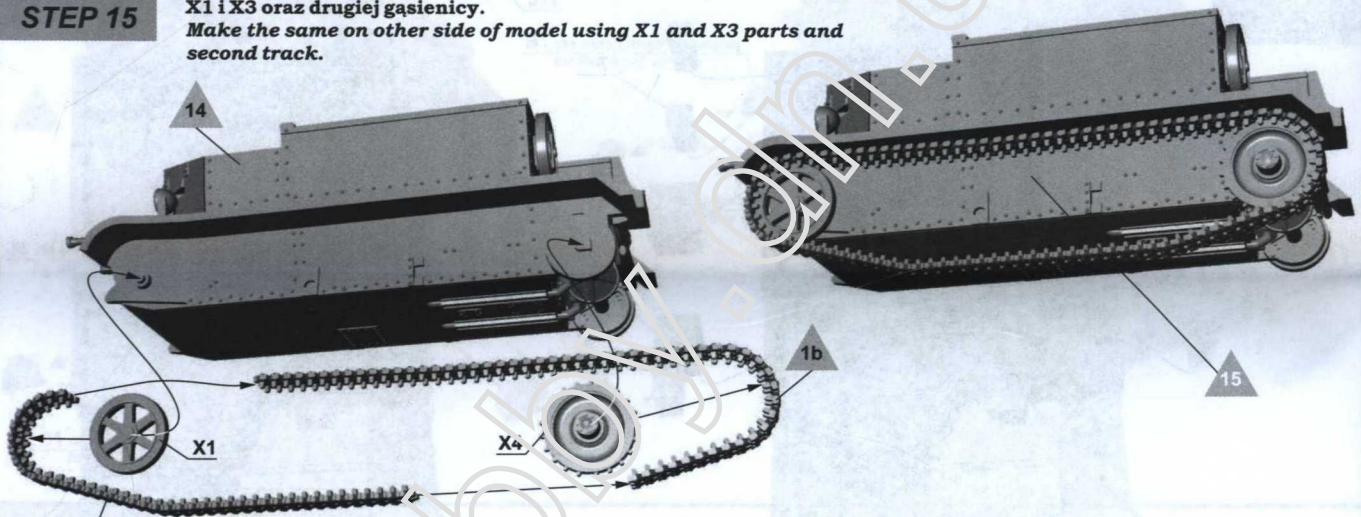

Sprawdzić pasowanie przed przyklejeniem. Jeśli potrzeba dodać ogniwa.
Check fitting before gluing. Add track links if needed.

**ETAP 16
STEP 16**

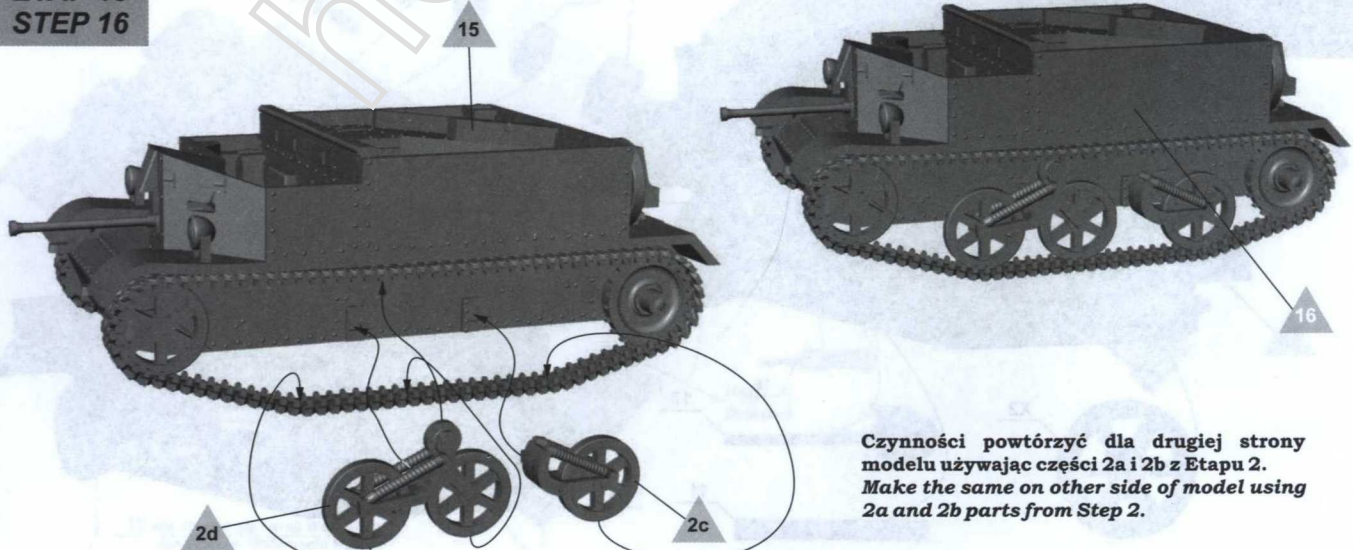

Czynności powtórzyć dla drugiej strony modelu używając części 2a i 2b z Etapu 2.
Make the same on other side of model using 2a and 2b parts from Step 2.

ETAP 17
STEP 17

41 nie używać dla wersji Wehrmachtu
don't use for Wehrmacht version

8 nie używać dla wersji Wehrmachtu
don't use for Wehrmacht version

B4 tylko dla wersji Armii Czerwonej
only for Red Army version

antena - wykonać z cienkiego drutu
aerial - make from thin wire

J14 tylko dla wersji Armii Czerwonej
only for Red Army version

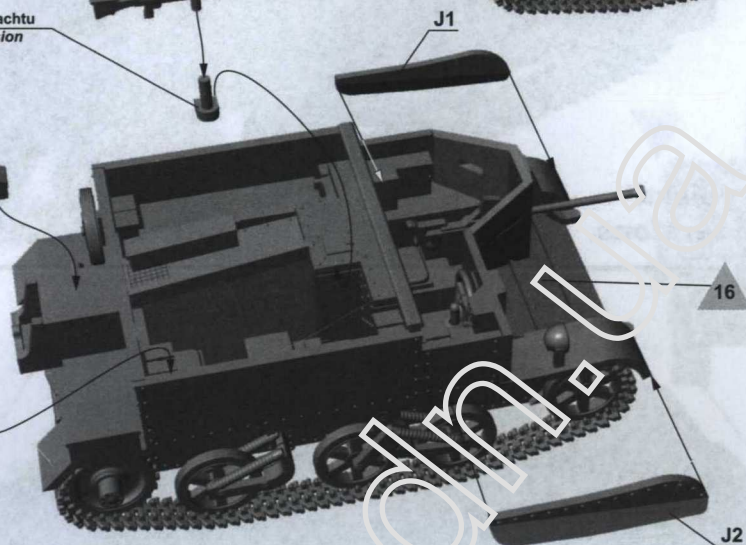
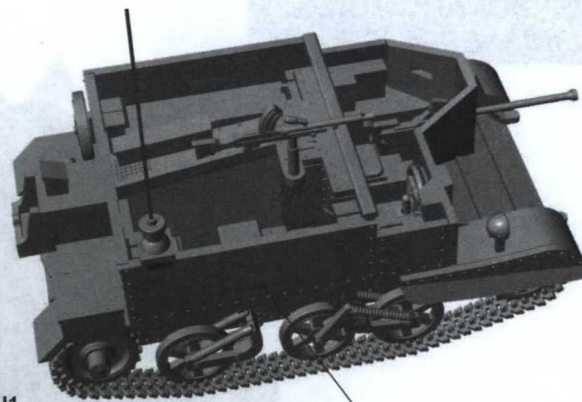

ETAP 18
STEP 18

nie używać dla wersji Wehrmachtu
don't use for Wehrmacht version

B5 tylko dla wersji Armii Czerwonej
only for Red Army version

nie używać dla wersji Wehrmachtu
don't use for Wehrmacht version

B5 dla pozostałych wersji
for other versions

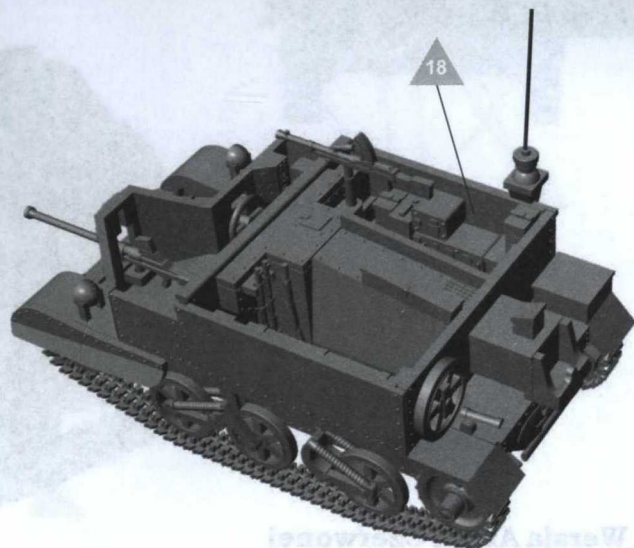
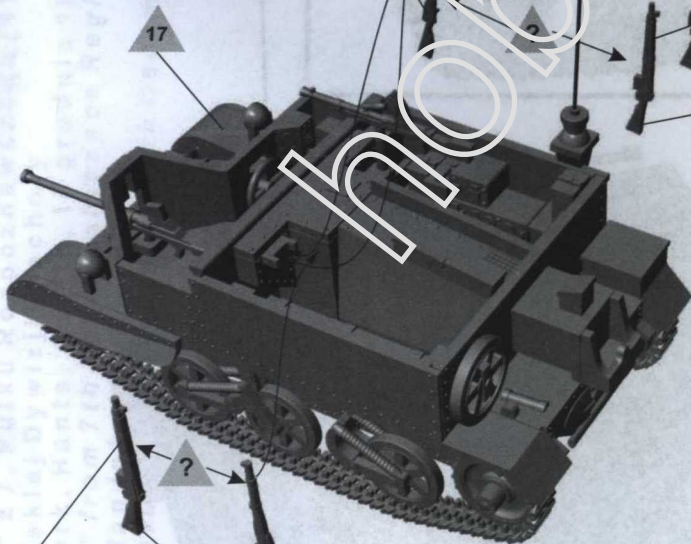

B5 dla pozostałych wersji
for other versions

B5 tylko dla wersji Armii Czerwonej
only for Red Army version

nie używać dla wersji Wehrmachtu
don't use for Wehrmacht version

WYKONANY MODEL
FINISHED MODEL

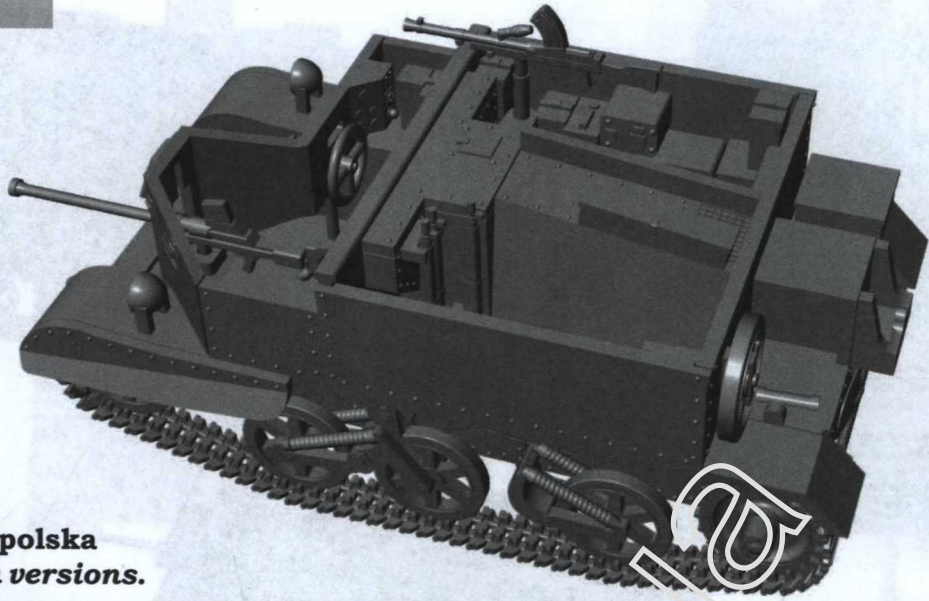

Wersja brytyjska i polska
British and polish versions.

WYKONANY MODEL
FINISHED MODEL

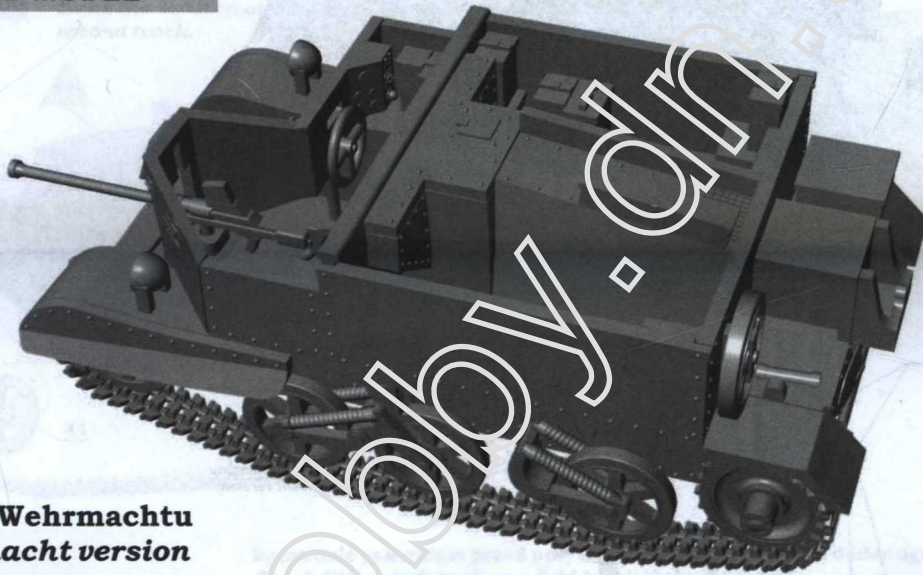

Wersja Wehrmachtu
Wehrmacht version

WYKONANY MODEL
FINISHED MODEL

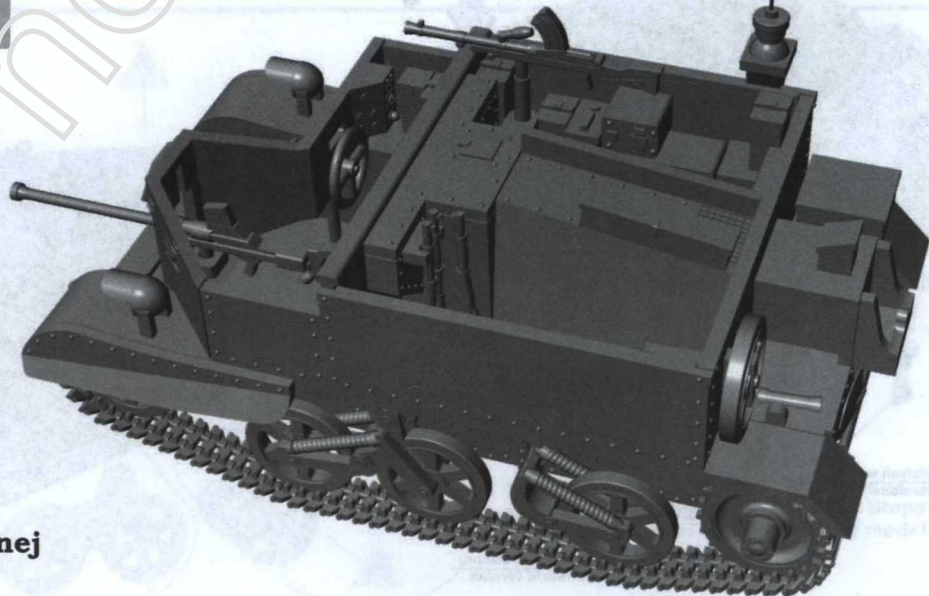

Wersja Armii Czerwonej
Red Army version

**MALOWANIE I KALKOMANIE
COLOURS AND DECALS**

**"Montreal" z 7. Pułku Rozpoznawczego (17. Duke of York's Royal Canadian Hussars)
3. Kanadyjskiej Dywizji Piechoty
Preston Park, Hants, Anglia, 19 grudnia 1942
"Montreal" from 7th Reconnaissance Regiment (17th Duke of York's Royal Canadian Hussars)
3rd Canadian Infantry Division
Preston Park, Hants, England, 19th December 1942**

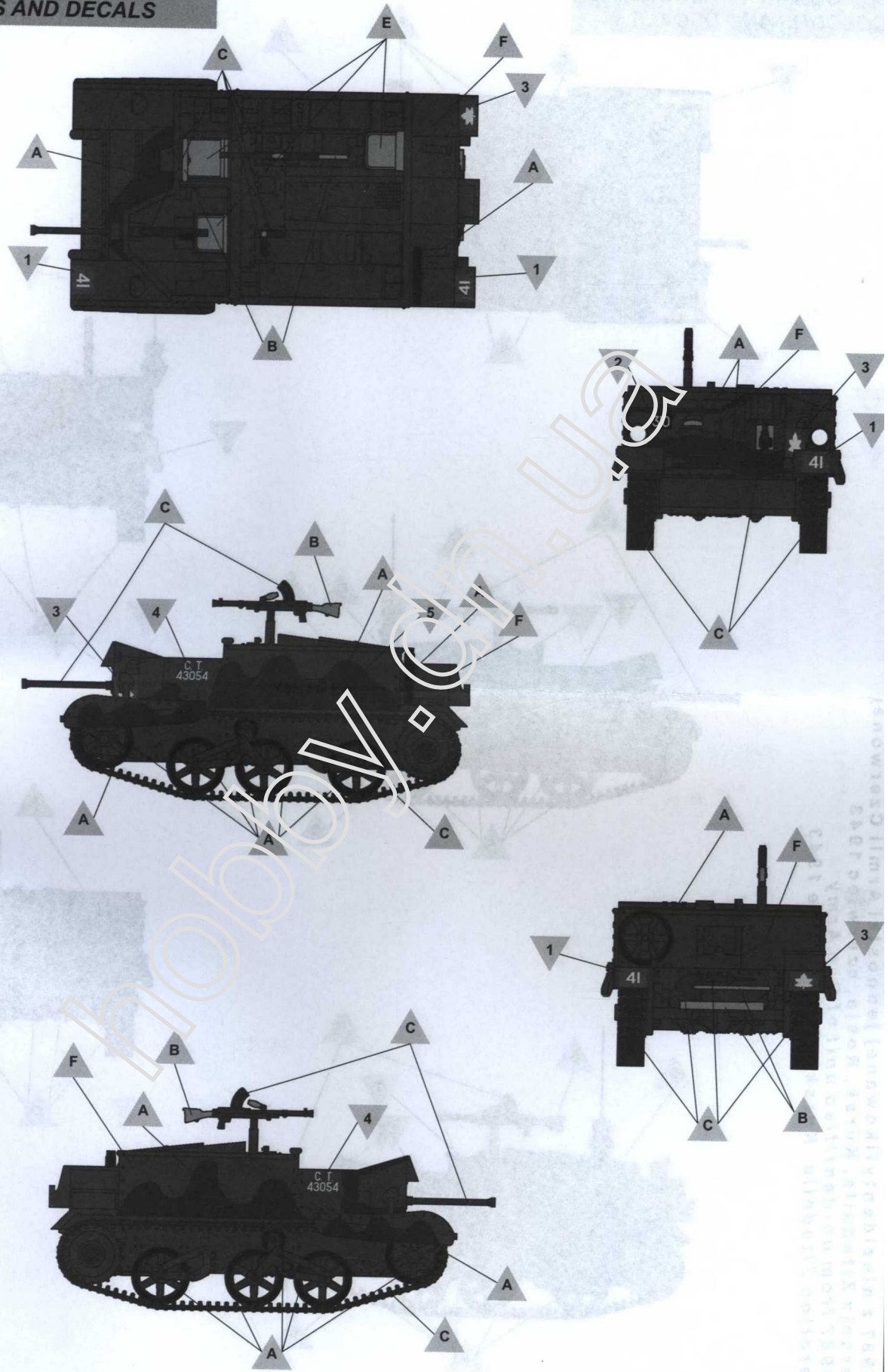

**MALOWANIE I KALKOMANIE
COLOURS AND DECALS**

T78987 z niezidentyfikowanej jednostki Armii Czerwonej
 Operacja Zitadelle, Kursk, Rosja, czerwiec 1943
 T78987 from unidentified unit of Red Army
 Operation Zitadelle, Kursk, Russia, June 1943

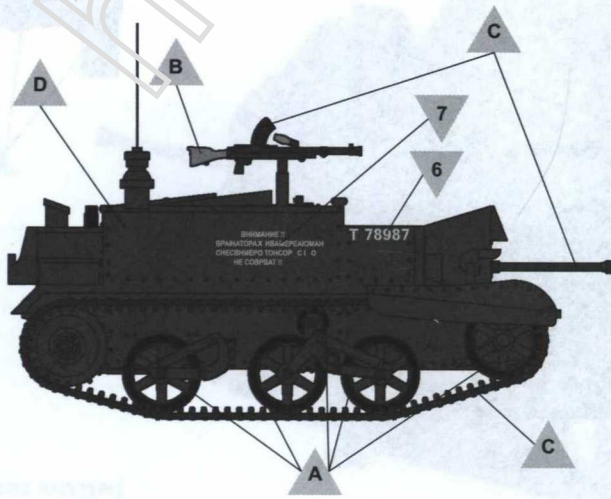
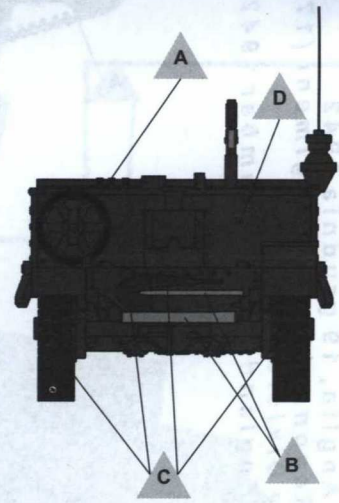
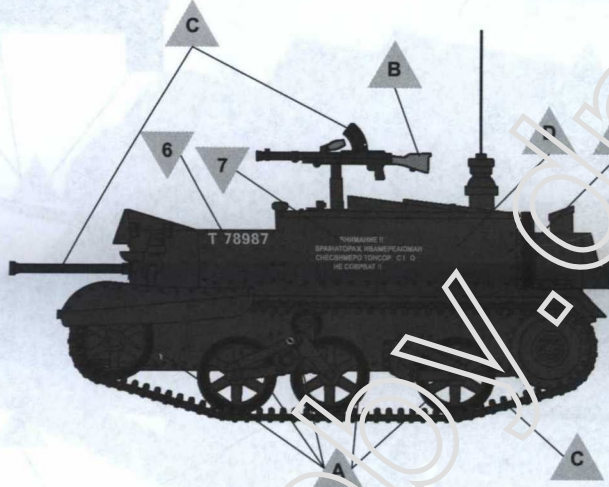
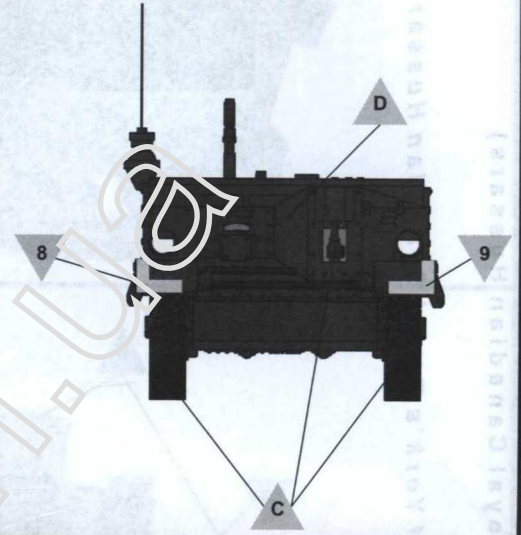
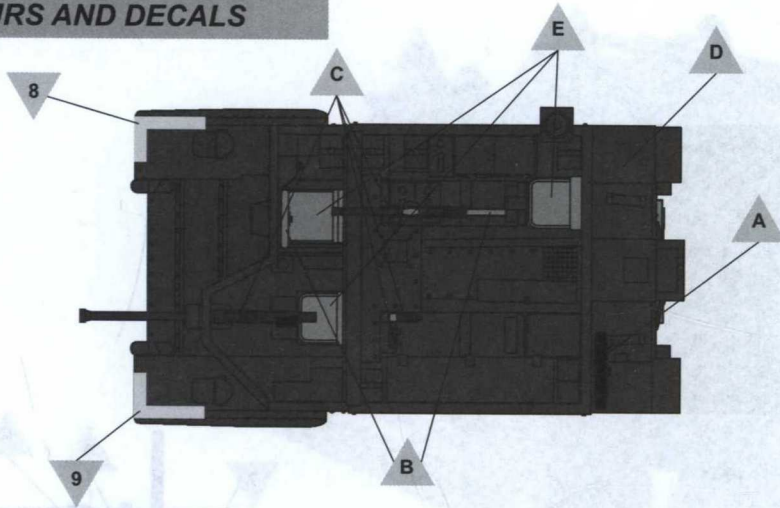

MALOWANIE I KALKOMANIE
COLOURS AND DECALS

T8873 ze szwadronu dowodzenia 10. Pułku Strzelców Konnych 1. Dywizji Pancерnej
Anglia, 1944
T8873 from headquarters company of 10th Polish Mounted Rifle Regiment 1st Polish Armoured Division
England, 1944

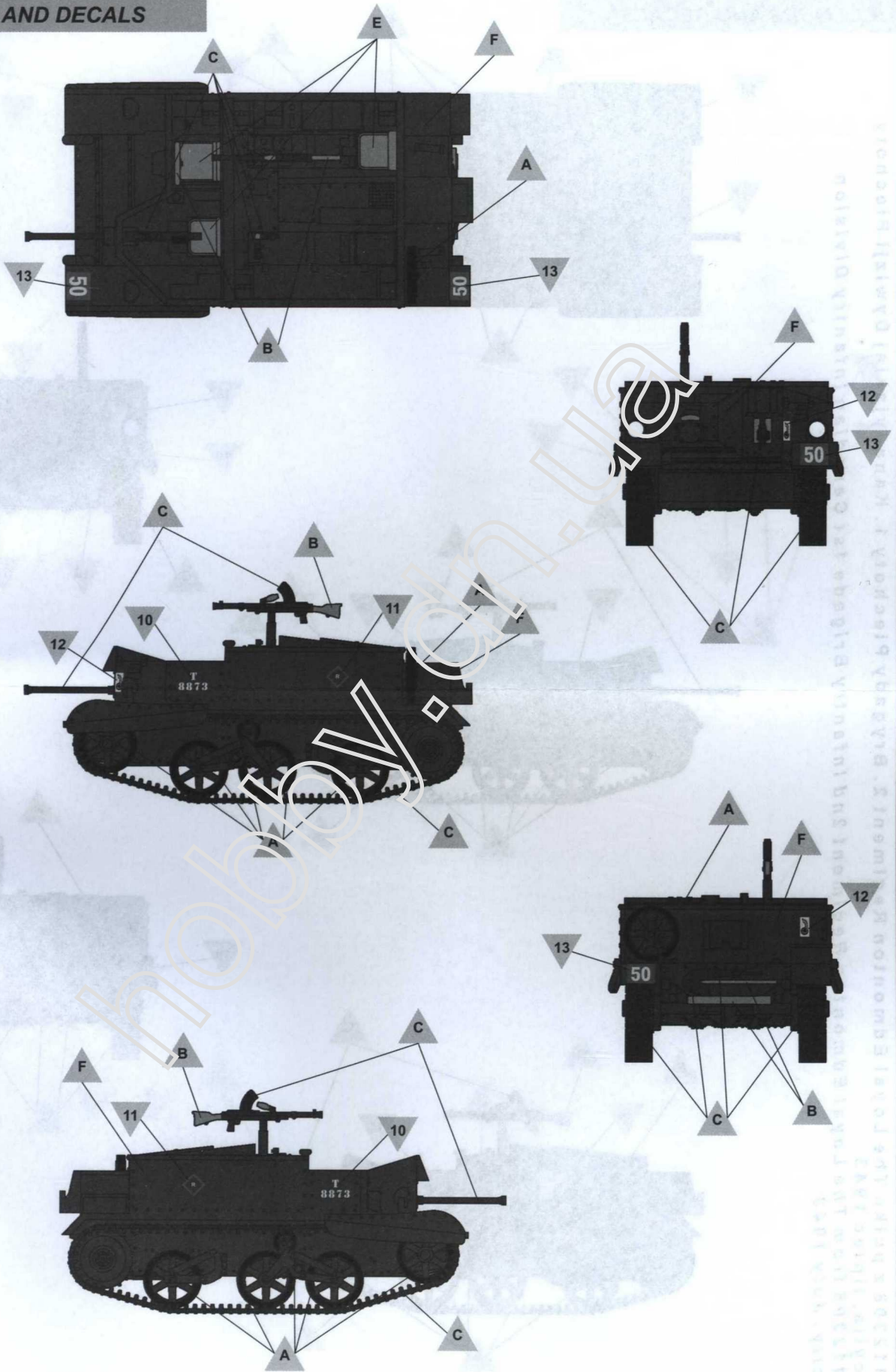

**MALOWANIE I KALKOMANIE
COLOURS AND DECALS**

Ct112308 z pułku The Loyal Edmonton Regiment 2. Brygady Piechoty 1. Kanadyjskiej Dywizji Piechoty
Sycylia, lipiec 1943
Ct112308 from The Loyal Edmonton Regiment 2nd Infantry Brigade 1st Canadian Infantry Division
Sicily, July 1943

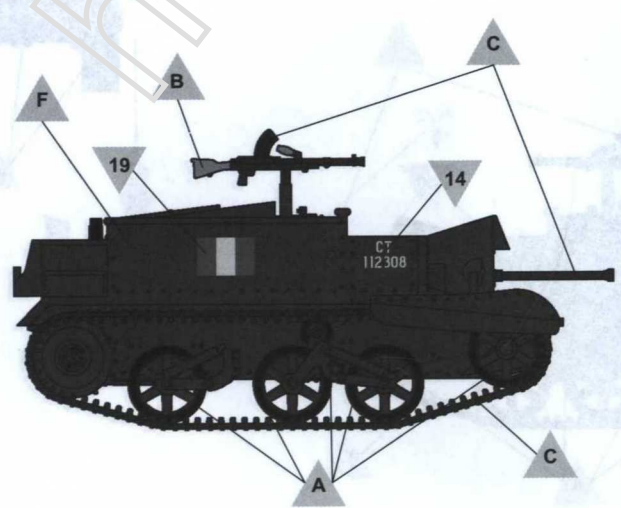
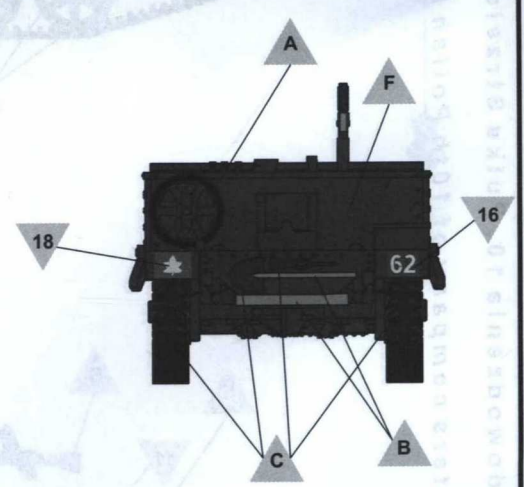
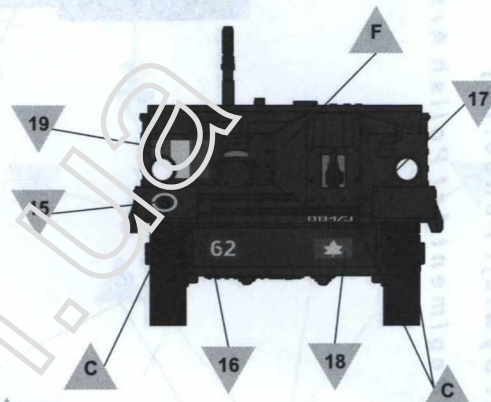
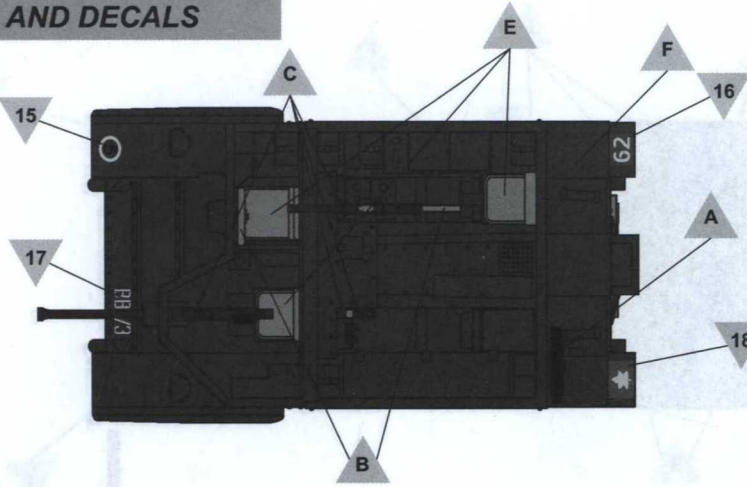

**MALOWANIE I KALKOMANIE
COLOURS AND DECALS**

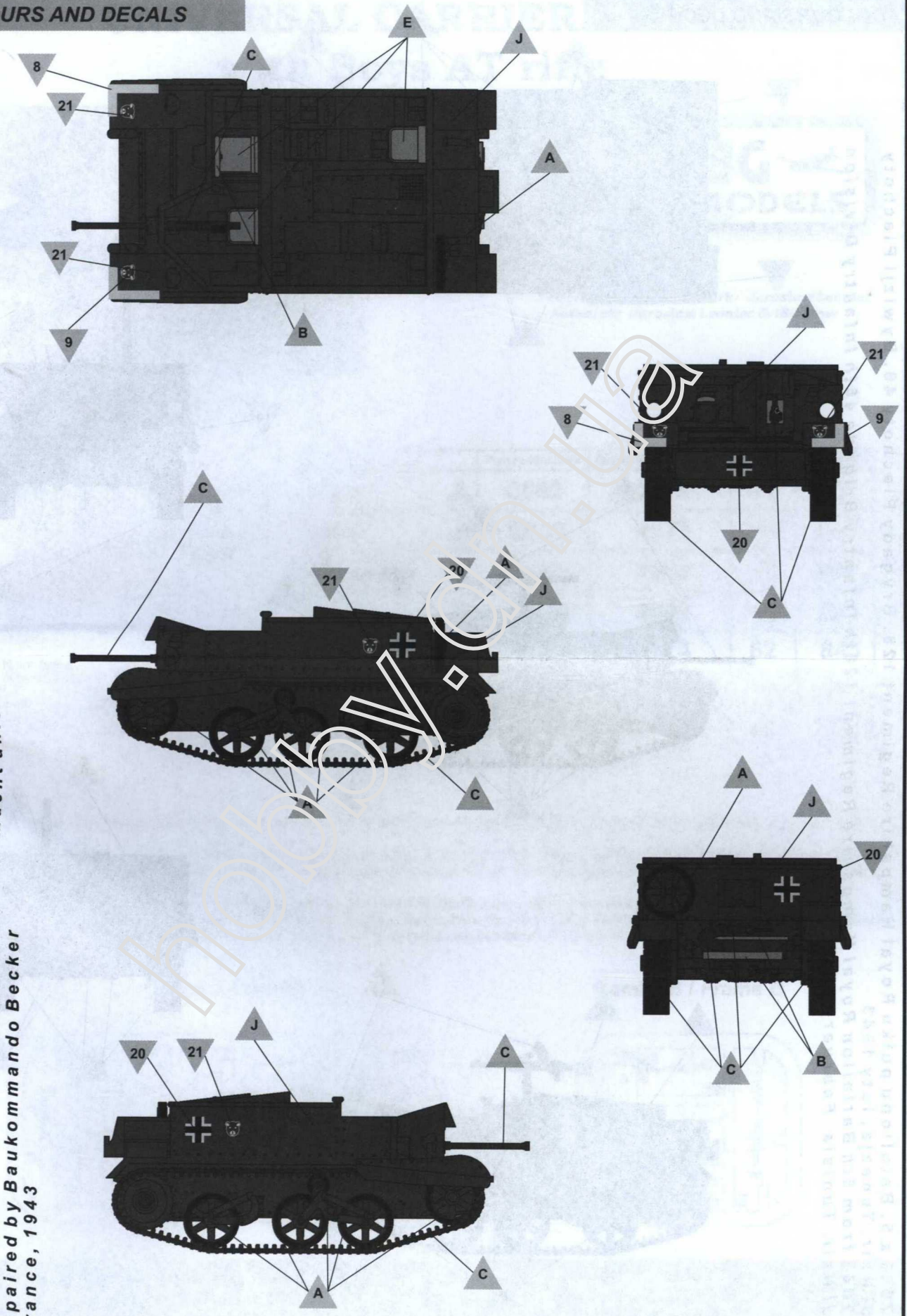

Universal Carrier z niezidentyfikowanej jednostki Wehrmachtu
wymontowany przez Baukommando Becker
Francja, 1943
Universal Carrier from unidentified Wehrmacht unit
repaired by Baukommando Becker
France, 1943

**MALOWANIE I KALKOMANIE
COLOURS AND DECALS**

T17068 z 5. Batalionu pułku Royal Hampshire Regiment 128. Brygady Piechoty 46. Dywizji Piechoty Sidi Nsir, Tunezja, luty 1943
T17068 from 5th Battalion Royal Hampshire Regiment 128th Infantry Brigade 46th Infantry Division Sidi Nsir, Tunisia, February 1943

