



1/35 SCALE

# RUSSIAN BMD-1 Airborne Fighting Vehicle

俄罗斯 BMD-1 伞兵战车

### READ BEFORE ASSEMBLY

组装前请仔细阅读

1. Study and understand these instructions thoroughly before beginning assembly  
· 组装前请仔细阅读以下内容
2. When needed, remove photo-etch parts carefully using a modeling knife or photo etch sprue cutter, be careful not to damage or lose small parts  
请使用专业模型工具仔细去除蚀刻片或胶件上需要剪下的部分，小心不要损坏或丢失
3. Take extra care in handling photo etch parts in order to avoid injury  
在处理蚀刻片的部分时请格外小心，以避免伤害
4. Apply instant cement sparingly to photo etch parts were instructed  
用强力快干胶水粘合蚀刻片零件和金属轴，过量使用快干胶水可能导致可动零件粘住，小心涂胶
5. Tools recommended(not included in kit): Plastic and instant cements, sprue cutters, long nose pliers, modeling knife, small files, tweezers, pin vise & scissors. Soft cloth and sandpaper will also assist in construction  
推荐模型工具(自备): 胶水、水口剪刀、长咀钳、刀片、锉刀、镊子、钳、钻、剪刀、瞬间快干胶
6. Glue and paint are not included in the kit. Use plastic cement and hobby paints only. Color guide for purchasing paint is included in the kit.  
软布与砂纸同时也应该是必备工具，请使用塑料胶水和油漆(模型内不含)

### ICON INSTRUCTION

图标说明



Optional  
选择



Bending  
折弯



Do not stick  
不涂胶水



Decal  
水贴纸



Remove  
切除



Drilling  
钻孔



Fill  
填补



Weight  
配重

Lower hull

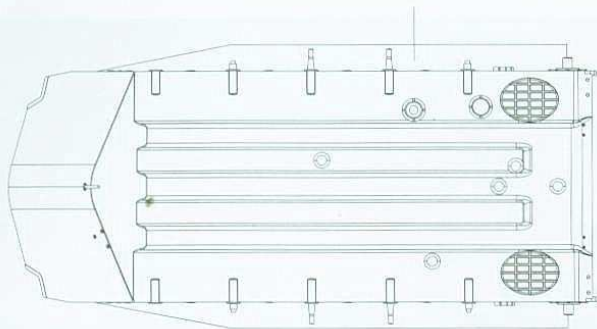

Upper hull

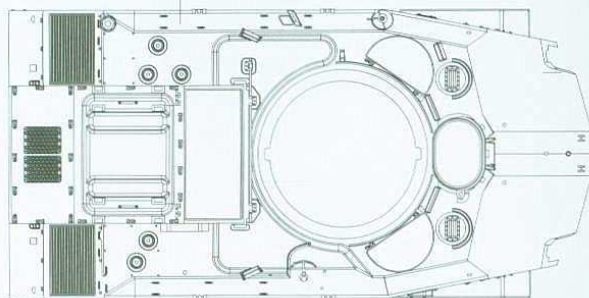

A X2

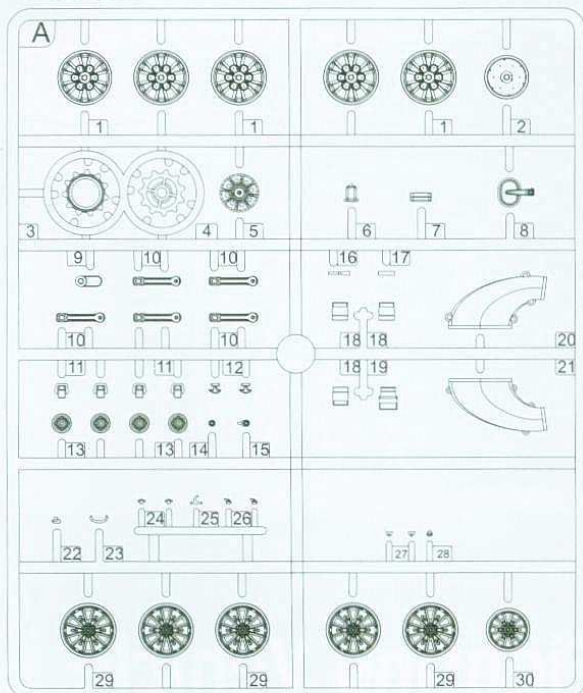

T X4

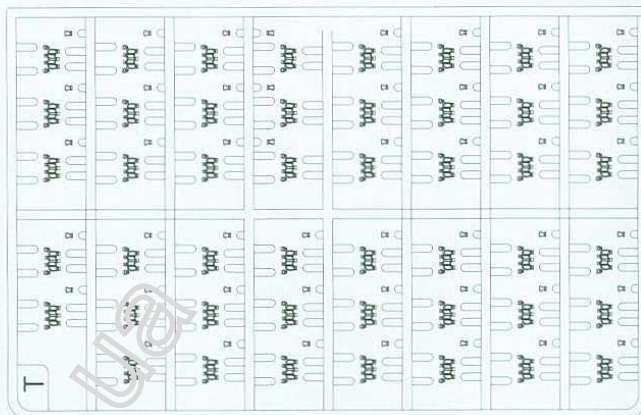

PE

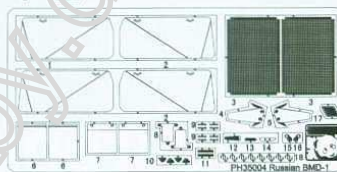

Decal



B

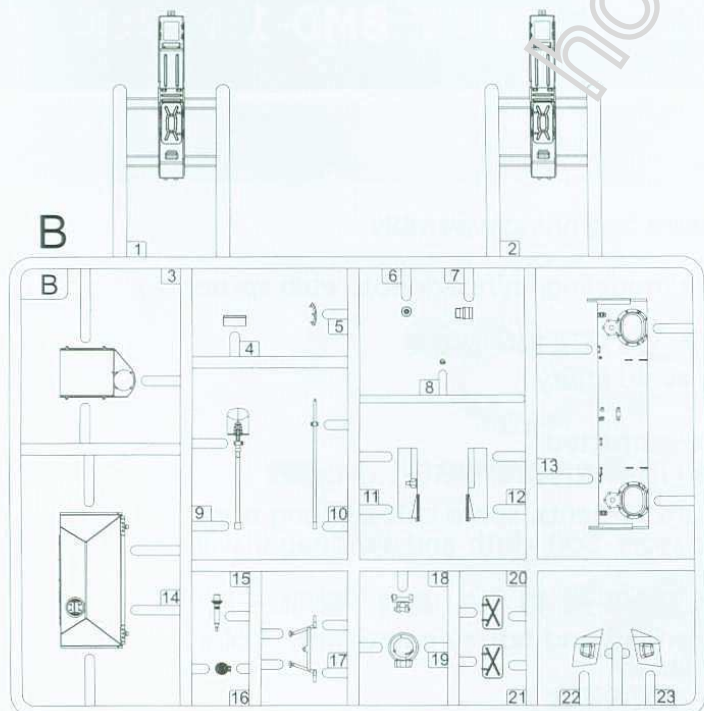

C

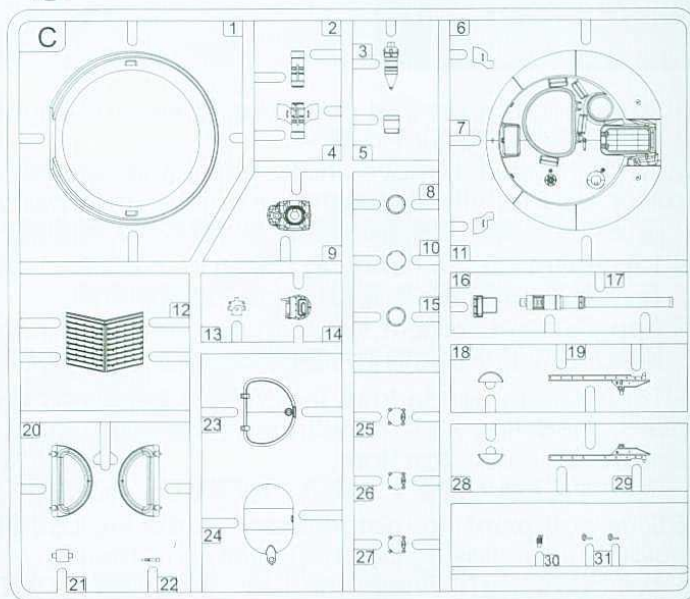

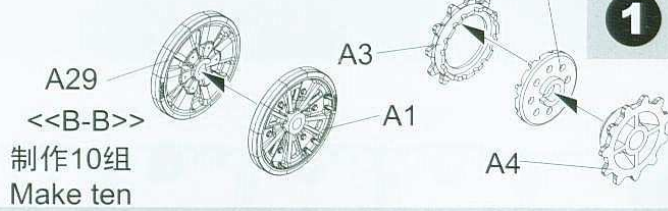
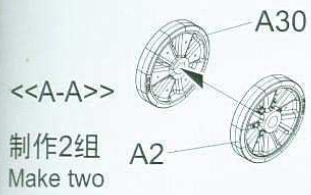

**1**

**ASSEMBLY**  
模型组装

制作2组  
Make two  
<<C-C>>

**2**

**ASSEMBLY**  
模型组装

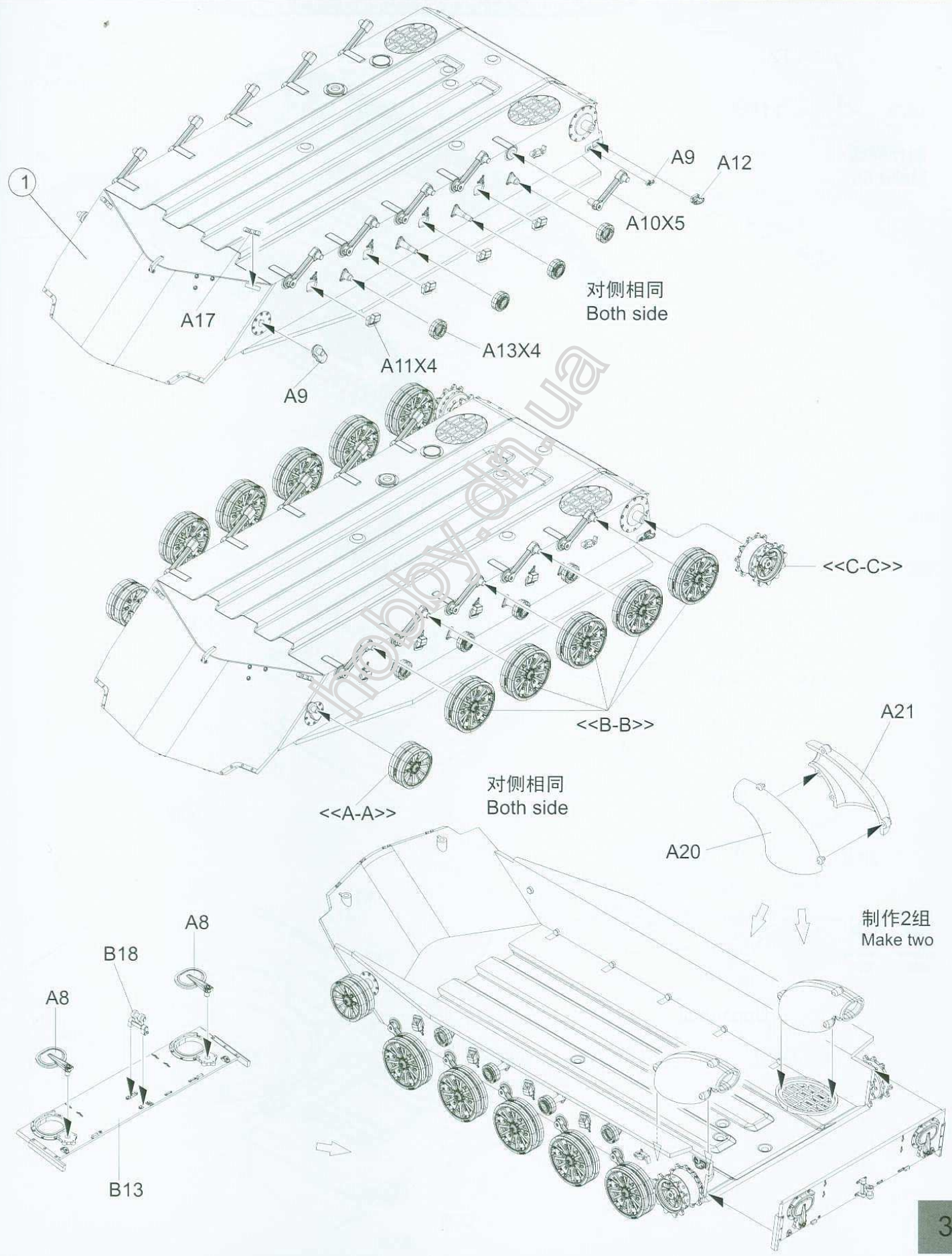

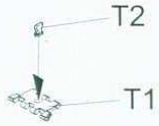
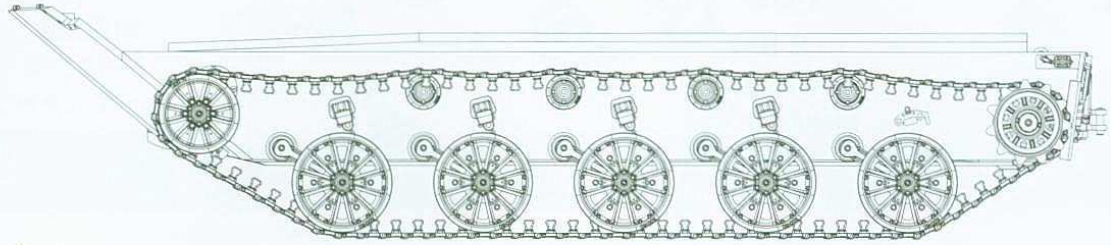

制作88组  
Make 88

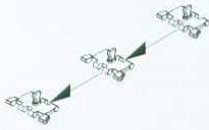

制作2组  
Make two

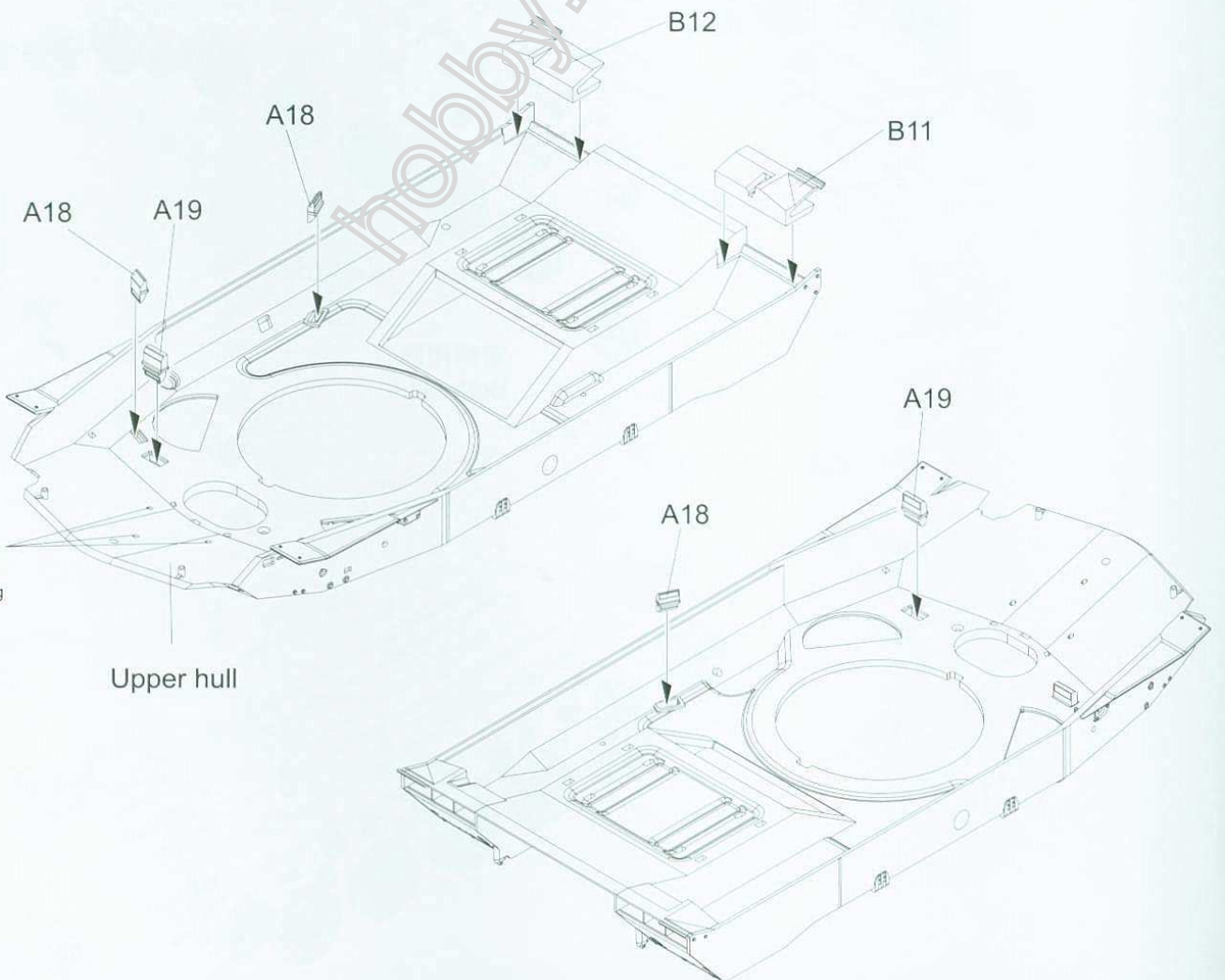
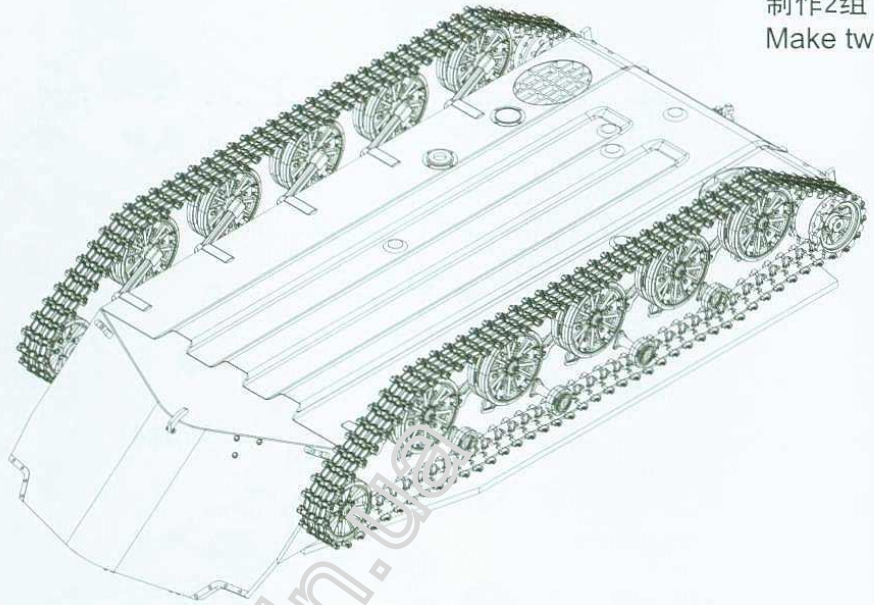

 Optional  
选择

 Drilling  
钻孔

Upper hull

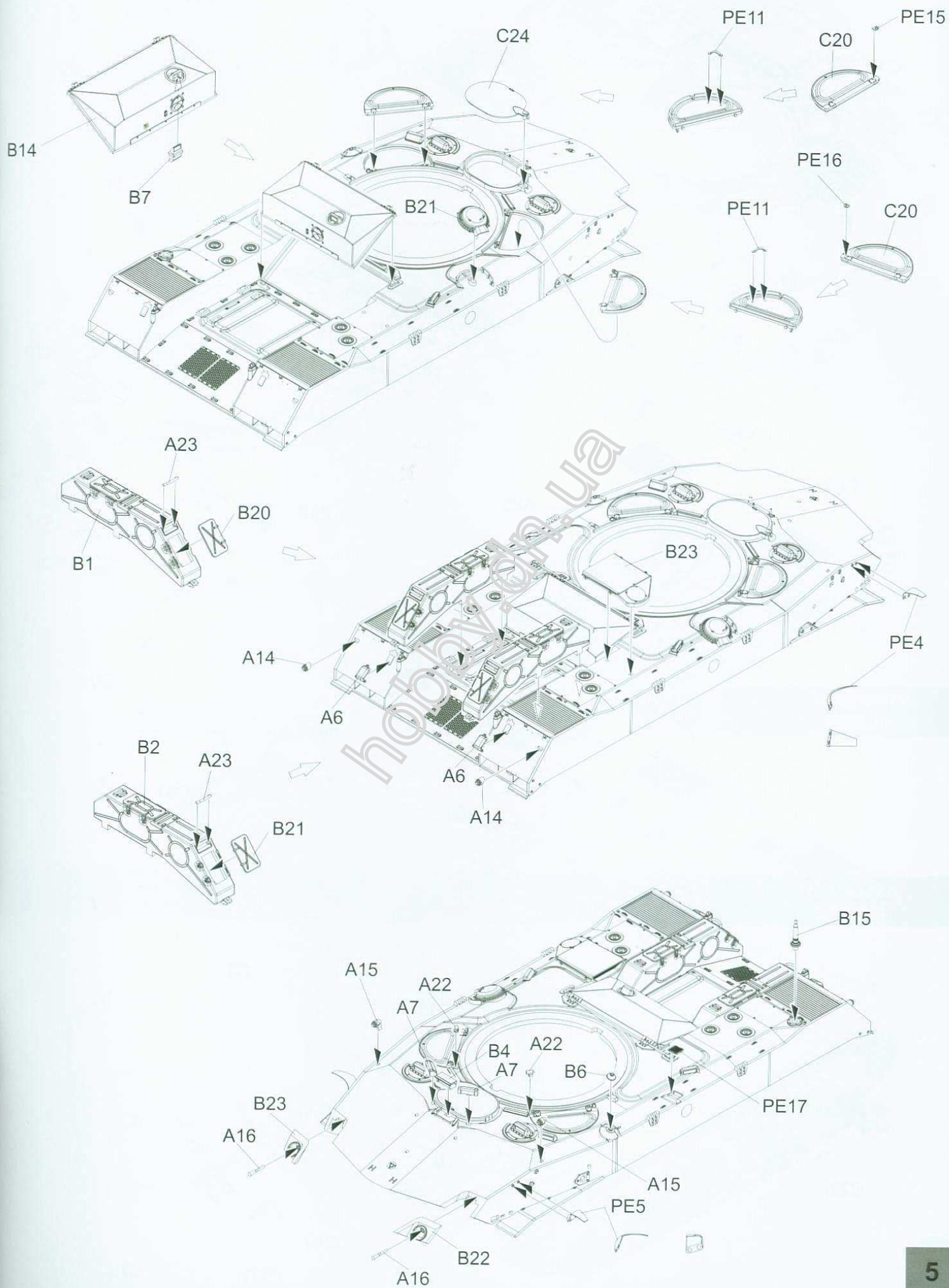

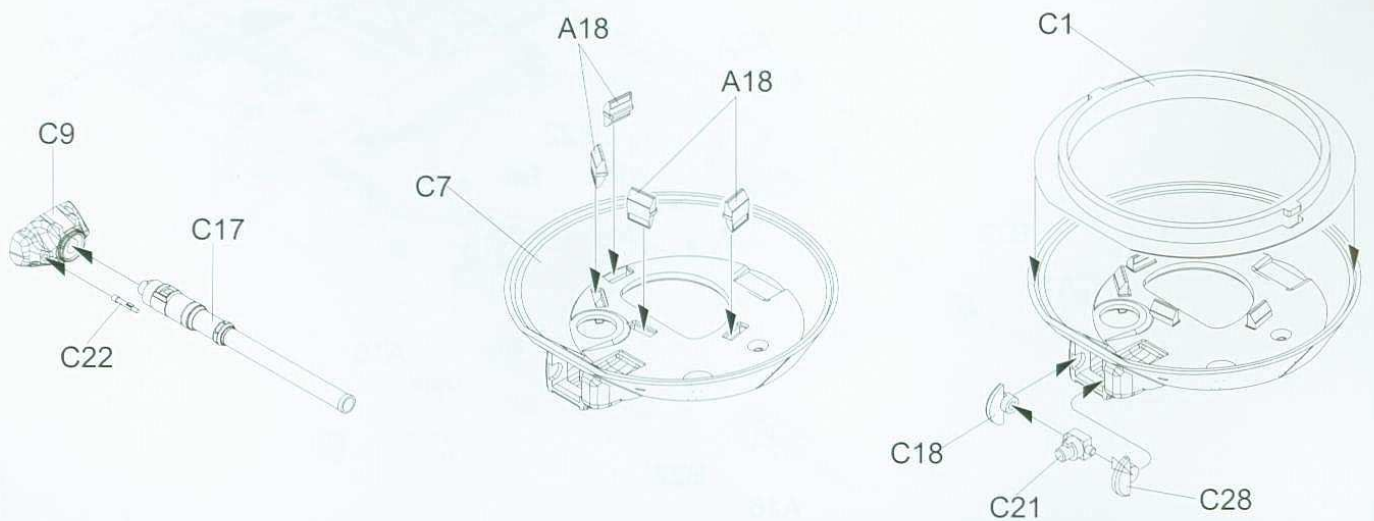
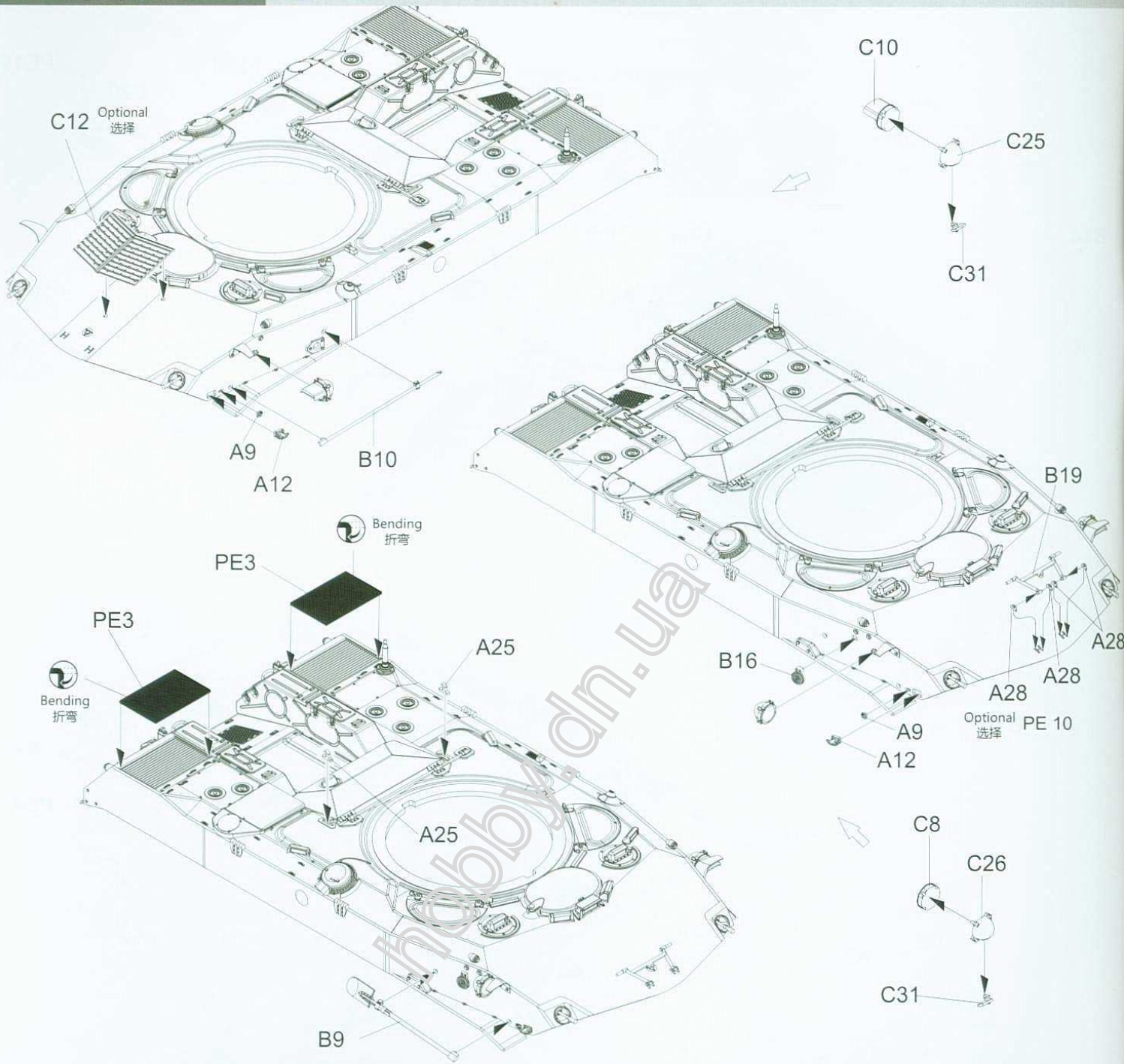

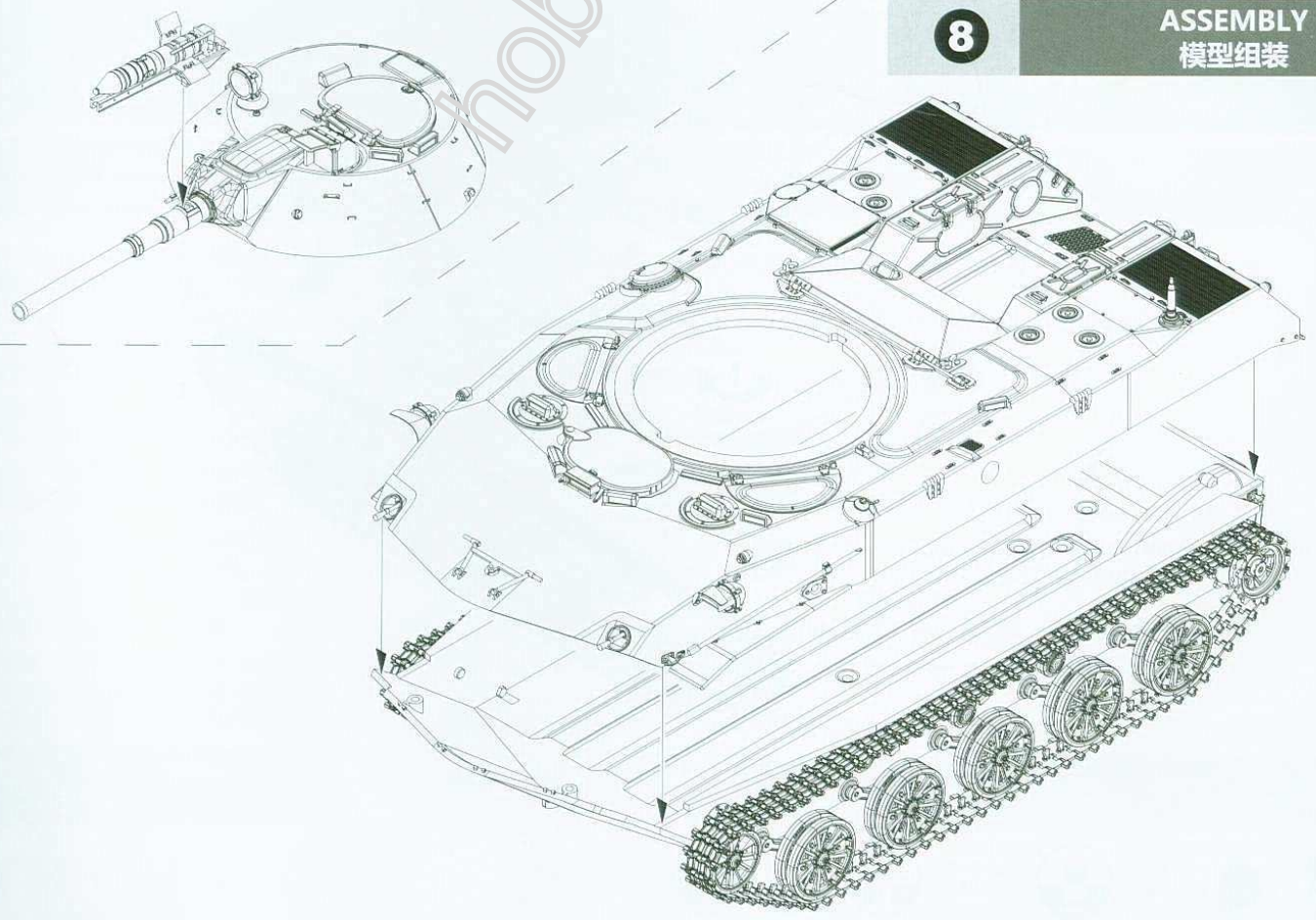
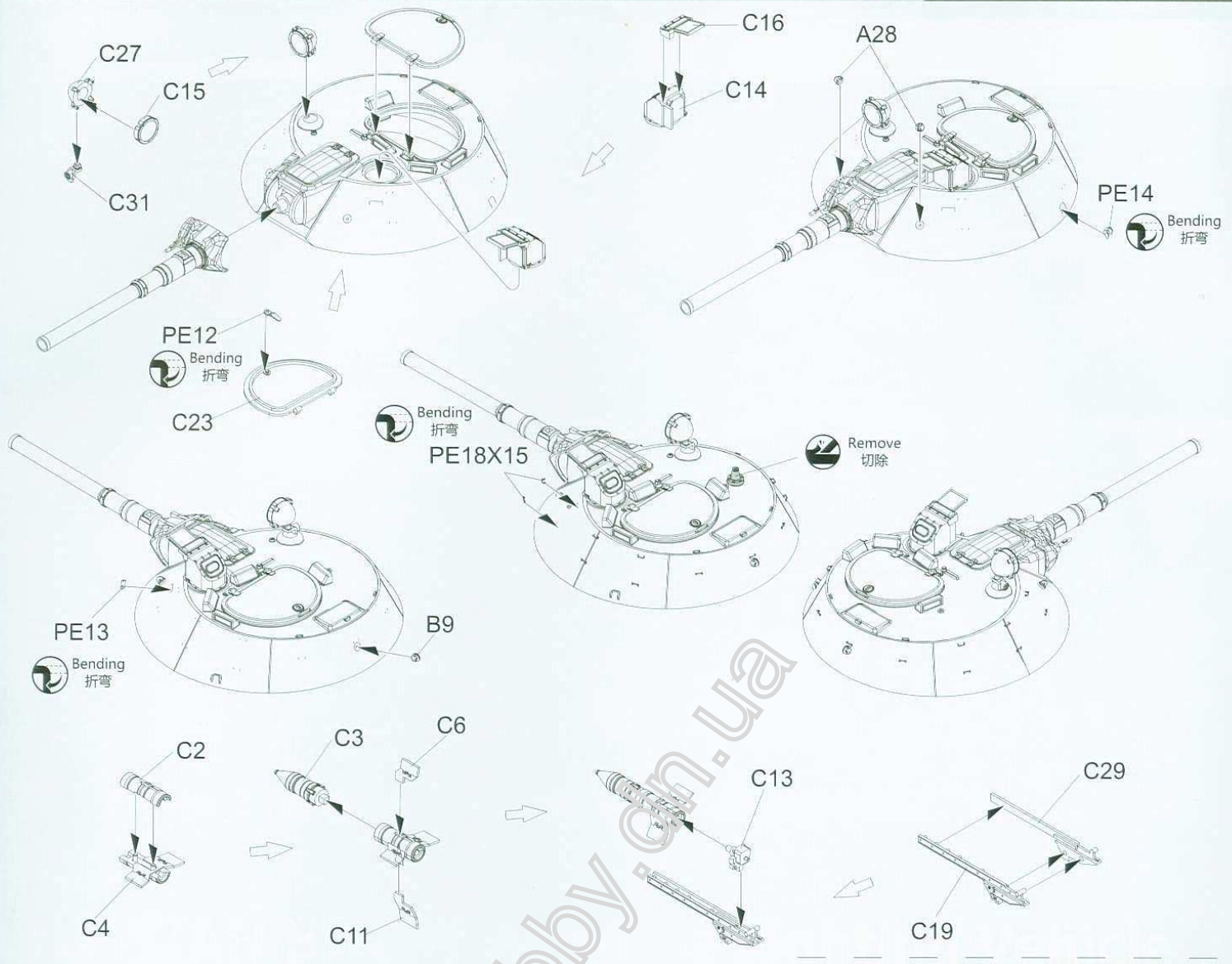

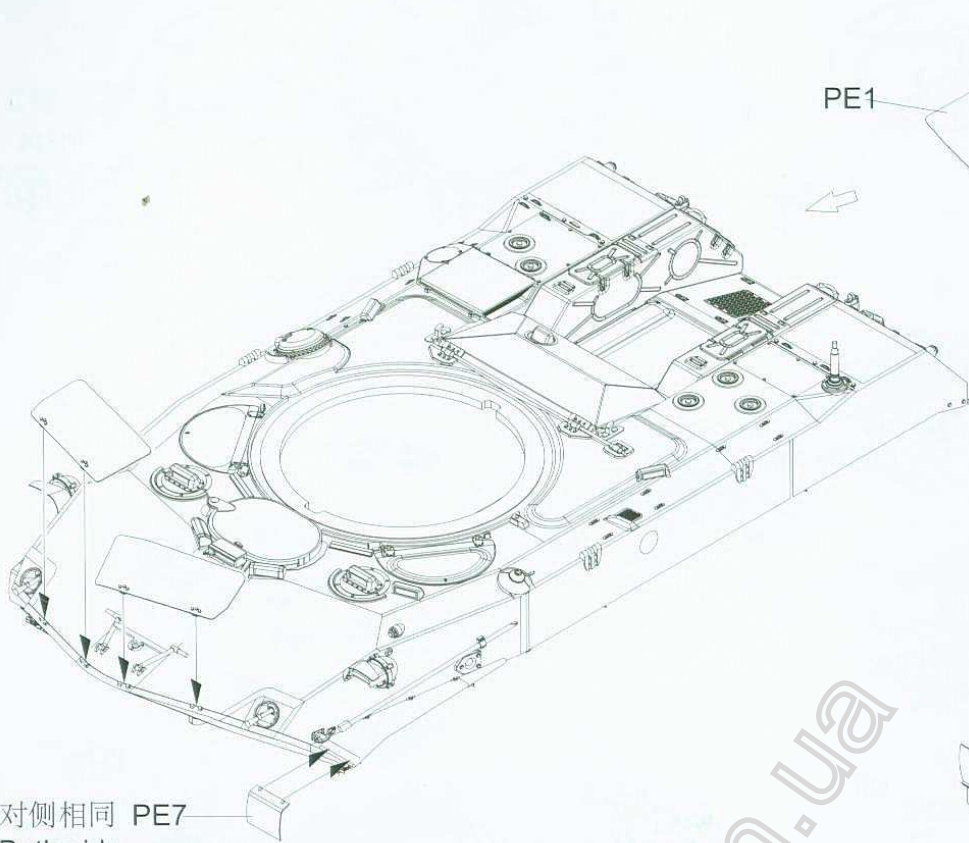

对侧相同 PE7  
Both side

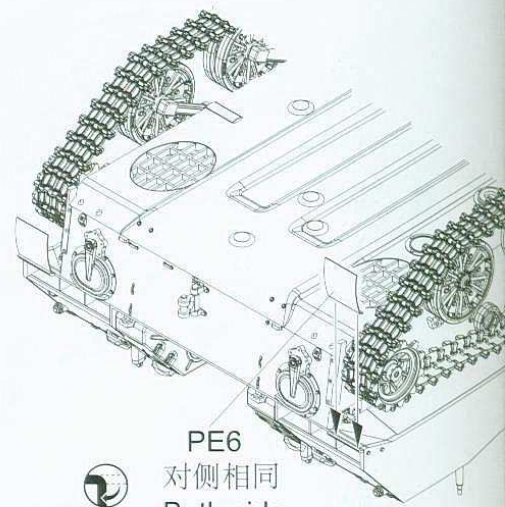
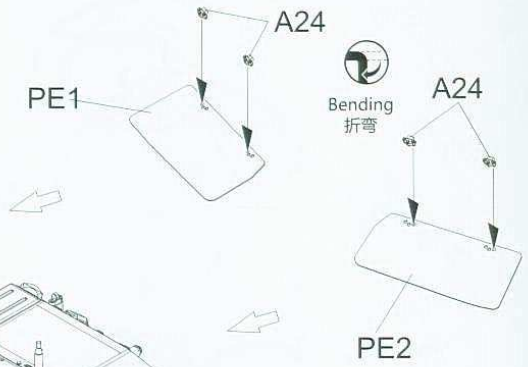
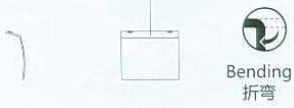

PE6  
对侧相同  
Both side  
Bending  
折弯

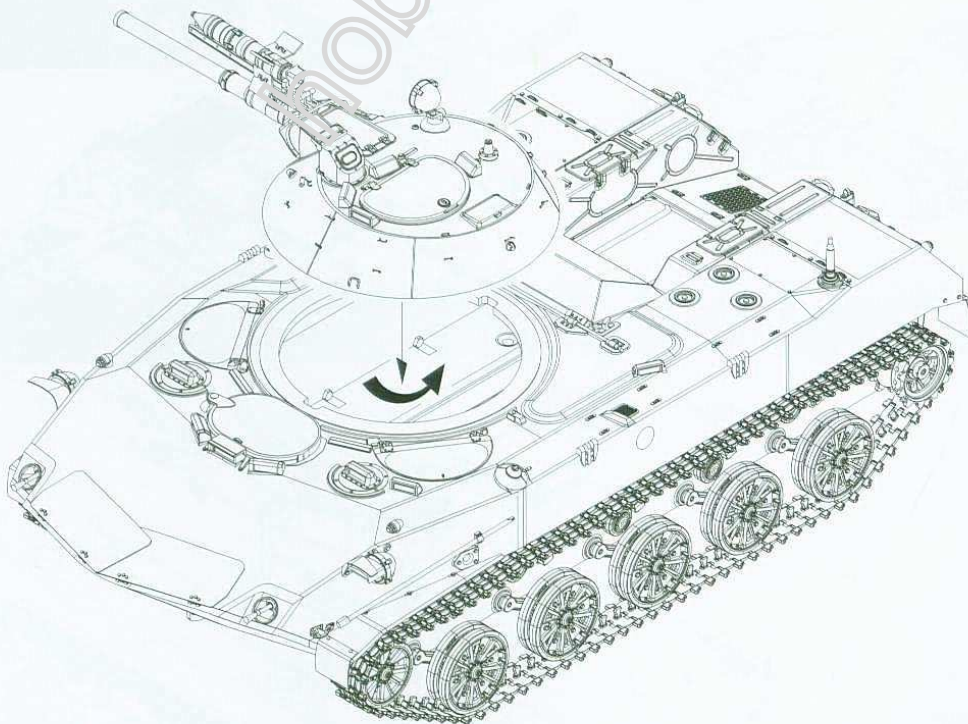





俄羅斯BMD-1傘兵戰車

### 1/35 scale

**A**



**C 303**  
GREEN FS34102  
FS34102 綠

**C 316**  
WHITE FS17875  
FS17875 白色

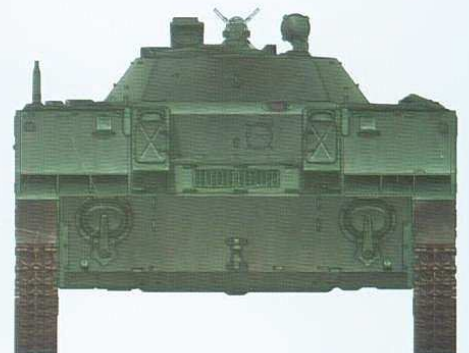
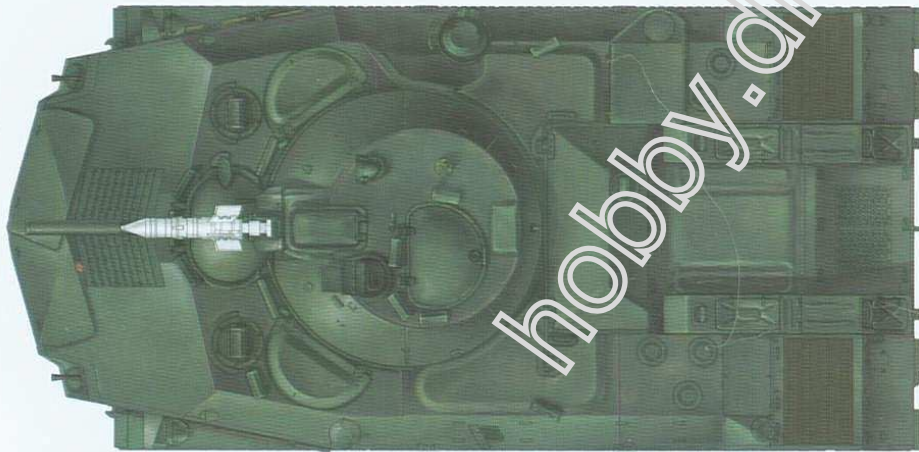

**B**



**C 303**  
GREEN FS34102  
FS34102 綠

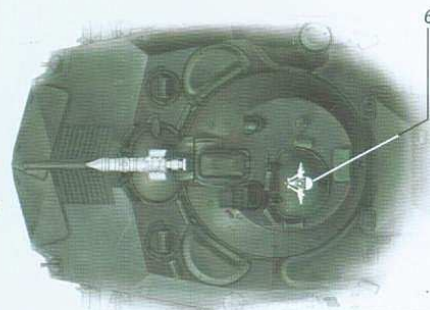

**C**



**C 303**  
GREEN FS34102  
FS34102 綠

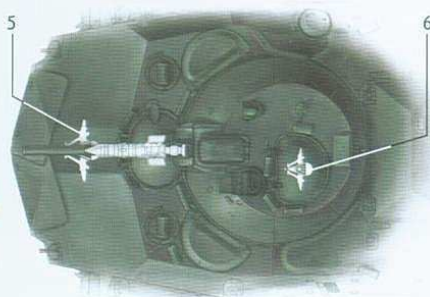

2014 COPYRIGHT  
PANDA HOBBY,  
ALL RIGHTS RESERVED.

**GUNZE SANGYO Mr. color used**

Item No. PH35004  
Illustration by Eric Chan