



06782-0379

LEVEL 3  
1 2 3 4 5



# OUTLAND TIE FIGHTER™

Beiliegenden Sicherheitstext beachten / Please note the enclosed safety advice

- DE Beiliegenden Sicherheitstext beachten und nachschlagbereit halten.
- EN Please note the enclosed safety advice and keep safe for later reference.
- FR Respecter les consignes de sécurité ci-jointes et les conserver à portée de main.
- NL Houdt u aan de bijgaande veiligheidsinstructies en hou deze steeds bij de hand.
- IT Seguire le avvertenze di sicurezza allegate e tenerle a portata di mano.
- ES Observar y siempre tener a disposición este texto de seguridad adjunto.
- PT Ter em atenção o texto de segurança anexo e guardá-lo para consulta.

- DK Overhold vedlagte sikkerhedsanvisninger og hav dem liggende i nærheden.
- NO Ha alltid vedlagt sikkerhetstekst klar til bruk.
- SE Beakta bifogad säkerhetstext och håll den i beredskap.
- FI Huomioi ja säilytä oheiset varoitukset.
- RU Соблюдать технику безопасности, сохранить инструкцию для дальнейших обращений.
- PL Przestrzegać załączonego tekstu dotyczącego bezpieczeństwa i mieć go zawsze pod ręką.
- CZ Dodržujte tento příložený bezpečnostní text a mějte ho po ruce.
- HU A mellékelt biztonsági szöveget vegye figyelembe és tartsa fellepőzásra készen.

- SK Rešpektujte priložený bezpečnostný text a uchovajte ho pre budúce použitie.
- RO Respectați textul de siguranță atașat și păstrați-l la îndemână.
- HR Spazivajte priloženja tekst za bezopasnost i to držite pod rjka za spravki.
- S Prilolena varnostna navodila izvajajte in jih hranite na vsem dostopnem mestu.
- GR Λάβετε υπόψη σας το συννημένο κείμενο ασφαλείας και φυλάξτε το ώστε να ανατρέχετε σε αυτό όποτε χρειάζεται.
- TR Ekteki güvenliik talimatlarını dikkate alıp, bakabileceğiniz bir şekilde muafaza ediniz.

© 2021 Revell GmbH, Henschelstr. 20-30, D-32257 Bünde.

REVELL IS THE REGISTERED TRADEMARK OF REVELL GMBH, GERMANY. [www.revell.de](http://www.revell.de)

© & ™ Lucasfilm Ltd.

[www.starwars.com](http://www.starwars.com)

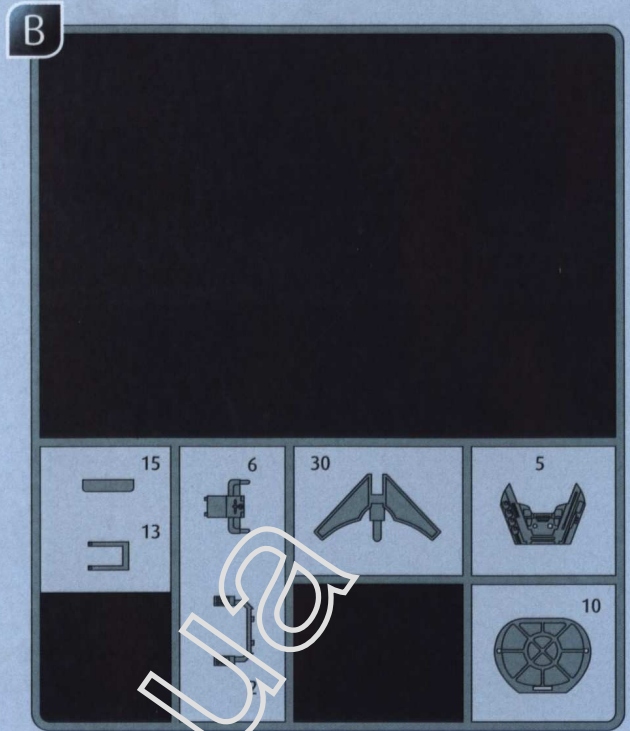
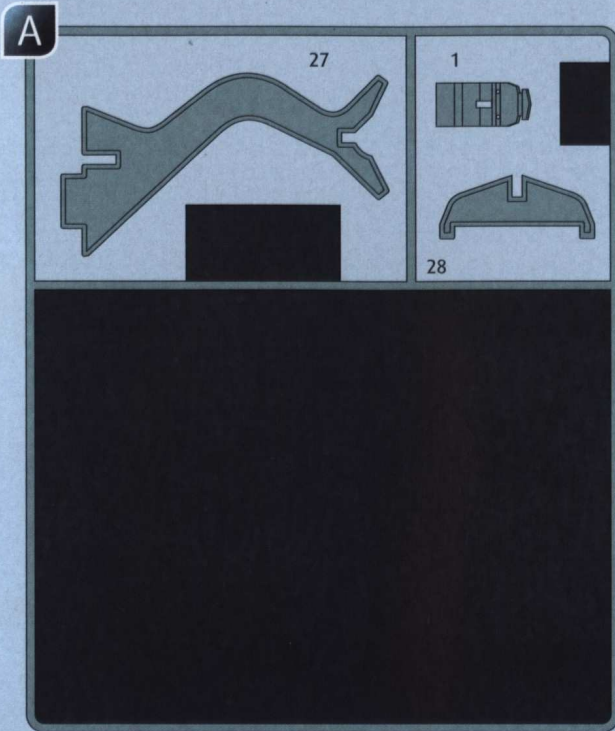

(DE) Nicht benötigte Teile  
 (GB) Parts not used.  
 (FR) Pièces non utilisées.  
 (NL) Niet benodigde onderdelen.  
 (IT) Parti non necessarie.  
 (ES) Piezas no utilizadas.  
 (PT) Peças não utilizadas.

(DK) Dele der ikke skal bruges.  
 (NO) Deler som ikke er nødvendige.  
 (SE) Ej nödvändiga delar.  
 (FI) Tarpeettomat osat.  
 (RU) Неиспользуемые детали.  
 (PL) Niepotrzebne części.  
 (CZ) Nepotřebné díly.

(HU) Szükségtelen alkatrészek.  
 (SK) Nepotrebné diely.  
 (SI) Piese care nu sunt necesare.  
 (BG) Ненужни детайли.  
 (GR) Nepotrebni deli.  
 (TR) Mı gerekmeyen parçalar.  
 (CY) Gerekli olmayan parçalar.

(DE) Kundenservice: [www.revell-service.de](http://www.revell-service.de) oder **Revell GmbH, Abteilung X, Henschelstr. 20-30, D-32257 Bünde** (nur für DE, AT, NL, BE, LU, ES, IT, PL, US, CA). Für alle übrigen Länder kontaktieren Sie ausschließlich Ihren Händler oder Distributor.

(GB) Customer Service: [www.revell-service.de/en](http://www.revell-service.de/en) or **Revell UK Ltd, Unit 10, Old Airfield Industrial Estate, Cheddington Lane, Tring HP23 4QR, United Kingdom** (only for DE, AT, NL, BE, LU, ES, IT, PL, US, CA). For all other countries please contact your dealer or distributor only.

(FR) Service clientèle: [www.revell-service.de/en](http://www.revell-service.de/en) or **Revell GmbH, Department X, Henschelstr. 20-30, D-32257 Bünde, Germany** (only for DE, AT, NL, BE, LU, ES, IT, PL, US, CA). For all other countries please contact your dealer or distributor only.

(NL) Klantenservice: [www.revell-service.de](http://www.revell-service.de) of **Revell GmbH, Abteilung X, Henschelstr. 20-30, D-32257 Bünde** (alleen voor DE, AT, NL, BE, LU, ES, IT, PL, US, CA). Voor alle andere landen kunt u alleen contact opnemen met uw dealer of distributeur.

(ES) Servicio al cliente: [www.revell-service.de](http://www.revell-service.de) o **Revell GmbH, Abteilung X, Henschelstr. 20-30, D-32257 Bünde** (sólo para DE, AT, NL, BE, LU, ES, IT, PL, US, CA). Para todos los demás países, por favor, póngase en contacto con su proveedor o distribuidor solamente.

(IT) Servizio clienti: [www.revell-service.de](http://www.revell-service.de) o **Revell GmbH, Abteilung X, Henschelstr. 20-30, D-32257 Bünde** (solo per DE, AT, NL, BE, LU, ES, IT, PL, US, CA). Per tutti gli altri paesi si prega di contattare esclusivamente il proprio rivenditore o distributore.

(PT) Serviço de apoio ao cliente: [www.revell-service.de](http://www.revell-service.de) ou **Revell GmbH, Abteilung X, Henschelstr. 20-30, D-32257 Bünde** (apenas para DE, AT, NL, BE, LU, ES, IT, PL, US, CA). Para todos os outros países, contacte apenas o seu revendedor ou distribuidor.

(DK) Kundenservice: [www.revell-service.de](http://www.revell-service.de) eller **Revell GmbH, Abteilung X, Henschelstr. 20-30, D-32257 Bünde** (kun for DE, AT, NL, BE, LU, ES, IT, PL, US, CA). For alle øvrige lande bedes du udelukkende kontakte din forhandler eller distributør.

(NO) Kundenservice: [www.revell-service.de](http://www.revell-service.de) eller **Revell GmbH, Abteilung X, Henschelstr. 20-30, D-32257 Bünde** (kun for DE, AT, NL, BE, LU, ES, IT, PL, US, CA). For alle andre land gjelder at all kontakt skal skje via din forhandler eller distributør.

(SE) Kundtjänst: [www.revell-service.de](http://www.revell-service.de) eller **Revell GmbH, Abteilung X, Henschelstr. 20-30, D-32257 Bünde** (endast för DE, AT, NL, BE, LU, ES, IT, PL, US, CA). För övriga länder var god kontakta återförsäljaren eller distributören.

(FI) Asiakaspalvelu: [www.revell-service.de](http://www.revell-service.de) tai **Revell GmbH, Abteilung X, Henschelstr. 20-30, D-32257 Bünde** (vain DE, AT, NL, BE, LU, ES, IT, PL, US, CA). Muiden maiden kohdalla ota yhteyttä paikalliseen jälleenmyyjään tai jakelijaan.

(RU) Служба поддержки клиентов: [www.revell-service.de](http://www.revell-service.de) или **Revell GmbH, Abteilung X, Henschelstr. 20-30, D-32257 Bünde** (только для DE, AT, NL, BE, LU, ES, IT, PL, US, CA). Клиентам из других стран следует обращаться исключительно к своему поставщику или дистрибьютору.

(PL) Dział obsługi klienta: [www.revell-service.de](http://www.revell-service.de) lub **Revell GmbH, Abteilung X, Henschelstr. 20-30, D-32257 Bünde** (tylko dla DE, AT, NL, BE, LU, ES, IT, PL, US, CA). We wszystkich pozostałych krajach należy kontaktować się wyłącznie ze sprzedawcą lub dystrybutorem.

(CZ) Zákaznický servis: [www.revell-service.de](http://www.revell-service.de) nebo **Revell GmbH, Abteilung X, Henschelstr. 20-30, D-32257 Bünde** (pouze pro DE, AT, NL, BE, LU, ES, IT, PL, US, CA). Pro všechny ostatní země kontaktujte výlučně svého obchodníka nebo prodejce.

(HU) Ügyfélszolgálat: [www.revell-service.de](http://www.revell-service.de) vagy **Revell GmbH, Abteilung X, Henschelstr. 20-30, D-32257 Bünde** (csak DE, AT, NL, BE, LU, ES, IT, PL, US, CA országok esetében). Az egyéb országok esetének kizárólag kereskedőjével, vagy forgalmazójával vegye fel a kapcsolatot.

(SK) Zákaznícky servis: [www.revell-service.de](http://www.revell-service.de) alebo **Revell GmbH, Abteilung X, Henschelstr. 20-30, D-32257 Bünde** (iba pre DE, AT, NL, BE, LU, ES, IT, PL, US, CA). Pre všetky ostatné krajiny kontaktujte výlučne svojho obchodníka alebo predajcu.

(GR) Müşteri hizmetleri: [www.revell-service.de](http://www.revell-service.de) veya **Revell GmbH, Abteilung X, Henschelstr. 20-30, D-32257 Bünde** (sadece DE, AT, NL, BE, LU, ES, IT, PL, US, CA) için. Tüm diğer ülkeler için sadece satıcınıza veya distribütörünüze başvurun.

(TR) Müşteri hizmetleri: [www.revell-service.de](http://www.revell-service.de) veya **Revell GmbH, Abteilung X, Henschelstr. 20-30, D-32257 Bünde** (sadece DE, AT, NL, BE, LU, ES, IT, PL, ABD, CA için). Tüm diğer ülkeler için sadece satıcınıza veya distribütörünüze başvurun.

(CY) Müşteri hizmetleri: [www.revell-service.de](http://www.revell-service.de) veya **Revell GmbH, Abteilung X, Henschelstr. 20-30, D-32257 Bünde** (sadece DE, AT, NL, BE, LU, ES, IT, PL, ABD, CA için). Tüm diğer ülkeler için sadece satıcınıza veya distribütörünüze başvurun.

(CY) Müşteri hizmetleri: [www.revell-service.de](http://www.revell-service.de) veya **Revell GmbH, Abteilung X, Henschelstr. 20-30, D-32257 Bünde** (sadece DE, AT, NL, BE, LU, ES, IT, PL, ABD, CA için). Tüm diğer ülkeler için sadece satıcınıza veya distribütörünüze başvurun.

(CY) Müşteri hizmetleri: [www.revell-service.de](http://www.revell-service.de) veya **Revell GmbH, Abteilung X, Henschelstr. 20-30, D-32257 Bünde** (sadece DE, AT, NL, BE, LU, ES, IT, PL, ABD, CA için). Tüm diğer ülkeler için sadece satıcınıza veya distribütörünüze başvurun.

(CY) Müşteri hizmetleri: [www.revell-service.de](http://www.revell-service.de) veya **Revell GmbH, Abteilung X, Henschelstr. 20-30, D-32257 Bünde** (sadece DE, AT, NL, BE, LU, ES, IT, PL, ABD, CA için). Tüm diğer ülkeler için sadece satıcınıza veya distribütörünüze başvurun.

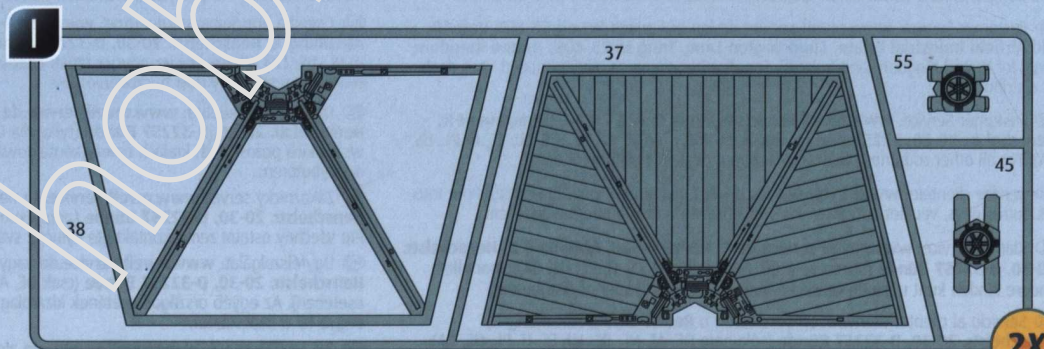
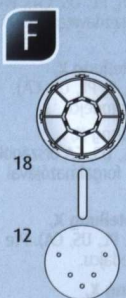
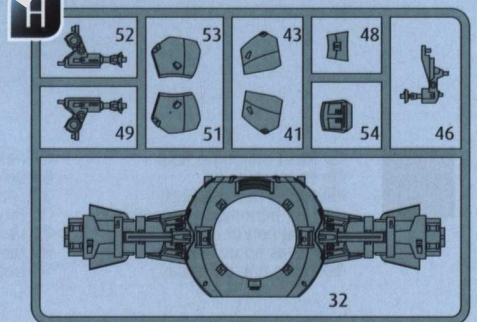
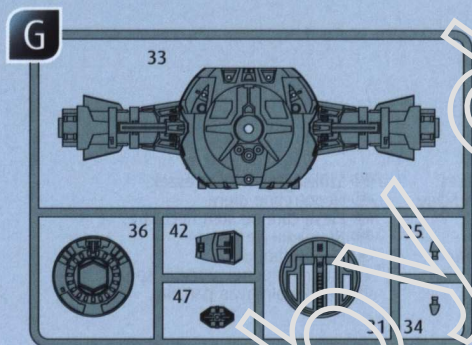
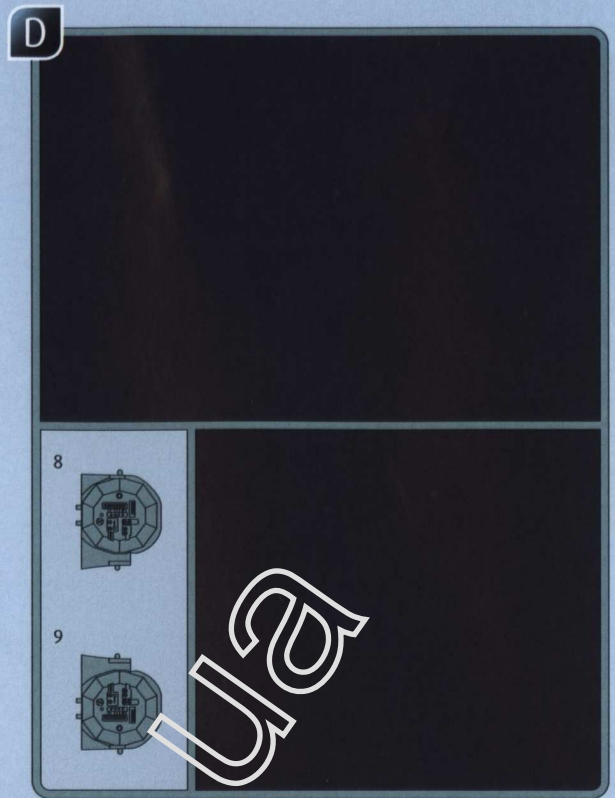
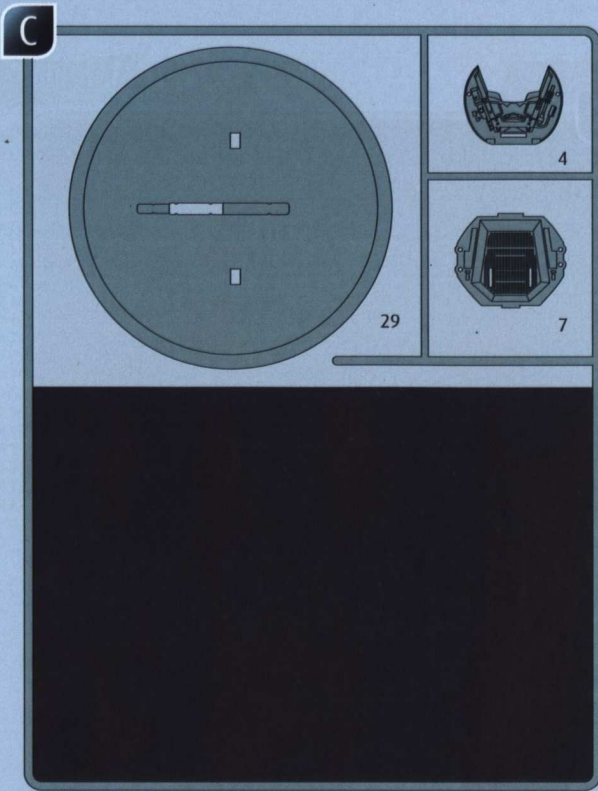

2X

Clear

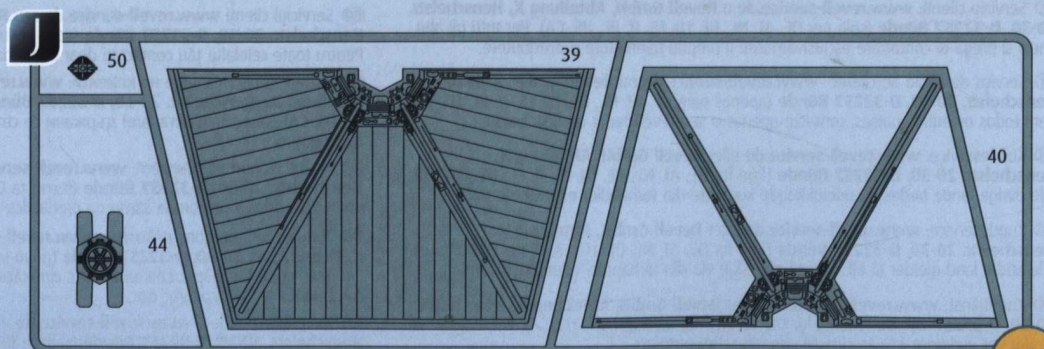

2X

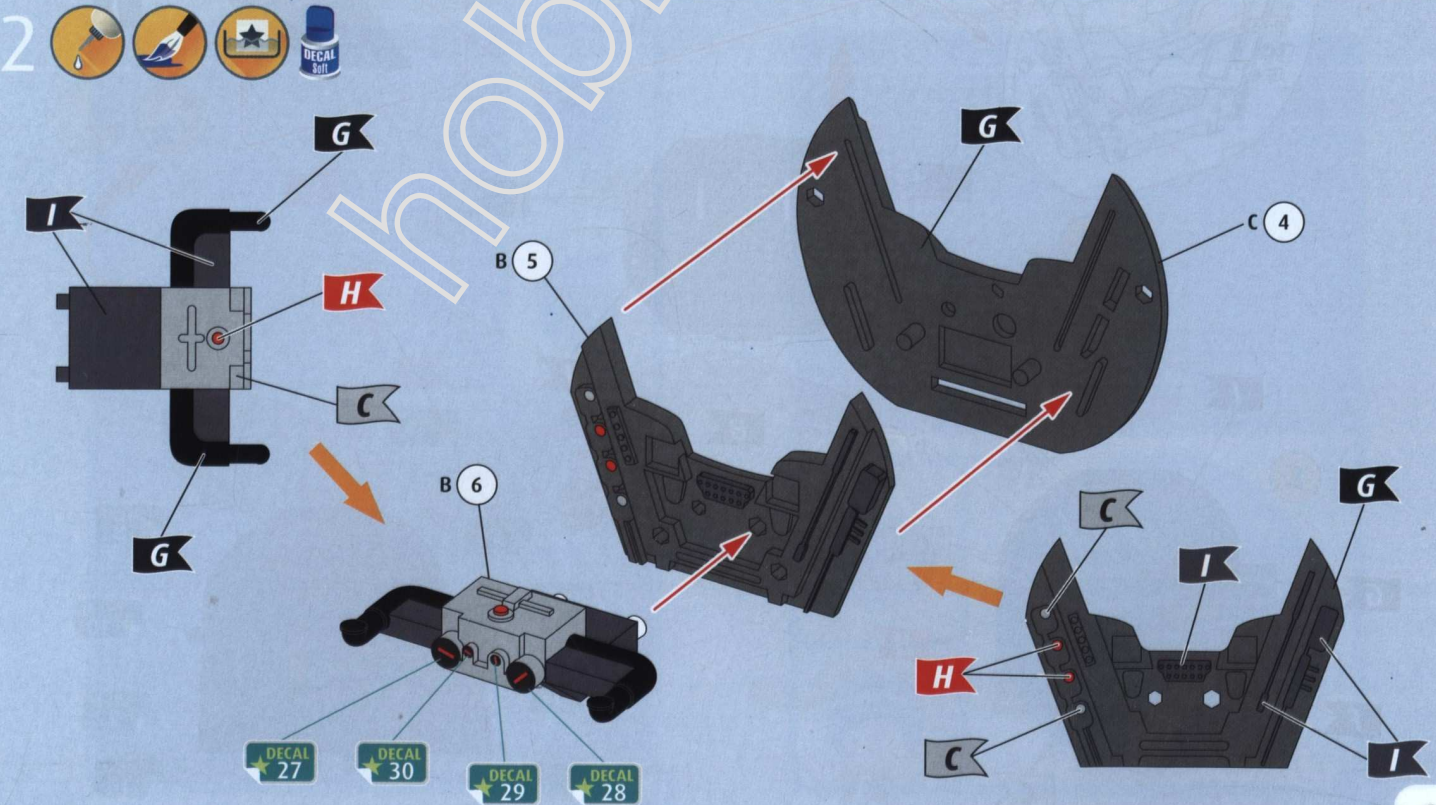
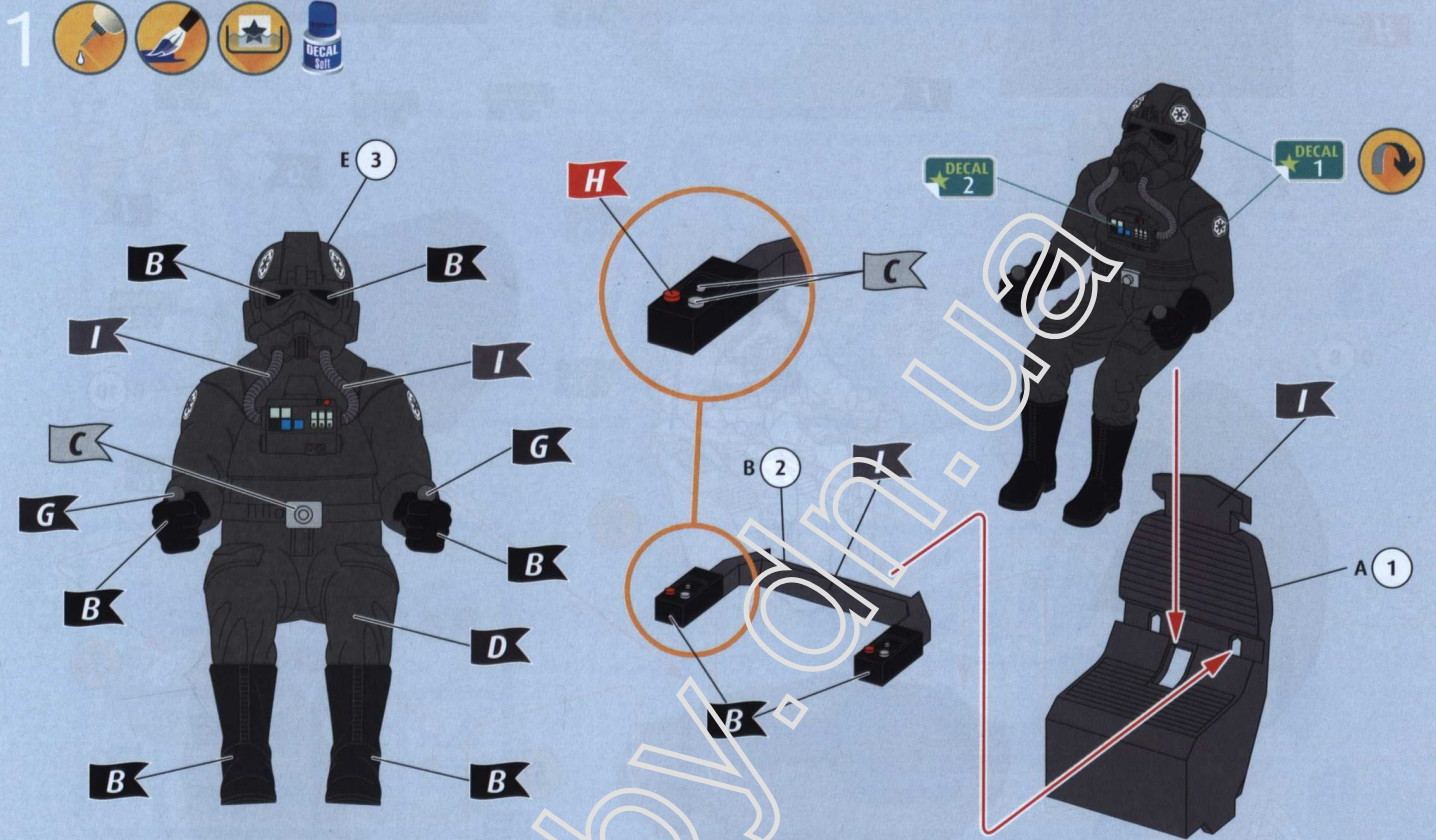
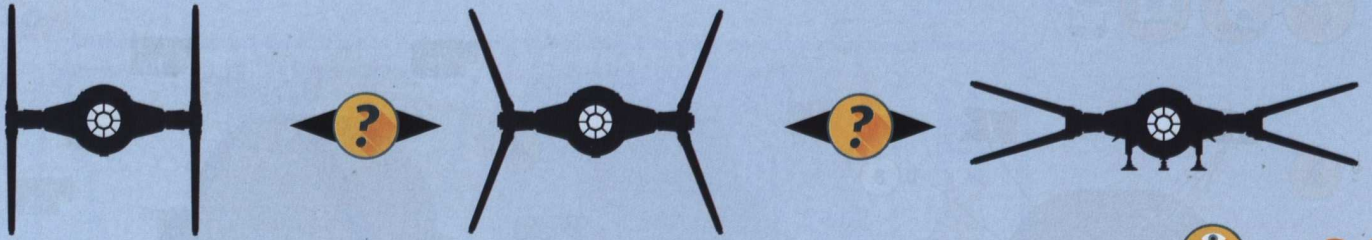

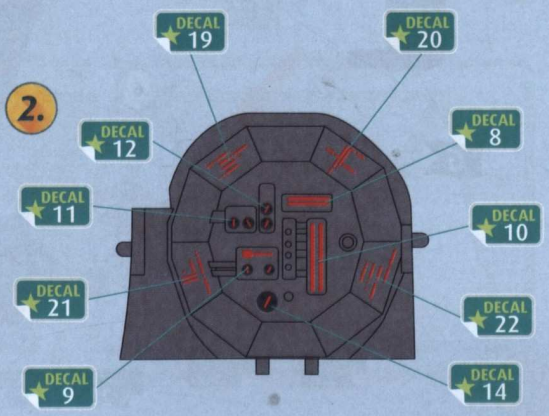
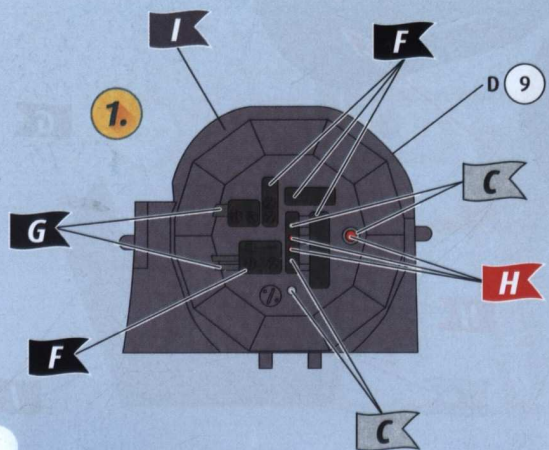
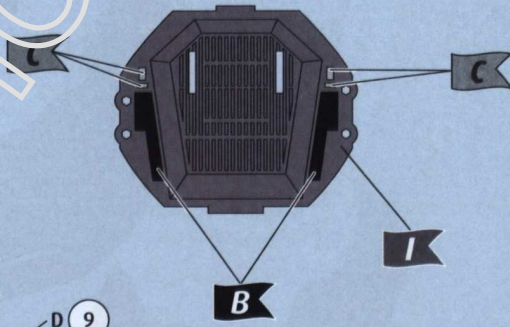
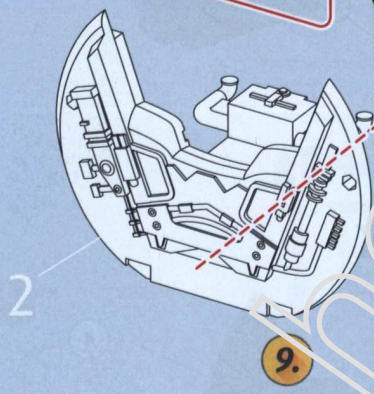
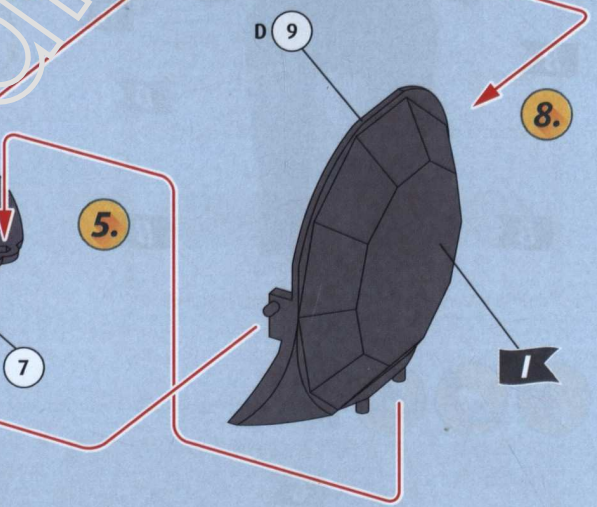
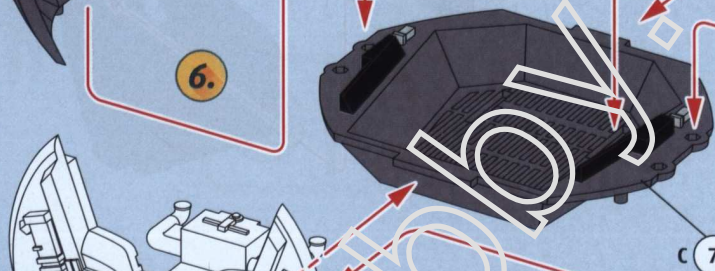
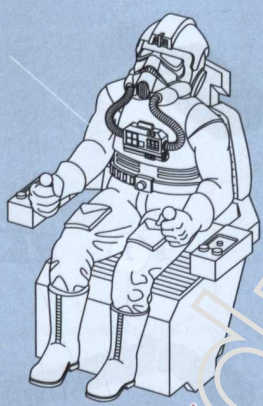
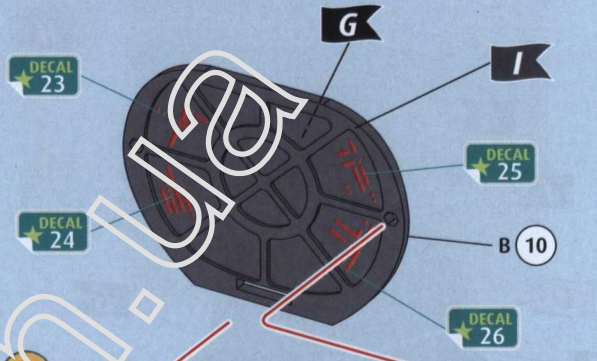
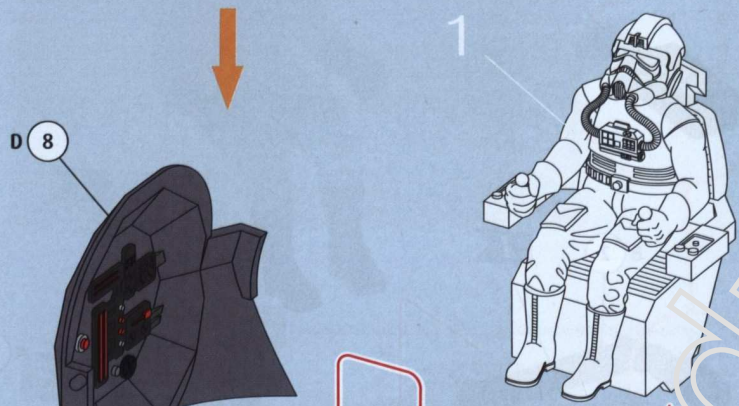
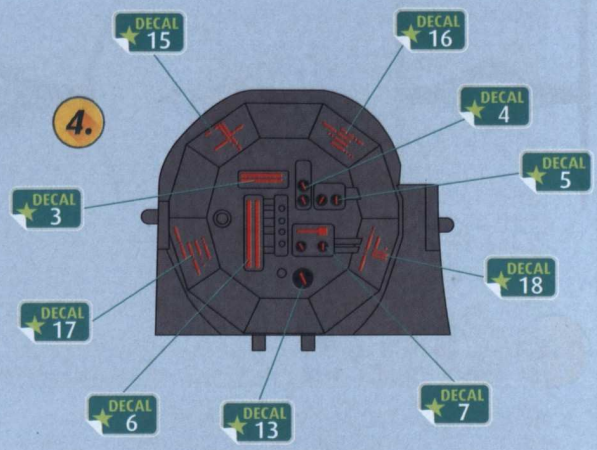
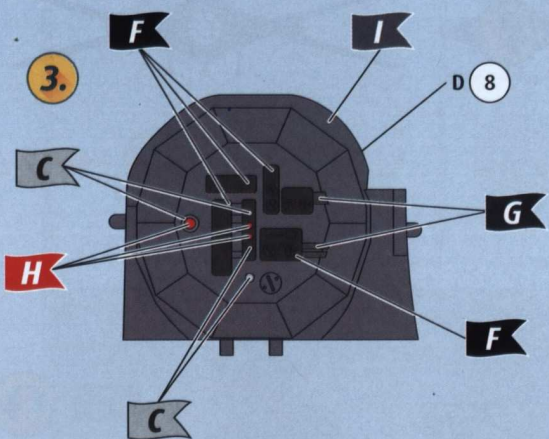

4 

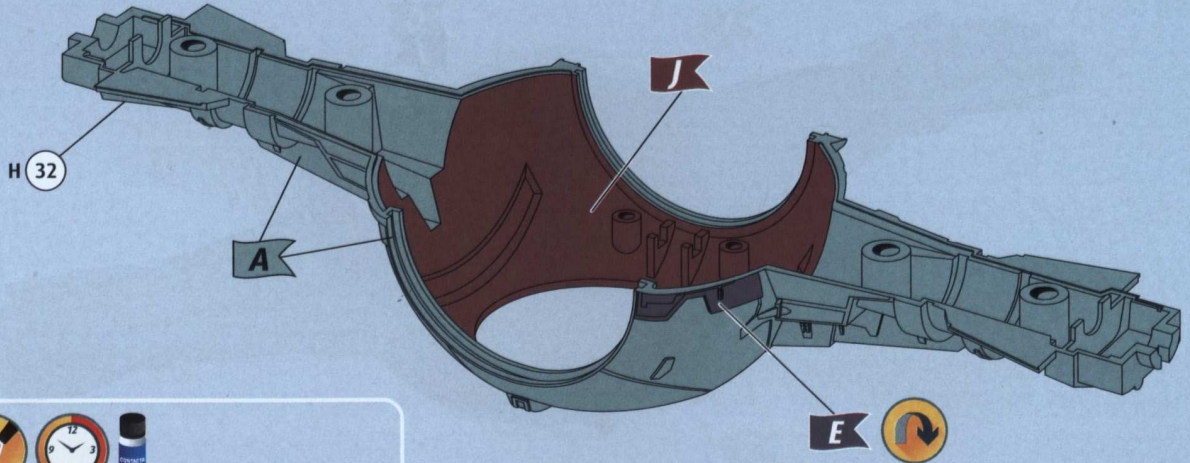

5    

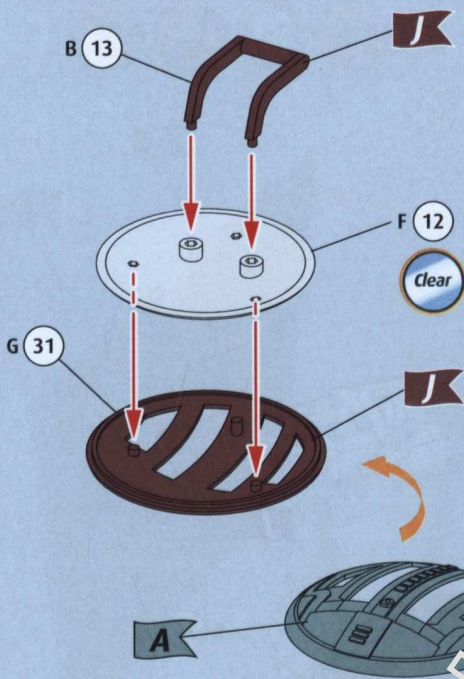

6  

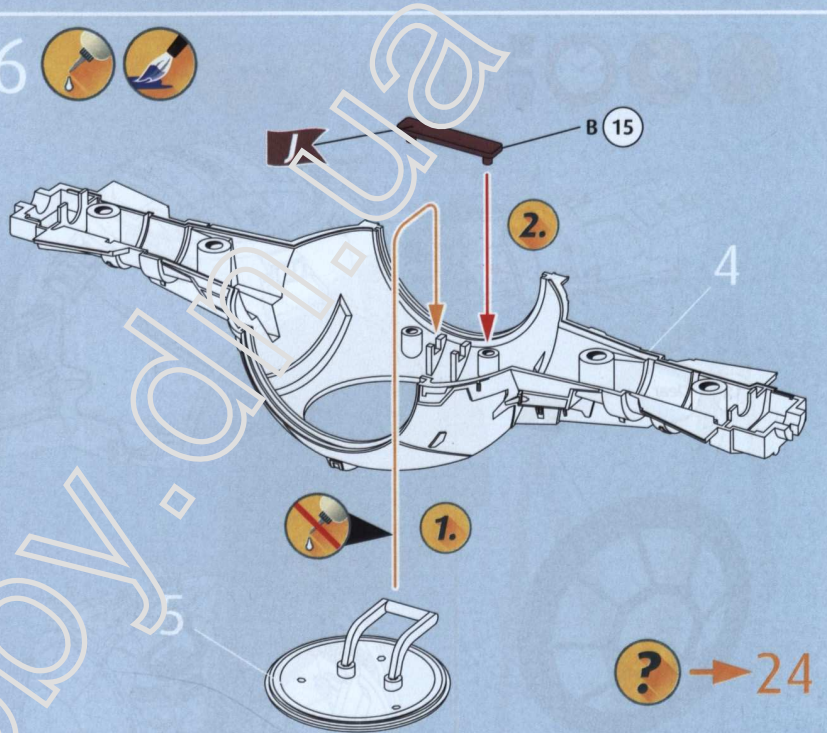

7  

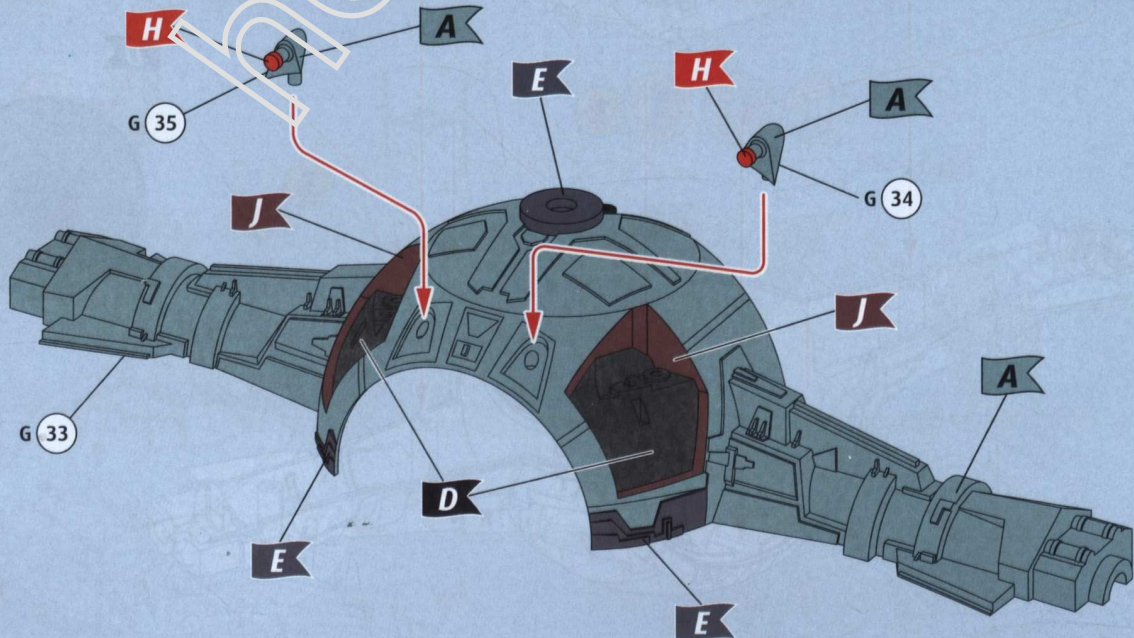

8 

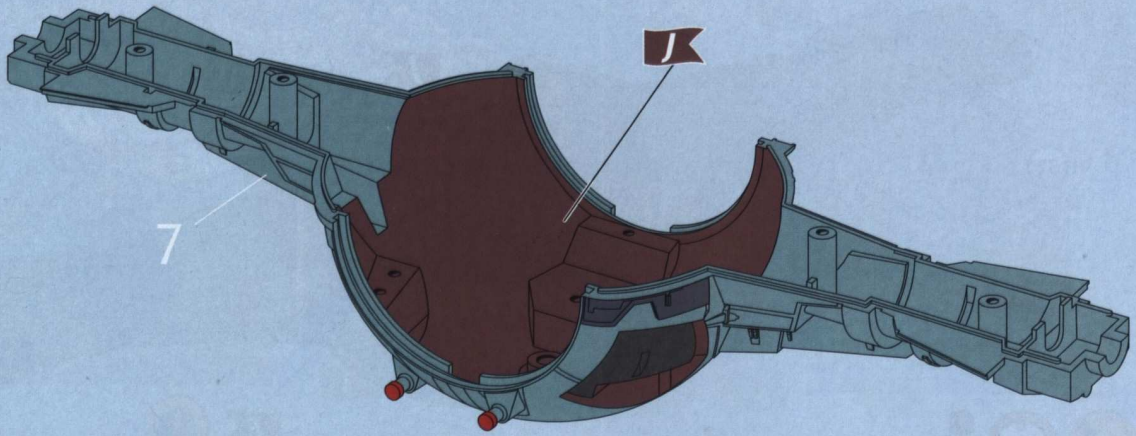

9    

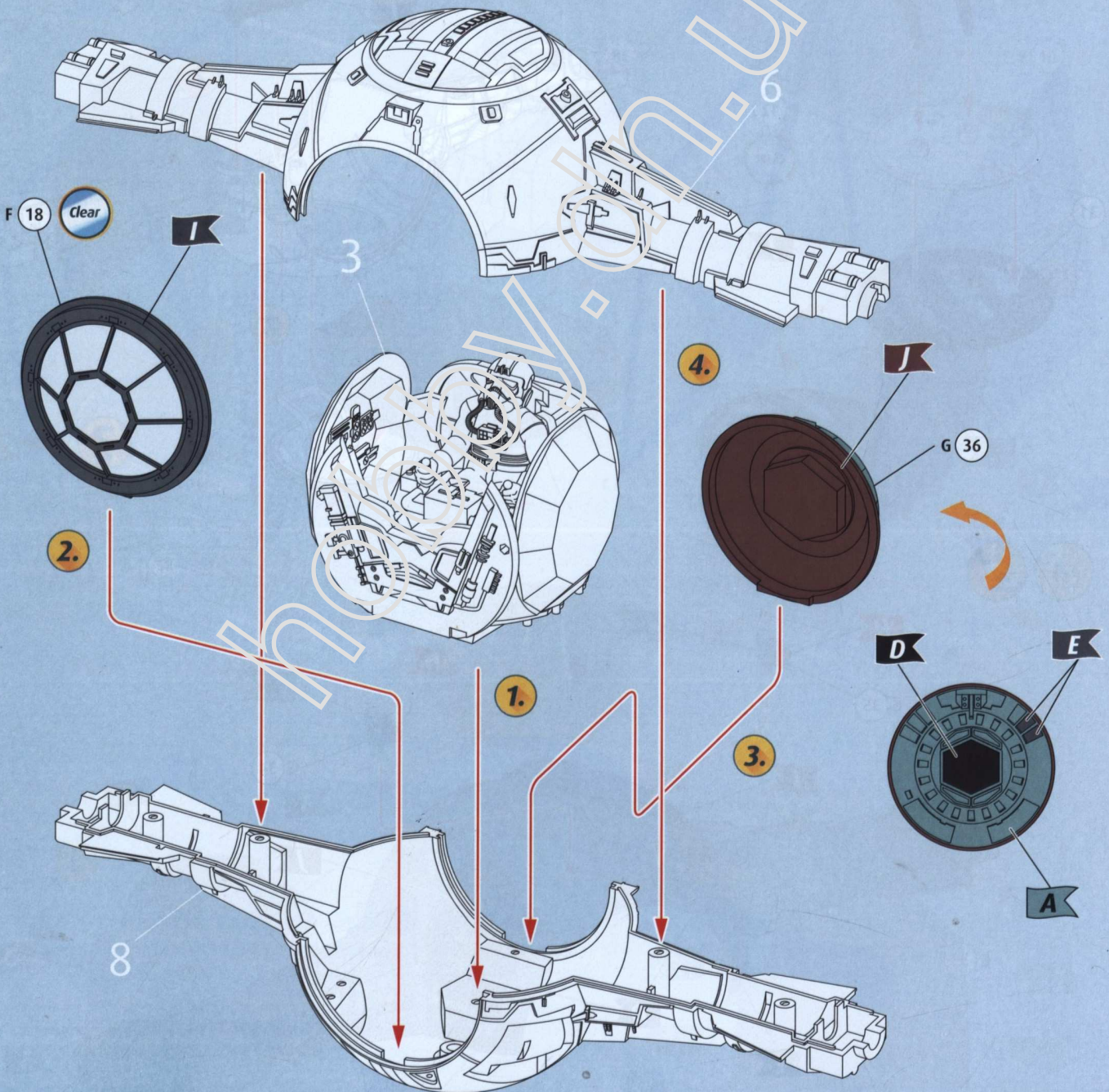

10 

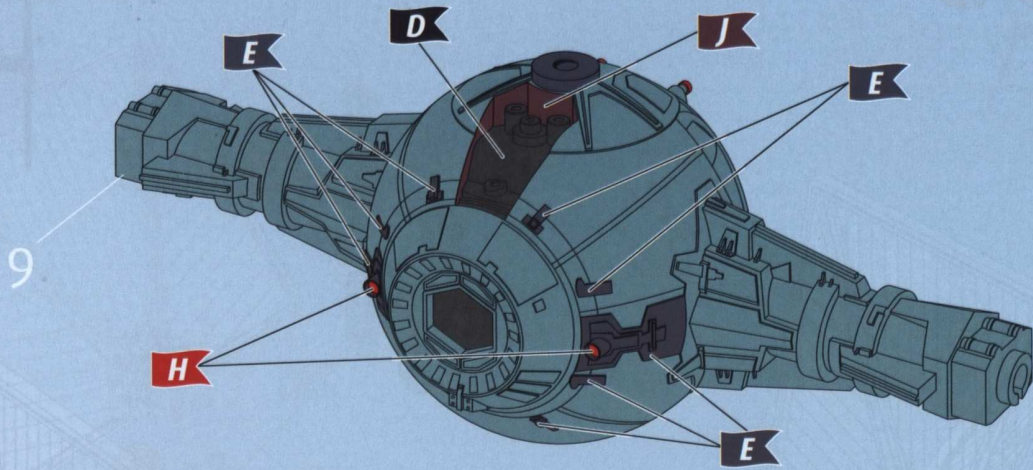

11    2X

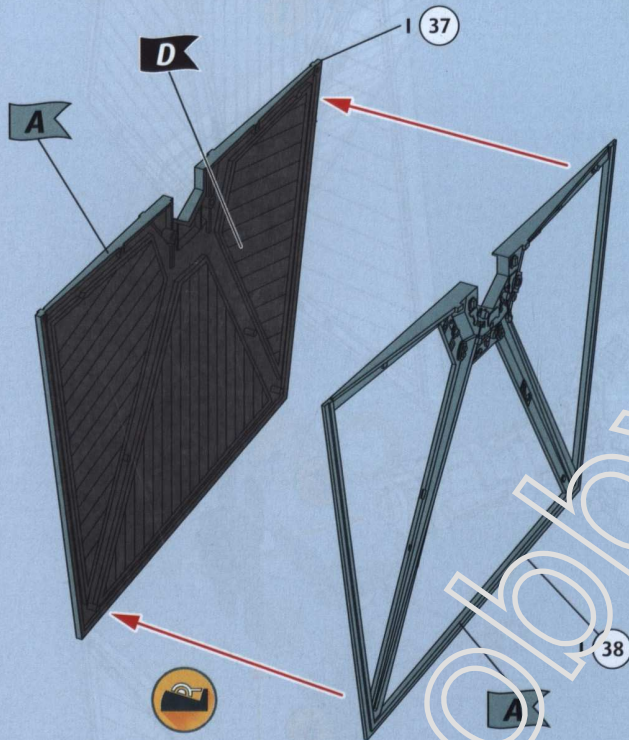

12   

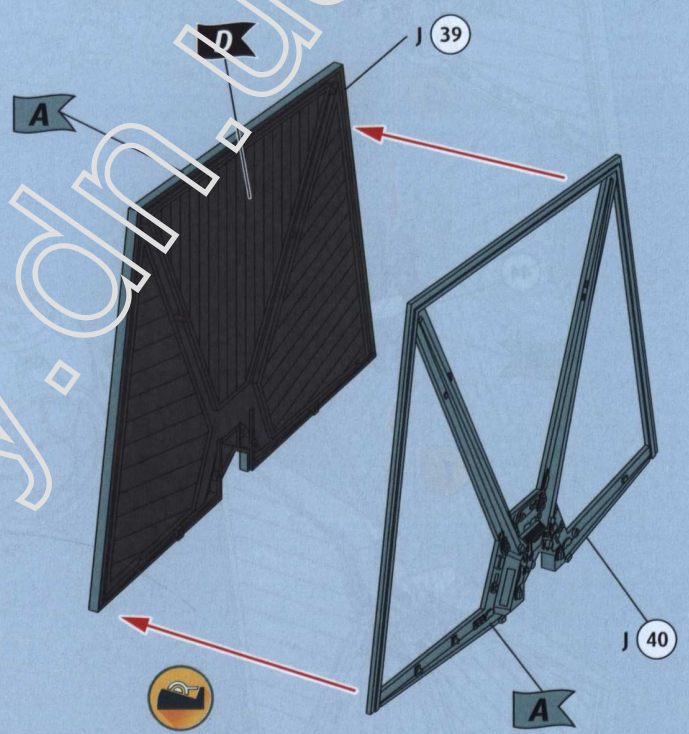

13   

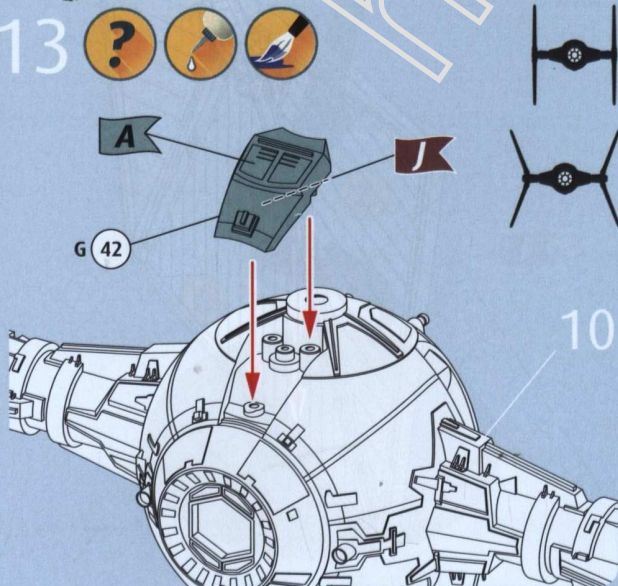

14   

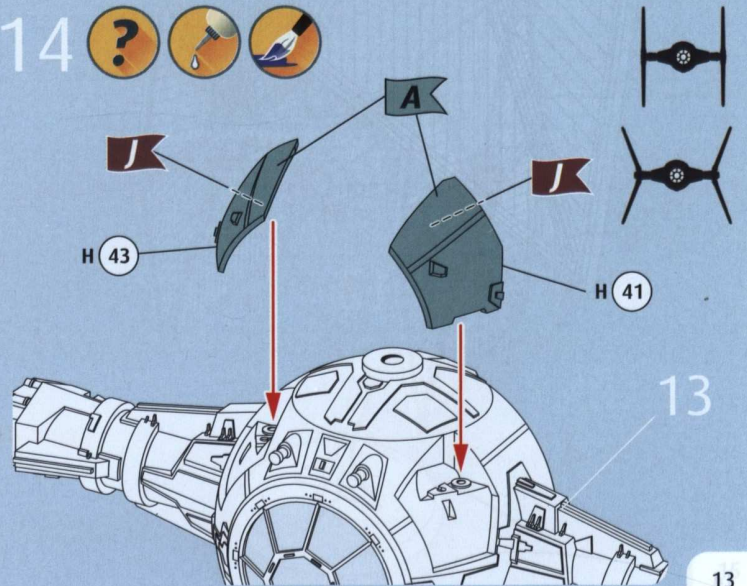



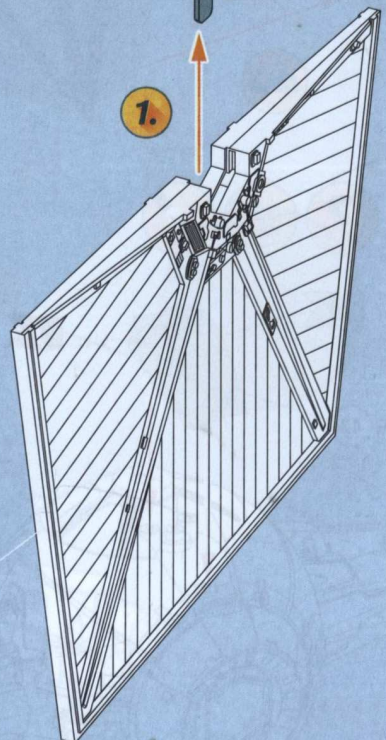
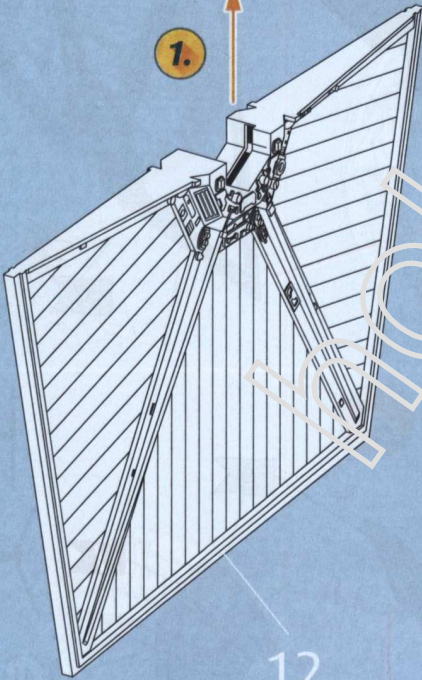
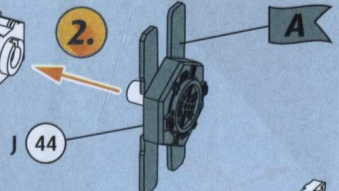
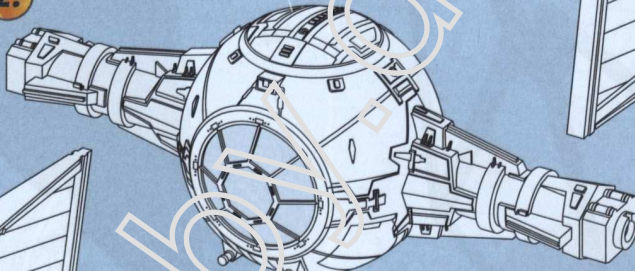
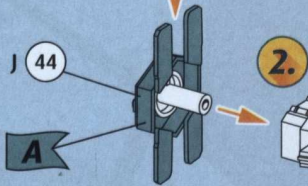
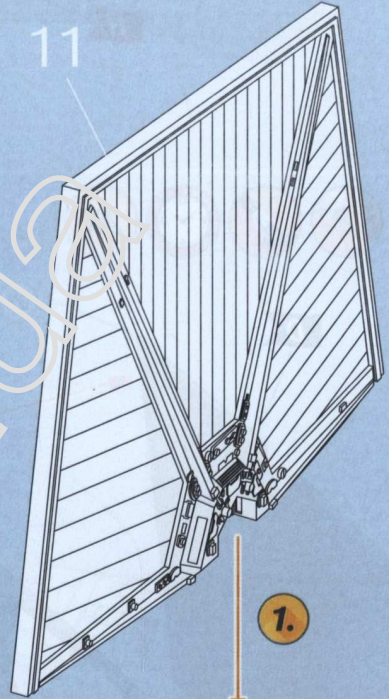
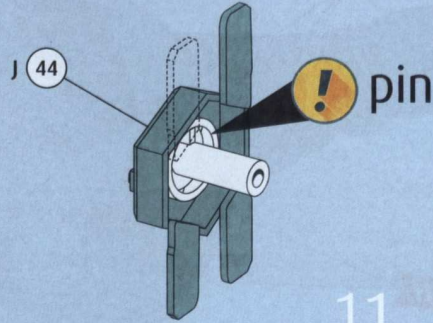
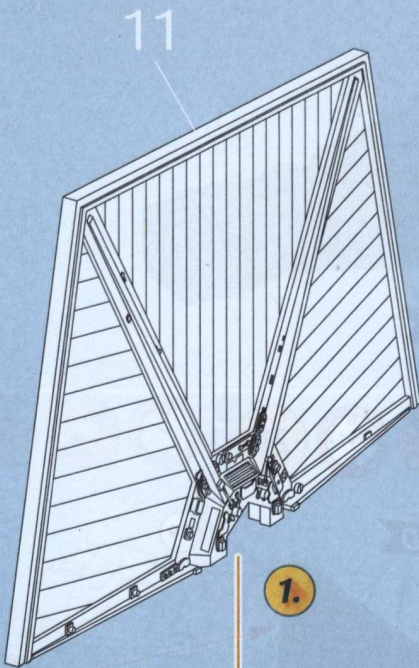
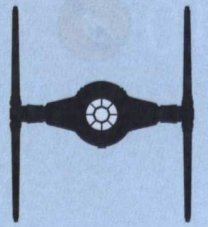

16

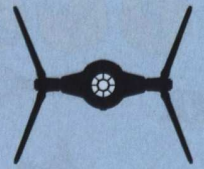

17

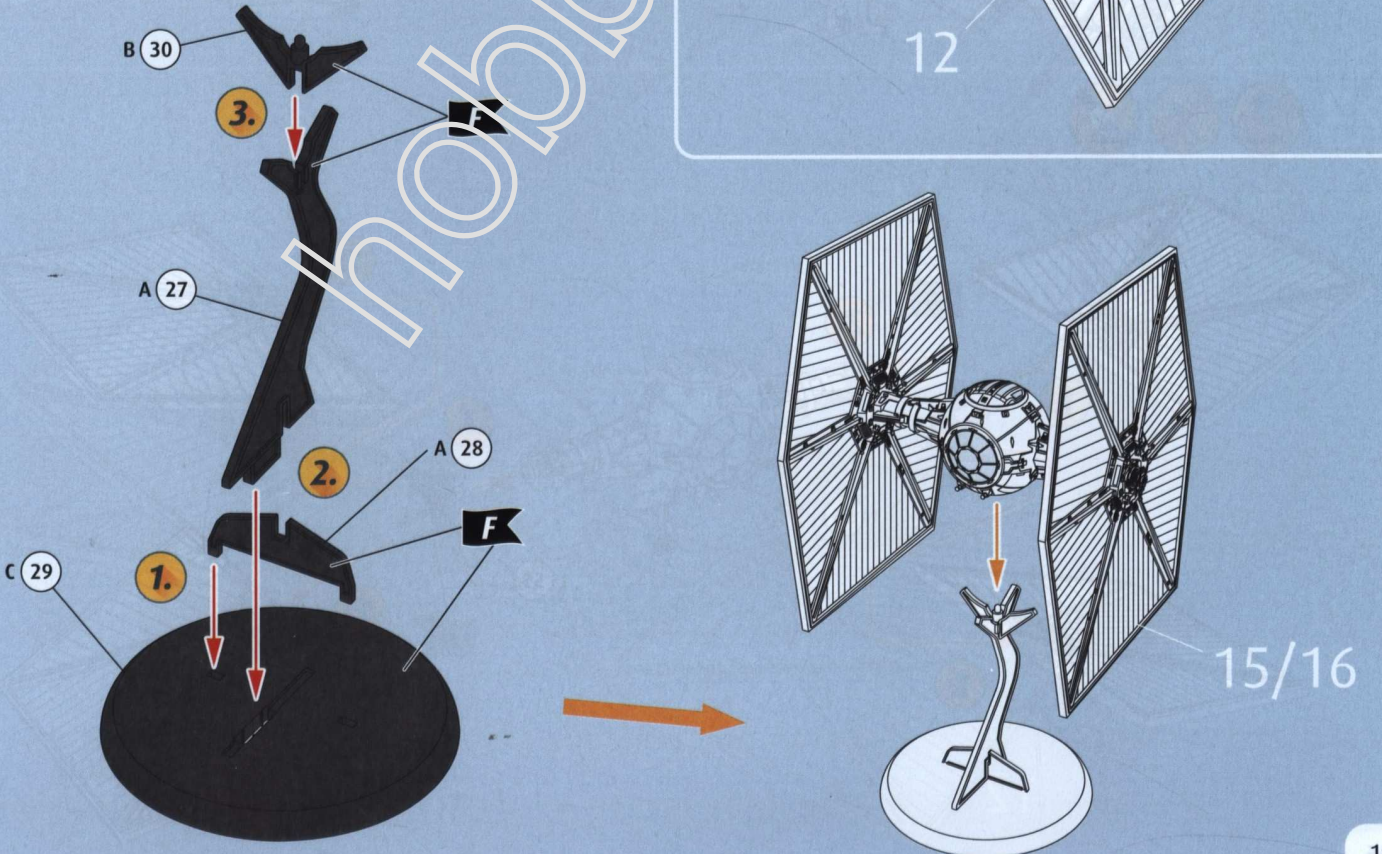

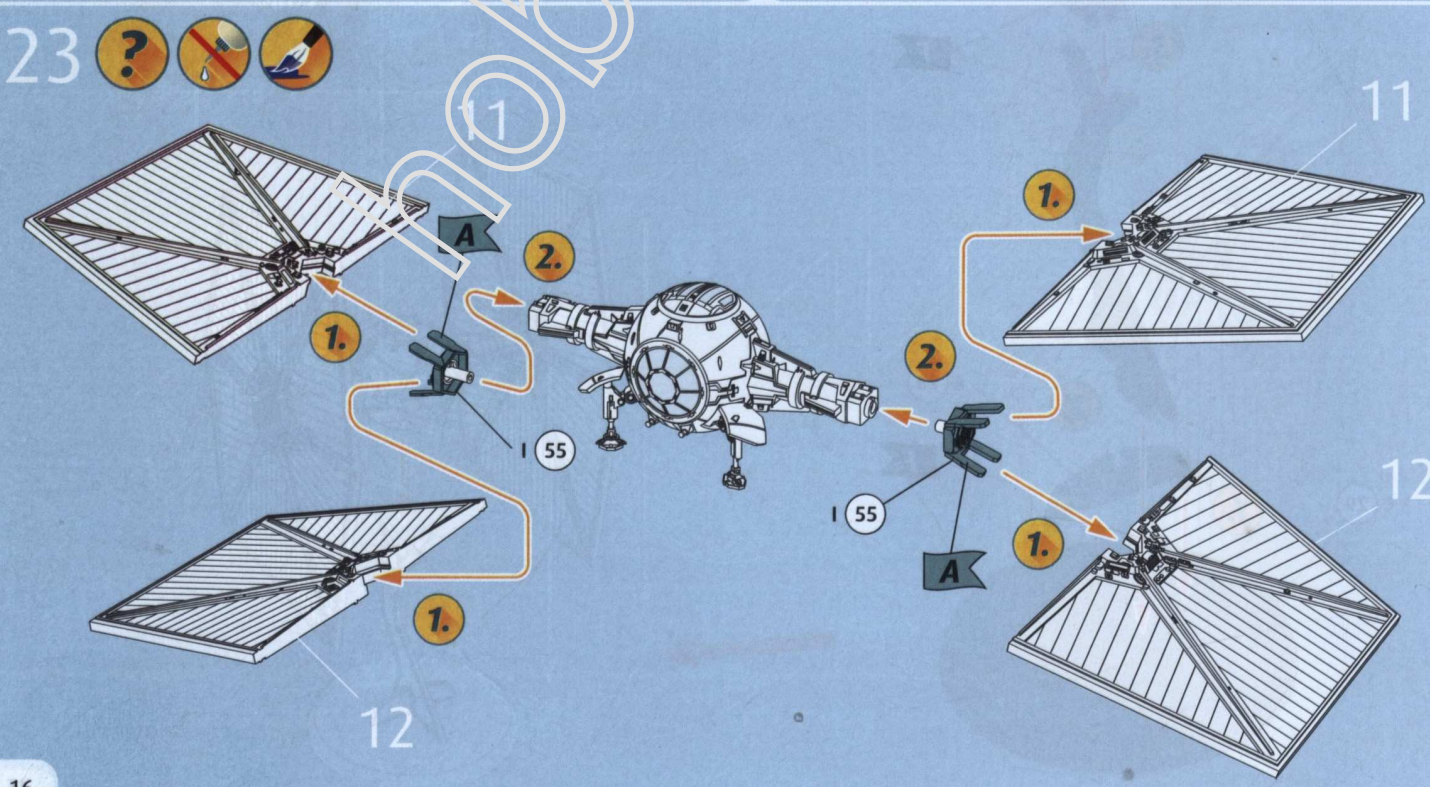
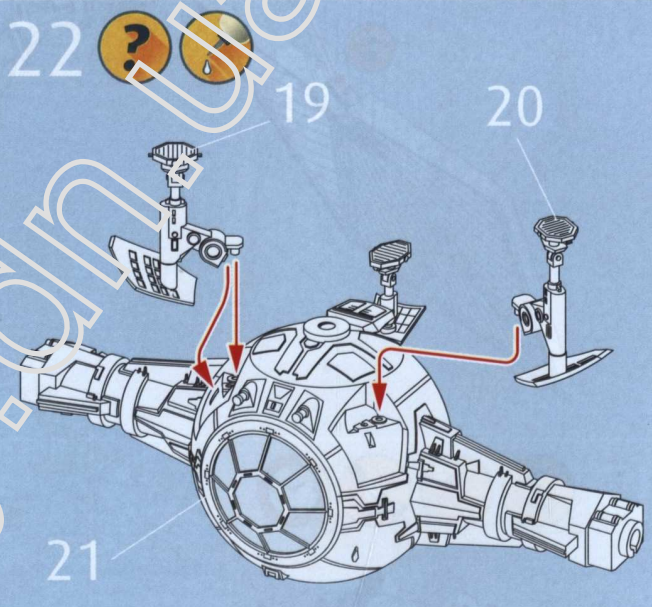
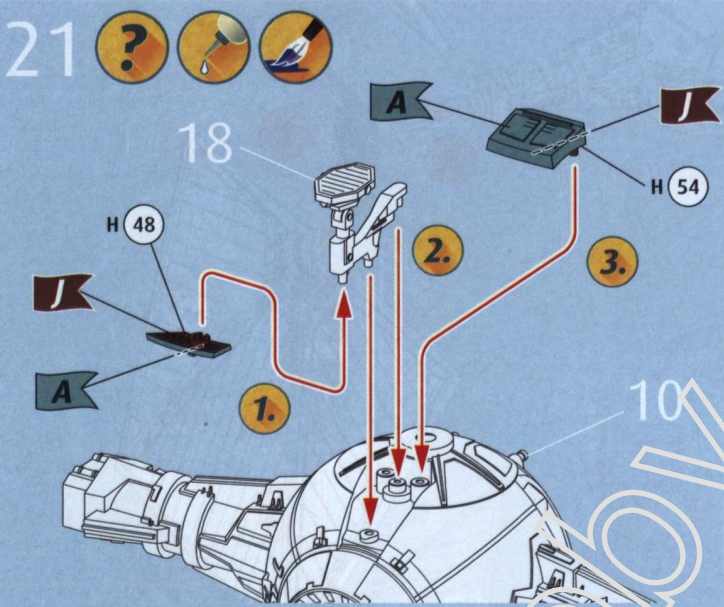
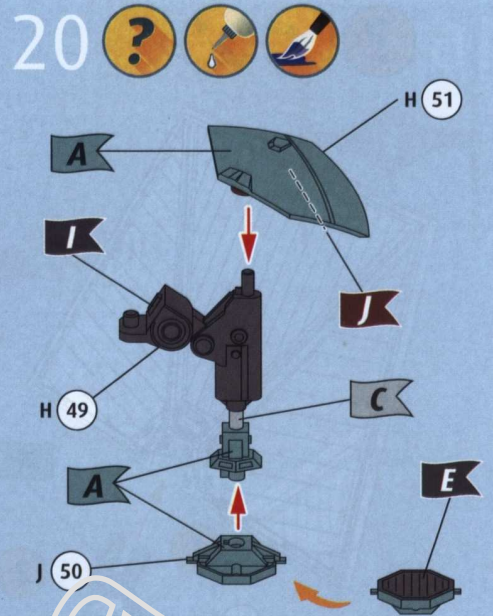
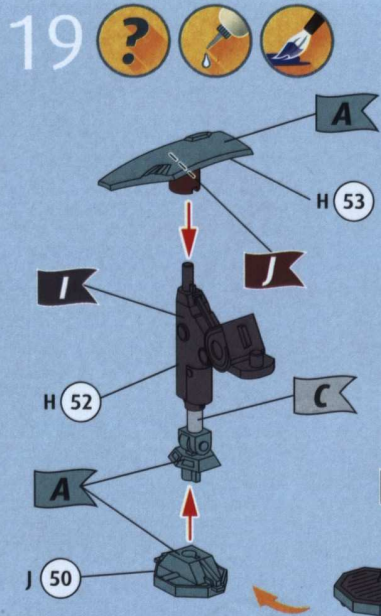
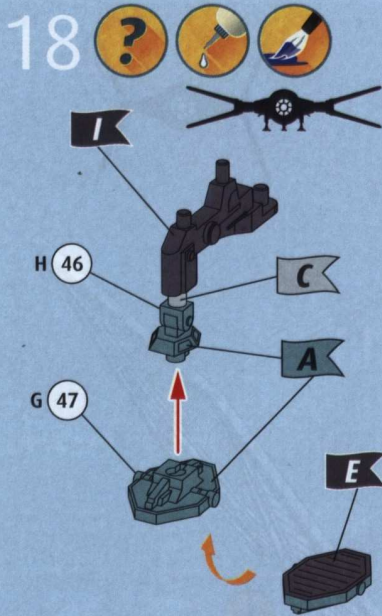

Option 1 - in flight, vertical wings

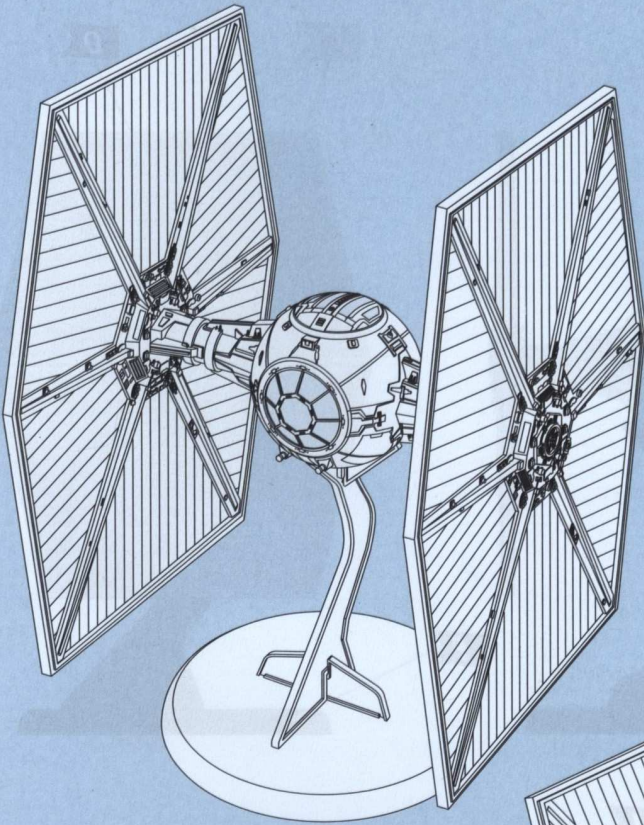

Option 2 - in flight, partly folded wings

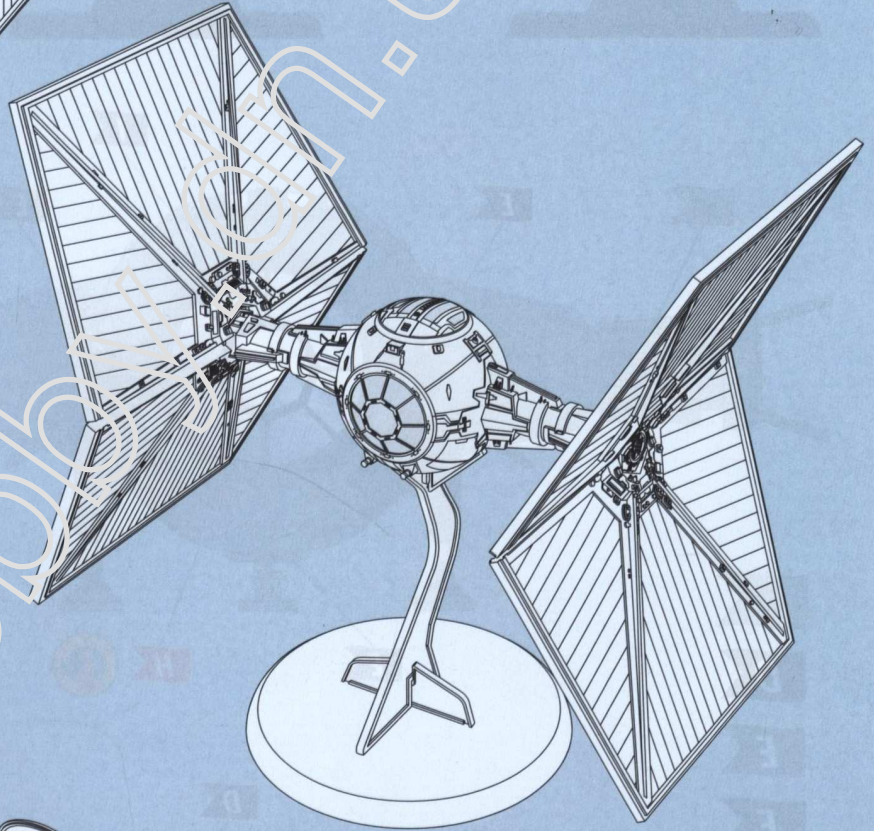

Option 3 - landed

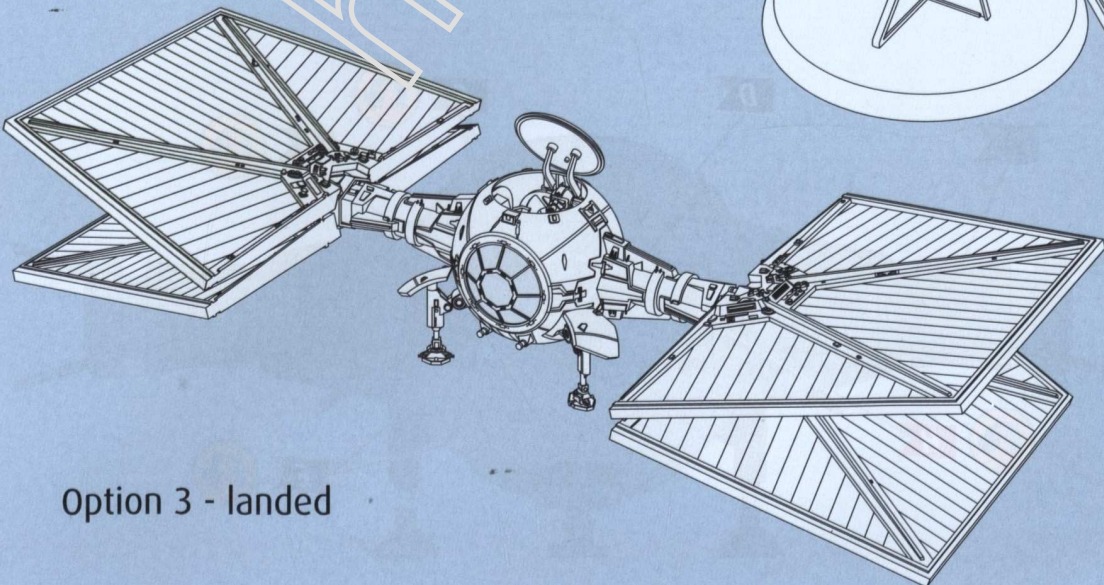

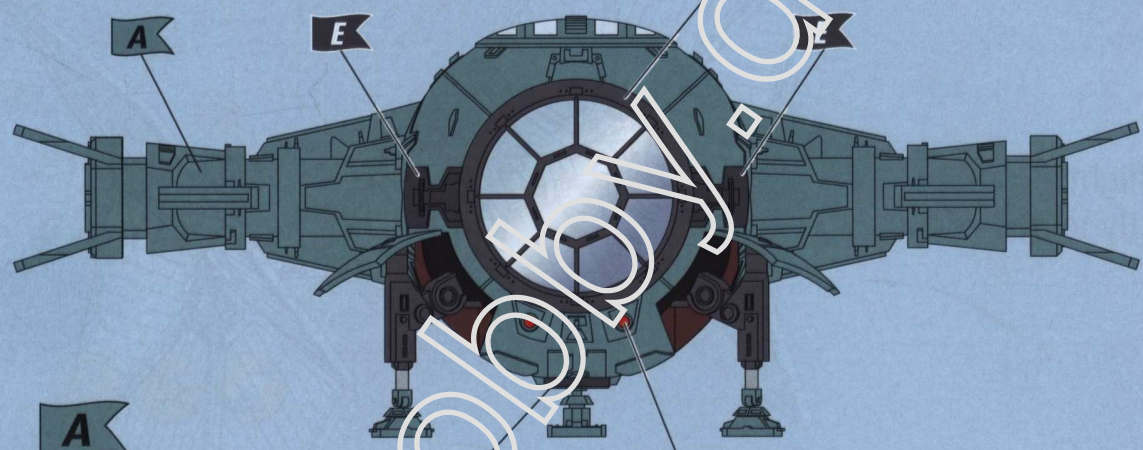
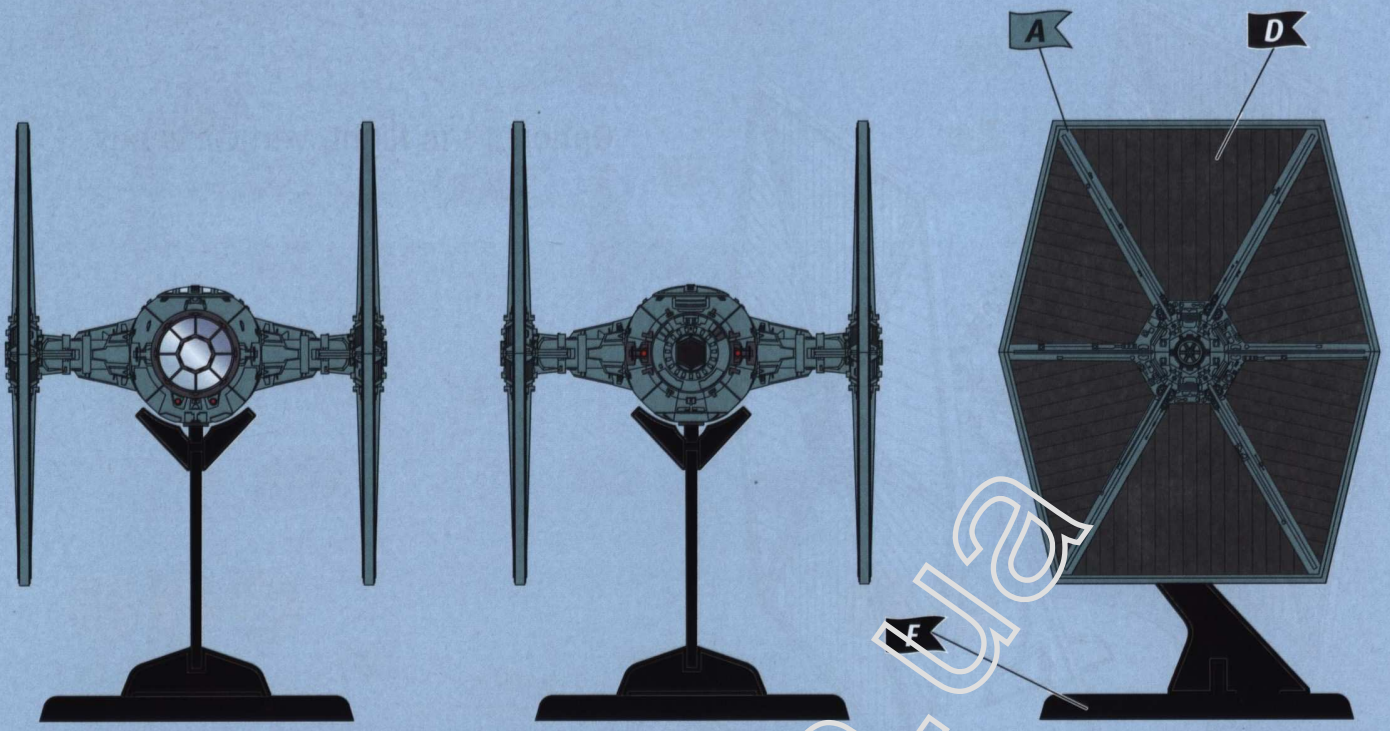

- A
- D
- E
- F
- H
- I

